

**CBN400.1**  
**Isolating Measurement Probe**  
User's Guide



## Copyright

---

The data in this document may not be altered or amended without special notification from ETAS GmbH. ETAS GmbH undertakes no further obligation in relation to this document. The software described in it can only be used if the customer is in possession of a general license agreement or single license. Using and copying is only allowed in concurrence with the specifications stipulated in the contract.

Under no circumstances may any part of this document be copied, reproduced, transmitted, stored in a retrieval system or translated into another language without the express written permission of ETAS GmbH.

© **Copyright 2016** ETAS GmbH, Stuttgart

The names and designations used in this document are trademarks or brands belonging to the respective owners.

CBN400.1 - User's Guide R04 EN - 02.2016

---

## Contents

<b>1</b>	General	5
<b>1.1</b>	Basic Safety Instructions	5
<b>1.1.1</b>	Labeling of Safety Instructions	5
<b>1.1.2</b>	General safety information	5
<b>1.1.3</b>	Requirements for users and duties for operators	5
<b>1.1.4</b>	Correct Use	6
<b>1.2</b>	Identifications on the product	8
<b>1.3</b>	CE marking	8
<b>1.4</b>	Product return and recycling	8
<b>1.5</b>	RoHS conformity	9
<b>1.5.1</b>	European Union	9
<b>1.5.2</b>	China	9
<b>1.6</b>	About this manual	9
<b>1.6.1</b>	Organization	9
<b>1.6.2</b>	Working with the manual	10
<b>1.7</b>	Scope of supplies	10
<b>2</b>	Hardware Description	11
<b>2.1</b>	Overview	11
<b>2.1.1</b>	Combined use with the ES411.1 A/D module	11
<b>2.1.2</b>	Properties	12
<b>2.2</b>	Assemblies and function	13
<b>2.2.1</b>	Design of the Isolating Measurement Probe	13
<b>2.2.2</b>	Measuring channels	13
<b>2.2.3</b>	Housing of the measuring channels	13
<b>2.2.4</b>	Connections and cabling	14
<b>2.2.5</b>	Operating voltage	14
<b>2.2.6</b>	Cable identification	15
<b>2.2.7</b>	Serial number	15

<b>2.3</b>	Applications .....	16
<b>3</b>	Technical data .....	17
<b>3.1</b>	General data .....	17
<b>3.1.1</b>	Standards and guidelines met .....	17
<b>3.1.2</b>	Type check .....	18
<b>3.1.3</b>	Usage .....	18
<b>3.1.4</b>	Ambient conditions .....	18
<b>3.1.5</b>	Power supply .....	18
<b>3.2</b>	System requirements .....	19
<b>3.2.1</b>	Hardware .....	19
<b>3.2.2</b>	Software .....	19
<b>3.3</b>	Electrical data .....	21
<b>3.4</b>	Mechanical data .....	22
<b>3.5</b>	Mapping of measuring channels .....	22
<b>4</b>	Ordering Information .....	23
<b>5</b>	ETAS Contact Addresses .....	25
	Figures .....	27
	Index .....	29

## 1 General

---

The introductory chapter informs you about the basic safety information, product return and recycling, the use of this manual, the scope of delivery and other information.

### 1.1 Basic Safety Instructions

---

#### 1.1.1 Labeling of Safety Instructions

---

The safety instructions contained in this manual are identified by the general danger symbol shown below:



The safety instructions shown below are used for this purpose. They provide notes about extremely important information. Please read this information very carefully.

**DANGER!**

*Identifies an immediate danger with high risk, which could result in death or severe bodily injury if it is not avoided.*

**WARNING!**

*Identifies a possible danger with medium risk, which could result in death or (severe) bodily injury if it is not avoided.*

**CAUTION!**

*Identifies a danger with low risk that could result in slight or moderate bodily injuries or property damage if it is not avoided.*

#### 1.1.2 General safety information

---

Please observe the product safety advice ("ETAS Safety Advice CBN" and the subsequent safety instructions to avoid any impact on your health or damages to the device.

**Note**

*Carefully read the documentation that belongs to the product (ETAS Safety Advice CBN and this User's Guide) prior to the startup.*

ETAS GmbH does not assume any liability for damages resulting from improper handling, unintended use or non-observance of the safety precautions.

#### 1.1.3 Requirements for users and duties for operators

---

The Isolating Measurement Probe product may be commissioned and used only by qualified electricians for high-voltage systems (BGI/GUV-I 8686 of the DGUV, minimum Level 2).

The product may be assembled, operated and maintained only if you have the necessary qualification and experience for this product. Improper use or use by a user without sufficient qualification can lead to damages or injuries to one's health or damages to property.

#### *General safety at work*

---

The existing regulations for safety at work and accident prevention must be followed.

#### 1.1.4 Correct Use

---

This product has been developed and released for use in automotive applications. For usage in other domains please contact your ETAS representative.

#### *Requirements for Operation*

---

**WARNING!**

*This is a class A product. In a domestic environment this product may cause radio interference in which case the user may be required to take adequate measures.*

**WARNING!**

*Check before each use of the product in high-voltage systems its function by measuring a known extra-low voltage.*

The following requirements are put in place for safe operation:

- The Isolating Measurement Probe product meets the requirements of protection class IP65. Observe the notes for the ambient conditions (see chapter 3.1.4 on page 18).
- Use the product only according to the specifications in the corresponding user's guide. For any other use, the product safety is not ensured.
- This product must not be used for measuring of mains supply circuits.
- Observe the regulations concerning electrical safety and the laws and regulations concerning occupational safety applicable at the application site!
- Observe the rules for working on equipment with dangerous voltages!
- Carefully attach the high-voltage measuring cables.
- Keep the high-voltage measuring lines short to minimize the risks of injuries from pinching, contracting, scoring or shearing.
- Do not use the product in a wet or humid environment.
- Do not use the product in a potentially explosive atmosphere.
- Keep the surfaces of the product clean and dry.

#### *Requirements for the technical State of the Product*

---

The product is designed in accordance with state-of-the-art technology and recognized safety rules. The product may be operated only in a technically flawless condition and according to the intended purpose and with regard to safety and

dangers as stated in the respective product documentation. If the product is not used according to its intended purpose, the protection of the product may be impaired.

**DANGER!*****Risk of electric shock with damaged housing of a measuring channel or damaged insulation of a high-voltage cable!***

*Electric shock upon touching energized components of the Isolating Measurement Probe leads to injuries, heart failure or death.*

*A damaged Isolating Measurement Probe must be decommissioned **immediately!***

***Ensure that the damaged Isolating Measurement Probe is not longer being used!***

*A repair of the Isolating Measurement Probe is not possible, attempts to repair are not permissible!*







#### *Maintenance and cleaning*

---

The product is maintenance-free. For cleaning, use a clean and dry cloth.

## 1.2 Identifications on the product

The high-voltage side of the housings of the measuring channels of the CBN400.1 Isolating Measurement Probe is identified in orange. The following symbols are used for identifying the product:

Symbol	Description
	Prior to operating the product, be sure to read the user's guide!
840 V	Maximum input voltage 840 V
	Measuring input, minus
	Measuring input, plus
	Housing protected with double insulation (acc. to EN 61010-1)
	Identification for RoHS, see chapter 1.5.1 on page 9
	Identification for China RoHS, see chapter 1.5.2 on page 9

Observe the information in chapter "Technical data" on page 17.

## 1.3 CE marking

ETAS confirms that the product meets the product-specific applicable European Directives with the CE marking affixed to the product or its packaging. The CE Declaration of Conformity for the product is available upon request.

## 1.4 Product return and recycling

The European Union (EU) issued the Waste Electrical and Electronic Equipment (WEEE) Directive to ensure the setup of systems for collecting, handling and processing electronic waste in all countries of the EU.



This ensures that the equipment is recycled in a resource-saving manner that does not represent any risk for the health and safety of humans and the environment.



**Fig. 1-1** WEEE symbol

The WEEE symbol (see Fig. 1-1 on page 9) on the product or its packaging identifies that the product may not be disposed of together with garbage.

The user is obligated to collect used equipment separately and provide them to the WEEE return system for recycling.

The WEEE directive relates to all ETAS equipment, but not to external cables or batteries.

Additional information about the recycling program of ETAS GmbH can be obtained from the ETAS sales and service branch offices (see chapter 5 on page 25).

## 1.5 RoHS conformity

---

### 1.5.1 European Union

---

The EU Directive 2002/95/EU limits the use of certain dangerous materials for electrical and electronic devices (RoHS conformity).

ETAS confirms that the product corresponds to this directive which is applicable in the European Union.

### 1.5.2 China

---

ETAS confirms that the product meets the product-specific applicable guidelines of the China RoHS (Management Methods for Controlling Pollution Caused by Electronic Information Products Regulation) applicable in China with the China RoHS marking affixed to the product or its packaging.

## 1.6 About this manual

---

This manual describes the startup and technical data of the CBN400.1 Isolating Measurement Probe product.

### 1.6.1 Organization

---

The manual consists of four chapters and one index.

- **Chapter 1: "General"**

The "General" chapter (this chapter) informs you about the basic safety information, product return and recycling, the use of this manual, the scope of delivery and other information.

- **Chapter 2: "Hardware Description"**

The "Hardware description" chapter provides an overview of the CBN400.1 Isolating Measurement Probe and information about the power supply, the measuring channels and their housing, the connections and cabling, the cable identification and the serial number.

- **Chapter 3: "Technical Data"**

The "Technical data" chapter describes the standards and guidelines that have been met, the ambient conditions, the application area, the system requirements for operating the CBN400.1 Isolating Measurement Probe, the electrical data, the mechanical data, and the mapping of the measuring channels.

- **Chapter 4: "Ordering Information"**

The "Ordering Information" chapter includes the ordering information for the available cables and the accessories.

The concluding chapter "ETAS Contacts" gives you information about the international ETAS sales and service branch offices.

## 1.6.2 Working with the manual

---

### *Typographical conventions*

---

The following typographical conventions are used:

<b>Bold</b>	Labels of the device
<i>Italics</i>	Particularly important text passages

Important notes for the user are represented as follows:

**Note**

*Important note for users.*

## 1.7 Scope of supplies

---

Before the initial startup of your CBN400.1 Isolating Measurement Probe, please verify that the device has been delivered with all the required parts (see the chapter "Ordering Information" on page 23).

## 2 Hardware Description

This chapter provides an overview of the Isolating Measurement Probe CBN400.1 and information about housing, serial number and connections.

### 2.1 Overview

#### 2.1.1 Combined use with the ES411.1 A/D module

The signal conditioning cable Isolating Measurement Probe CBN400.1 consists of four identical active voltage measuring channels that are integrated in a splitter cable and designed for combined use with the ES411.1 A/D module. The combination with the Isolating Measurement Probe expands the four channels of the ES411.1 module by the application area of **isolated** measuring of voltages up to 840 V, e.g. in the high-voltage on-board system of hybrid and electric vehicle systems.



**Fig. 2-1** CBN400.1 with ES411.1 A/D module

The electrical isolation between the voltage in the high-voltage on-board system and the ES411.1 module is done close to the measuring point separately in each of the measuring channels of the CBN400.1.

Integrating the CBN400.1 Isolating Measurement Probe in the ETAS measuring system and in INCA provides an efficient solution for acquiring voltages during the development, application and validation of electronic controls of the electric drive.

#### **Note**

*The CBN400.1 Isolating Measurement Probe is designed only for use with the ES411.1 A/D Module, with the ES415.1 A/D Module and with the ES441.1 Counter and Frequency Module. In this user's guide the ES411.1 A/D Module is used as example. Insofar as not otherwise noted, the descriptions apply to all modules.*

### 2.1.2 Properties

---

The most important properties of the CBN400.1 Isolating Measurement Probe, combined with the ES411.1 module:

- Use in combination with the ES411.1 A/D module
- Insulating compact probes for acquiring voltages in the high-voltage on-board system of hybrid or electric vehicles
- High degree of safety through electrical isolation close to the measuring point
- Electrical isolation up to 840 V potential difference
- 840 V measurement range for acquiring on-board system voltages
- Suitable for measuring directly on the inverter and the e-machine
- Voltage supply integrated in the measuring cable
- When used with ETAS application software
  - Automatic setting of the voltage supply of the Isolating Measurement Probe through the ES411.1 A/D module,
  - Automatic transfer of the individual adjustment and calibration values for the combination of Isolating Measurement Probe and ES411.1 module,
  - Automatic setting of the measurement range for the Isolating Measurement Probe in INCA
- Synchronous acquisition of control unit signals and other measuring data from the vehicle environment
- Automotive-ready product that is suitable for the use in the development environment and in the vehicle on test tracks.
  - Neutral to environmental conditions (temperature, EMC),
  - High mechanical stability and robustness
- Product safety through type check and certification by an accredited test lab
- Together with the ES411.1 module part of the ETAS Tool Suite

The complete technical data of the CBN400.1 can be found in chapter "Technical data" on page 17.

2.2 Assemblies and function

2.2.1 Design of the Isolating Measurement Probe

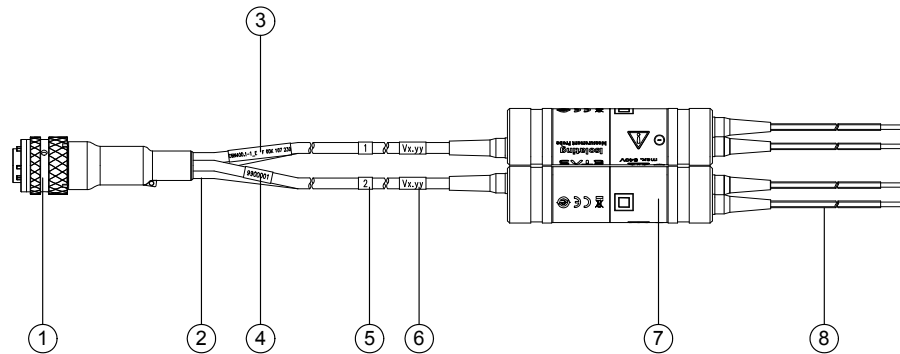

**Fig. 2-2** Design of the Isolating Measurement Probe

No. in Fig. 2-2	Term
1	Souriau plug
2	Splitter cable
3	Type part number of product
4	Serial number of product
5	Number of measuring channel
6	Hardware version number of product
7	Housing of measuring channel
8	Measuring lines

The Isolating Measurement Probe CBN400.1 is equipped with a splitter cable at a Souriau plug (left) which is connected with the low-voltage side of the four measuring channel housings (center). On the high-voltage side, each measuring channel features two measuring lines (right).

2.2.2 Measuring channels

Each of the four measuring channels is encapsulated in a separate, insulating cylindrical housing that contains the electronics and electrical isolation of the measuring channel (see Fig. 2-2 on page 13).

The signal conditioning, voltage reduction and potential isolation of the high-voltage signals from the low-voltage side takes place in the housings of the measuring channels.

2.2.3 Housing of the measuring channels

*Identification of the high-voltage side*

The high-voltage side of the housings of the measuring channels is identified in orange.

*Design of the housings*

The housings of the four adapters are designed identically.

### *Mechanical damage of a housing*

---

With mechanical damage of the outside **blue** layer of a measuring channel housing, the underlying **black** filling compound in this area is visible.



#### **DANGER!**

#### ***Risk of electric shock with damaged housing of a measuring channel or damaged insulation of a high-voltage cable!***

*Electric shock upon touching energized components of the Isolating Measurement Probe leads to injuries, heart failure or death.*

*A damaged Isolating Measurement Probe must be decommissioned **immediately!***

***Ensure that the damaged Isolating Measurement Probe is not longer being used!***

*A repair of the Isolating Measurement Probe is not possible, attempts to repair are not permissible!*

## 2.2.4 Connections and cabling

---

### *Low-voltage side*

---

The low-voltage side of the CBN400.1 Isolating Measurement Probe is located at the Souriau plug which is connected to the ES411.1 A/D module.

### *High-voltage side*

---

The lines on the high-voltage side are marked with red/orange ("+" input) and black/orange ("- " input).

To minimize dangers on the high-voltage side through long cables, short cables are used as a connection to the housings of the measuring channels. Longer connections in the measuring setup can, therefore, be implemented on the electrically isolated low-voltage side.

For the contacts in the measuring setup, the user can shorten or modify the cable ends of the measuring channels as needed on the high-voltage side (see Fig. 2-2 on page 13). A very compact setup in the high-voltage area enables a high operational reliability.

#### **Note**

*For this reason, observe the regulations and rules for working on high-voltage systems.*

The mechanical design of the CBN400.1 Isolating Measurement Probe guarantees short cables between the electronics of the measuring channel and the measuring point (see Fig. 3-1 on page 22).

## 2.2.5 Operating voltage

---

The ES411.1 A/D module with sensor supply provides the Isolating Measurement Probe CBN400.1 with operating voltage. The output voltage of the ES411.1 module (sensor supply voltage of the module) is used as voltage supply of the Isolating Measurement Probe.

Since a separate sensor supply connection exists on the ES411.1 A/D module for each measuring channel of the module, each of the four measuring channels of the CBN400.1 is supplied separately with operating voltage. The power supply cables of the Isolating Measurement Probe are integrated in the measuring cable.

## 2.2.6 Cable identification

---

### *Functions for use of ETAS application software*

---

If the combination of Isolating Measurement Probe and ES411.1 module is operated with an ETAS application software (INCA), the following automatic functions are implemented for each measuring channel:

- Automatic setting of the voltage supply of the Isolating Measurement Probe through the ES411.1 A/D module,
- Automatic transfer of the individual adjustment and calibration values for the combination of Isolating Measurement Probe and ES411.1 module,
- Automatic setting of the measurement range for the Isolating Measurement Probe in INCA.

These functions are implemented individually in each measuring channel with technologies that use methods based on the TEDS standard.

### *Limitations on the use of customer-based application software*

---

If the combination of Isolating Measurement Probe and ES411.1 module is operated with a customer-based application software, the use of the product is limited and possible only with higher effort:

- The output voltage of the ES411.1 module (sensor supply voltage of the module), which is used as voltage supply of the Isolating Measurement Probe, must be manually set to 12 V.
- Adjustment and calibration values for the combination of Isolating Measurement Probe and ES411.1 module must be manually entered for each module by the user in the customer-based application software.  
ETAS provides these values upon request.
- The information required for automatic adjustment of the measurement range for the Isolating Measurement Probe can be read out from the ES411.1 module only by means of the ETAS application software. For this reason, customers who are using their own application software must adjust the measurement ranges manually.

## 2.2.7 Serial number

---

The serial number of the CBN400.1 Isolating Measurement Probe is located close to the Souriau plug on the splitter cable (no. 4 in Fig. 2-2 on page 13). It is required if you are contacting the technical customer service of ETAS.

In the application software, the serial number of the CBN400.1 Isolating Measurement Probe is not used.

## 2.3 Applications

**WARNING!**

Check before each use of the product in high-voltage systems its function by measuring a known extra-low voltage.

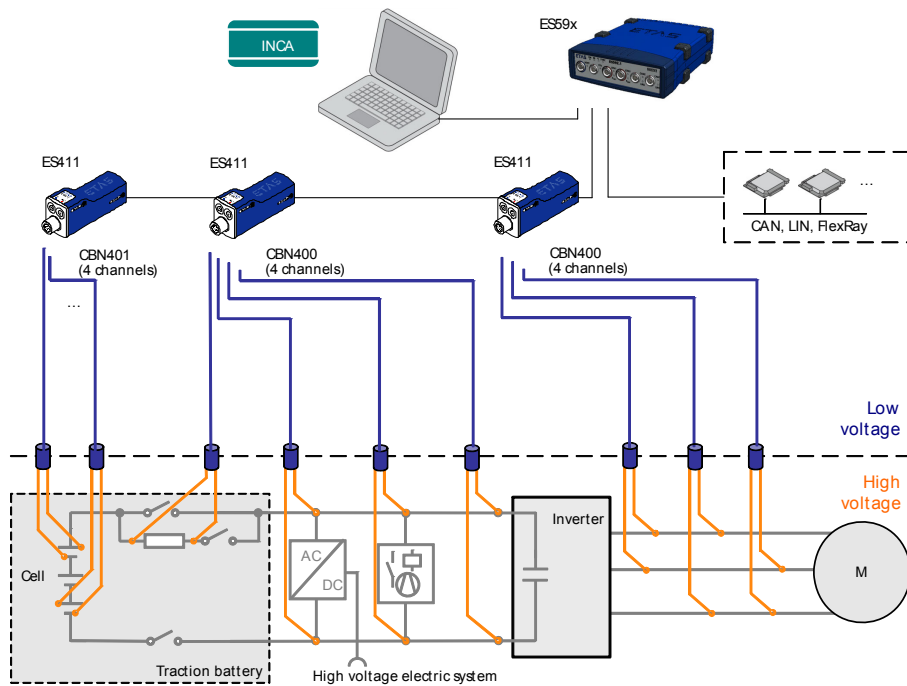

**Fig. 2-3** Use of the CBN400.1 and the CBN401.1 in the high-voltage on-board system

Typical applications are monitoring voltages in the high-voltage on-board system, e.g. at the drive battery, at individual cells of the drive battery or at DC links (see Fig. 2-3 on page 16). The voltage measurements can be used, for example, to acquire the charge state of the drive battery, the behavior of the battery under load, oscillations in the high-voltage on-board system or the purposeful discharge of the battery in safety-critical situations independent of the ECU.



### 3 Technical data

This chapter describes the standards and guidelines that have been met, the ambient conditions, mechanical data, system requirements for operating the CBN400.1 Isolating Measurement Probe and the electrical data.

#### **Note**

*Information about the ES411.1 module is located in the "ES411.1 A/D Module with Sensor Supply" user's guide.*

#### 3.1 General data

##### 3.1.1 Standards and guidelines met

The Isolating Measurement Probe CBN400.1 connected to the ES411.1 module corresponds to the following standards and guidelines:

<b>Standard</b>	<b>Test</b>
EN 61010-1	Safety regulations for electrical measurement, control and laboratory use
EN 61326	Electrical equipment for measurement, control and laboratory use - EMC requirements
EN 61000-6-2	Interference immunity (industrial environment) <sup>1)</sup>
EN 61000-6-4	Interference emission (industrial environments)

<sup>1)</sup>: The module must be supplied by a DC power supply or a battery with operating voltage. Between module and voltage source, cables with a maximum length of 30 m are allowed.

The Isolating Measurement Probe CBN400.1 is designed only for use in industrial areas acc. to EN 61000-6-4. Avoid possible radio interferences when using the Isolating Measurement Probe outside of industrial environments through additional suppression measures!



#### **WARNING!**

*This is an equipment of Class A. This equipment may cause radio interferences in residential areas. In this case, the user may be required to perform appropriate measures.*



#### **CAUTION!**

##### **Loss of properties acc. to IP65!**

*Do not open or change the housing of the ES411.1 module! Work on the housing may be performed only by qualified technical personnel.*

3.1.2 Type check

---

The CBN400.1 Isolating Measurement Probe was checked by an accredited test lab with respect to type and certified. Information about the type check of the product are available from ETAS upon request.

3.1.3 Usage

---



**WARNING!**

*Check before each use of the product in high-voltage systems its function by measuring a known extra-low voltage.*



**WARNING!**

***Dependency of the maximum permissible input voltage of the CBN400.1 Isolating Measurement Probe on the application altitude!***

*The maximum permissible input voltage of the CBN400.1 Isolating Measurement Probe depends on its application altitude above MSL (see chapter 3.3 on page 21)!*

3.1.4 Ambient conditions

---

Operating temperature range	-40 °C to +75 °C -40 °F to +167 °F
Altitude	max. 5,000 m / 16,400 ft
Relative humidity (non-condensing)	0 to 95%
Protection class	IP65

3.1.5 Power supply

---

The ES411.1 A/D module with sensor supply provides the CBN400.1 Isolating Measurement Probe with operating voltage via the Souriau plug. No other cables are required. The output voltage of the ES411.1 module (sensor supply voltage of the module) is used as voltage supply of the Isolating Measurement Probe.

## 3.2 System requirements

---

### 3.2.1 Hardware

---

#### **Note**

The CBN400.1 Isolating Measurement Probe is designed only for use with the ES411.1 A/D Module, with the ES415.1 A/D Module and with the ES441.1 Counter and Frequency Module. In this user's guide the ES411.1 A/D Module is used as example. Insofar as not otherwise noted, the descriptions apply to all modules.

#### *Requirements on the hardware version of the module ES411.1*

---

For the combination of Isolating Measurement Probe and ES411.1 module to be fully supported in the application software, a compatible hardware version of the ES411.1 module is required.

#### **Note**

Check the hardware version of the module before using the Isolating Measurement Probe on the ES411.1 module.

A label with the hardware version of the module is located on the underside of the module. In addition, it is possible to read out the hardware version with the "HSP Update Tool" service software.

Hardware version	Remark	Function with Isolating Measurement Probe
V3.x and newer	Current HW version	Standard function
V2.x	Updated module	Standard function
V1.x	Older HW version	Hardware update required. Please send the module to ETAS.

#### *Requirements on the hardware version of the modules ES415.1 and ES441.1*

---

The combination of Isolating Measurement Probe and ES415.1 A/D Module or ES441.1 Counter and Frequency Module is supported in the application software by all hardware versions of this modules.

### 3.2.2 Software

---

#### *Requirements on the firmware of the module ES411.1*

---

For the Isolating Measurement Probe at ES411.1 modules to be supported, the ES411.1 module requires a firmware with expanded functionalities. This firmware is supplied with the "HSP Update Tool" service software of version V9.3.0 or higher.

Update the ES411.1 module with older firmware versions with HSP V9.3.0 or higher.

#### *Requirements on the firmware of the modules ES415.1 and ES441.1*

---

For the Isolating Measurement Probe at ES415.1 and ES441.1 modules to be supported, these modules require not any special firmware.

#### *Requirements for the application software*

---

For configuration as well as control and data acquisition of the ES411.1 in conjunction with the CBN400.1 Isolating Measurement Probe, you need an ES411.1 module with current firmware and software in the following versions:

- INCA V6.2.1 with INCA AddOn ES4xx V1.2.1 and higher  
or
- ES4xx Configuration Tool V1.2.1 and higher from ES4xx\_DRV\_SW (stand-alone operation)  
or
- Customers who use their own application software that does not support XCP-on-Ethernet, must supplement this software with a C-based library (C-API) for integrating XCP-on-Ethernet device drivers. The C-based library is available from ETAS.

#### **Note**

---

*Operating the CBN400.1 Isolating Measurement Probe connected to the ES411.1 module is not possible with older software versions.*

#### *Limitations on the use of customer-based application software*

---

If the combination of Isolating Measurement Probe and ES411.1 module is operated with a customer-based application software, the use of the product is limited and possible only with higher effort. Observe the notes in chapter 2.2.6 on page 15.

#### *Additional information*

---

The configuration instructions for the ES411.1 A/D module are located in the corresponding software documentation.

### 3.3 Electrical data

#### **Note**

ETAS guarantees that the measuring accuracy of the CBN400.1 Isolating Measurement Probe is maintained for one year.

#### **Note**

Unless specified otherwise, all data apply at 25 °C and for the operation of the CBN400.1 Isolating Measurement Probe with the module ES411.1.



#### **WARNING!**

**Dependency of the maximum permissible input voltage of the CBN400.1 Isolating Measurement Probe on the application altitude!**

The maximum permissible input voltage of the CBN400.1 Isolating Measurement Probe depends on its application altitude above MSL!

Property	Description
Number of channels	4
Measuring range	±840 V
Input voltage (max.)	±840 V (below 4,000 m AMSL) ±600 V (between 4,000 m and 5,000 m AMSL)
Insulation test voltage	±1,500 V DC (input against output)
Insulation voltage	±840 V DC (input against U <sub>batt</sub> -)
Transient resistance	±800 V/μs
Input impedance	12 MΩ
Input capacitance	4 pF (with straight cable with a length of 20 cm at 10 kHz)
Coupling capacitance	10 pF (input against output)
Max. measurement error (Isolating Measurement Probe and ES411.1 module)	±(0.4 V +  U <sub>in</sub>   * 0.15%) (at +25 °C) ±(2 V +  U <sub>in</sub>   * 0.4%) (at -40 °C to +75 °C)

### 3.4 Mechanical data

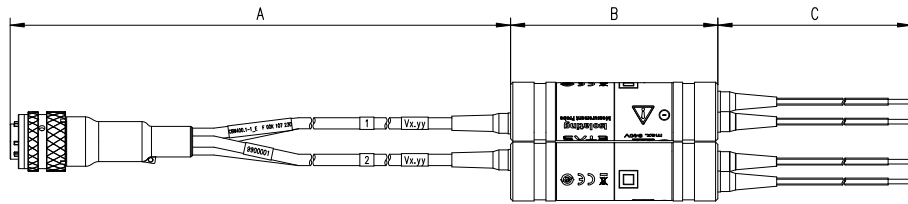

**Fig. 3-1** Dimensions

Dimensions (see Fig. 3-1)	A: 800 mm (stretched length; connection at ES411.1)
	B: 88 mm (diameter: 25 mm)
	C: 200 mm (high-voltage connection)
Weight	approx. 430 g

### 3.5 Mapping of measuring channels

The four identical active voltage measuring channels of the CBN400.1 Isolating Measurement Probe are identified with 1 to 4 on the splitter cable at the low-voltage side (see Fig. 2-2 on page 13). The mapping of the measuring channels of the Isolating Measurement Probe to the ES411.1 measuring channels is shown in the following table.

<b>CBN400.1 measuring channel</b>	<b>ES411.1 measuring channel</b>
1	1
2	2
3	3
4	4

This channel mapping is used in the application software.

## 4 **Ordering Information**

---

<b>Order name</b>	<b>Short name</b>	<b>Order number</b>
CBN400.1 Isolating Measurement Probe, 840 V Isolation, 4 Channels, 840 V Range, Souriau 8ST12- 35 4xOpen Wires (22mc 4x2c), 4 x 1 m	CBN400.1-1	F 00K 107 227

---

### **Scope of supply**

---

CBN400.1 Isolating Measurement Probe (840 V), ETAS Safety Advice, China-RoHS-leaflet\_Compact\_green\_cn, Calibration-Certification, CDROM ES4xx\_DRV\_SW\_CD (driver and tools for ES4xx)

---





## 5 **ETAS Contact Addresses**

---

### *ETAS HQ*

---

ETAS GmbH

Borsigstraße 14

70469 Stuttgart

Germany

Phone: +49 711 3423-0

Fax: +49 711 3423-2106

WWW: [www.etas.com](http://www.etas.com)

### *ETAS Subsidiaries and Technical Support*

---

For details of your local sales office as well as your local technical support team and product hotlines, take a look at the ETAS website:

ETAS subsidiaries WWW: [www.etas.com/en/contact.php](http://www.etas.com/en/contact.php)

ETAS technical support WWW: [www.etas.com/en/hotlines.php](http://www.etas.com/en/hotlines.php)



---

## Figures

<b>Fig. 1-1</b>	WEEE symbol.....	9
<b>Fig. 2-1</b>	CBN400.1 with ES411.1 A/D module.....	11
<b>Fig. 2-2</b>	Design of the Isolating Measurement Probe .....	13
<b>Fig. 2-3</b>	Use of the CBN400.1 and the CBN401.1 in the high-voltage on-board system 16	
<b>Fig. 3-1</b>	Dimensions.....	22



---

## Index

### A

Accident prevention 6  
Ambient temperature 18  
Application software 20  
Applications 16

### C

Cable identification 15  
CE Declaration of Conformity 8  
Channel mapping, application software 22  
Charge state 16  
Cleaning 7  
Configuration instructions 20  
Customer service 15

### D

Damage, mechanical 14  
Data  
    mechanical 22  
    Technical 17  
Documentation 5  
Drive battery 16

### E

Electrical data 21  
Electrical isolation 11  
Electrical safety 6  
ES411.1 A/D module 11  
ETAS Contact Addresses 25

ETAS measuring system 11

### F

Firmware 19, 20

### H

Hardware version, compatible 19  
Hardware version, label 19  
Hardware, system requirements 19  
High-voltage on-board system 11, 16  
Housing 13

### I

Identification 13

### L

Low-voltage side 14

### M

Measuring accuracy, maintaining the 21  
Measuring channels 13  
Measuring channels, mapping of 22  
Mechanical data 22

### O

Occupational safety 6  
Operating voltage 14  
Operation  
    Conventions 10

Operation, requirements for 6  
Organization 9

**P**

Potential isolation 13  
Power supply 18  
Product return 8  
Properties 12

**Q**

Qualification, required 6  
Qualified electricians for high-voltage  
systems 5

**R**

Recycling 8  
RoHS conformity  
China 9  
European Union 9

**S**

Safety at work 6  
Safety instructions, basic 5  
Safety instructions, labeling 5  
Safety precautions 5  
Scope of supplies 10  
Serial number 15  
Signal conditioning 13  
Signal conditioning cable 11  
Souriau plug 13  
Splitter cable 13  
Standards and guidelines 17  
System requirements 19

**T**

Technical data 17  
Test lab, accredited 12, 18  
Type check, information about the 18

**U**

Use, correct 6

**V**

Voltage reduction 13

**W**

Waste Electrical and Electronic Equip-  
ment - WEEE 8  
WEEE return system 9