



**CBN100.1/ CBN102.1/ CBN104.1/  
CBN106.1**

**Isolating Measurement Probe**

User's Guide

## Copyright

---

The data in this document may not be altered or amended without special notification from ETAS GmbH. ETAS GmbH undertakes no further obligation in relation to this document. The software described in it can only be used if the customer is in possession of a general license agreement or single license. Using and copying is only allowed in concurrence with the specifications stipulated in the contract.

Under no circumstances may any part of this document be copied, reproduced, transmitted, stored in a retrieval system or translated into another language without the express written permission of ETAS GmbH.

© **Copyright 2020** ETAS GmbH, Stuttgart

The names and designations used in this document are trademarks or brands belonging to the respective owners.

CBN100.1/CBN102.1/CBN104.1/CBN106.1 - User's Guide R05 EN - 04.2020

# Contents

---

<b>1</b>	<b>About this Document</b> .....	<b>5</b>
1.1	Classification of Safety Messages .....	5
1.2	Presentation of Instructions .....	5
1.3	Typographical Conventions .....	6
1.4	Presentation of Supporting Information .....	6
<b>2</b>	<b>General</b> .....	<b>7</b>
2.1	Safety Instructions .....	7
2.1.1	General safety information .....	7
2.1.2	Requirements for users and duties for operators .....	7
2.1.3	Correct Use .....	7
2.2	Identifications on the product .....	9
2.3	CE marking .....	9
2.4	Product return and recycling .....	10
2.5	RoHS conformity .....	10
2.6	Scope of supplies .....	10
<b>3</b>	<b>Hardware description</b> .....	<b>11</b>
3.1	Overview .....	11
3.1.1	Combined use with measuring modules .....	11
3.1.2	Product variants .....	11
3.1.3	Properties .....	12
3.2	Assemblies and function .....	13
3.2.1	Design of the Isolating Measurement Probe .....	13
3.2.2	Measuring channel .....	14
3.2.3	Housing of measuring channel .....	14
3.2.4	Connections and cabling .....	15
3.2.5	Operating voltage .....	15
3.2.6	Serial number .....	15
3.3	Notes about commissioning .....	16
3.3.1	Use of the Isolating Measurement Probe CBN100.1/ CBN102.1/ CBN104.1/ CBN106.1 .....	16
3.3.2	Expanded functions when using the TEDS information of the Isolating Measurement Probes CBN100.1 and CBN106.1 .....	17
3.4	Applications .....	18
<b>4</b>	<b>Technical data</b> .....	<b>19</b>
4.1	General data .....	19
4.1.1	Standards and guidelines met .....	19
4.1.2	Type check .....	20
4.1.3	Application .....	20
4.1.4	Ambient conditions .....	20
4.2	Power supply .....	20
4.3	Electrical data .....	21
4.4	Mechanical data .....	22
4.5	Pin Assignment .....	23

4.5.1	High-voltage side (CBN100.1/ CBN102.1/ CBN104.1/ CBN106.1) . . . .	23
4.5.2	Low-voltage side . . . . .	23
<b>5</b>	<b>Ordering Information . . . . .</b>	<b>26</b>
5.1	Isolating Measurement Probe . . . . .	26
5.1.1	CBN100.1 . . . . .	26
5.1.2	CBN102.1 . . . . .	26
5.1.3	CBN104.1 . . . . .	26
5.1.4	CBN106.1 . . . . .	27
5.2	Calibration Service . . . . .	27
<b>6</b>	<b>Contact Information . . . . .</b>	<b>28</b>
	<b>Figures . . . . .</b>	<b>29</b>
	<b>Index . . . . .</b>	<b>30</b>

# 1 About this Document

---

## 1.1 Classification of Safety Messages

---

The safety messages used here warn of dangers that can lead to personal injury or damage to property:



### **DANGER**

---

indicates a hazardous situation with a high risk of death or serious injury if not avoided



### **WARNING**

---

indicates a hazardous situation of medium risk which could result in death or serious injury if not avoided.



### **CAUTION**

---

indicates a hazardous situation of low risk which may result in minor or moderate injury if not avoided.

### **NOTICE**

---

indicates a situation which may result in damage to property if not avoided.

## 1.2 Presentation of Instructions

---

The target to be achieved is defined in the heading. The necessary steps for his are in a step-by-step guide:

#### Target definition

1. Step 1
2. Step 2
3. Step 3
- > Result

## 1.3 Typographical Conventions

### Hardware

<b>Bold</b>	Menu commands, buttons, labels of the product
<i>Italic</i>	Emphasis on content and newly introduced terms

## 1.4 Presentation of Supporting Information

 **NOTE**

Contains additional supporting information.

## 2 General

---

The introductory chapter informs you about the basic safety information, product return and recycling, the use of this manual, the scope of delivery and other information.

### 2.1 Safety Instructions

---

#### 2.1.1 General safety information

Please observe the product safety advice ("ETAS Safety Advice CBN" and the subsequent safety instructions to avoid any impact on your health or damages to the device.

 **NOTE**

---

Carefully read the documentation that belongs to the product (ETAS Safety Advice CBN and this User's Guide) prior to the startup.

ETAS GmbH does not assume any liability for damages resulting from improper handling, unintended use or non-observance of the safety precautions.

#### 2.1.2 Requirements for users and duties for operators

The Isolating Measurement Probe product may be commissioned and used only by qualified electricians for high-voltage systems (BGI/GUV-I 8686 of the DGUV, minimum Level 2).

The product may be assembled, operated and maintained only if you have the necessary qualification and experience for this product. Improper use or use by a user without sufficient qualification can lead to damages or injuries to one's health or damages to property.

##### General safety at work

The existing regulations for safety at work and accident prevention must be followed.

#### 2.1.3 Correct Use

This product has been developed and released for use in automotive applications. For usage in other domains please contact your ETAS representative.

##### Requirements for Operation

 **WARNING**

---

This is a class A product. In a domestic environment this product may cause radio interference in which case the user may be required to take adequate measures.

**WARNING**

Check before each use of the product in high-voltage systems its function by measuring a known extra-low voltage.

The following requirements are put in place for safe operation:

- The Isolating Measurement Probe product meets the requirements of protection class IP65. Observe the notes for the ambient conditions (see chapter 4.1.4 on page 20).
- Use the product only according to the specifications in the corresponding user's guide. For any other use, the product safety is not ensured.
- This product must not be used for measuring of mains supply circuits.
- Observe the regulations concerning electrical safety and the laws and regulations concerning occupational safety applicable at the application site!
- Observe the rules for working on equipment with dangerous voltages!
- Carefully attach the high-voltage measuring cables.
- Keep the high-voltage measuring lines short to minimize the risks of injuries from pinching, contracting, scoring or shearing.
- Do not use the product in a wet or humid environment.
- Do not use the product in a potentially explosive atmosphere.
- Keep the surfaces of the product clean and dry.

**Requirements for the technical State of the Product**

The product is designed in accordance with state-of-the-art technology and recognized safety rules. The product may be operated only in a technically flawless condition and according to the intended purpose and with regard to safety and dangers as stated in the respective product documentation. If the product is not used according to its intended purpose, the protection of the product may be impaired.

**DANGER**

**Risk of electric shock with damaged housing of a measuring channel or damaged insulation of a high-voltage cable!**

Electric shock upon touching energized components of the Isolating Measurement Probe leads to injuries, heart failure or death.

A damaged Isolating Measurement Probe must be decommissioned **immediately!**

**Ensure that the damaged Isolating Measurement Probe is not longer being used!**

A repair of the Isolating Measurement Probe is not possible, attempts to repair are not permissible!









## Maintenance and cleaning

The product is maintenance-free. For cleaning, use a clean and dry cloth.

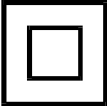
## 2.2 Identifications on the product

The high-voltage side of the housings of the measuring channels of the CBN100.1/ CBN102.1/ CBN104.1/ CBN106.1 Isolating Measurement Probe is identified in orange. The following symbols are used for identifying the product:

Symbol	Description
	Before using the product, carefully read the user's guide!
840 V	Maximum input voltage 840 V
	Measuring input, minus
	Measuring input, plus
	Housing protected with double insulation (acc. to EN 61010-1)
	Identification for CE, see chapter 2.3 on page 9
	Identification for RoHS, see chapter on page 10
	Identification for China RoHS, see chapter on page 10

Observe the information in chapter "Technical data" on page 19.

## 2.3 CE marking

ETAS confirms that the product meets the product-specific applicable European Directives with the CE marking affixed to the product or its packaging. The CE Declaration of Conformity for the product is available upon request.

## 2.4 Product return and recycling

---

The European Union (EU) issued the Waste Electrical and Electronic Equipment (WEEE) Directive to ensure the setup of systems for collecting, handling and processing electronic waste in all countries of the EU.

This ensures that the equipment is recycled in a resource-saving manner that does not represent any risk for the health and safety of humans and the environment.



**Fig. 2-1** WEEE symbol

The WEEE symbol (see Fig. 2-1 on page 10) on the product or its packaging identifies that the product may not be disposed of together with garbage.

The user is obligated to collect used equipment separately and provide them to the WEEE return system for recycling.

The WEEE directive relates to all ETAS equipment, but not to external cables or batteries.

Additional information about the recycling program of ETAS GmbH can be obtained from the ETAS sales and service branch offices (see chapter 6 on page 28).

## 2.5 RoHS conformity

---

### European Union

The EU Directive 2002/95/EU limits the use of certain dangerous materials for electrical and electronic devices (RoHS conformity).

ETAS confirms that the product corresponds to this directive which is applicable in the European Union.

### China

ETAS confirms that the product meets the product-specific applicable guidelines of the China RoHS (Management Methods for Controlling Pollution Caused by Electronic Information Products Regulation) applicable in China with the China RoHS marking affixed to the product or its packaging.

## 2.6 Scope of supplies

---

Before the initial startup of your CBN100.1/ CBN102.1/ CBN104.1/ CBN106.1 Isolating Measurement Probe, please verify that the device has been delivered with all the required parts (see the chapter "Ordering Information" on page 26).

## 3 Hardware description

This chapter provides an overview of the Isolating Measurement Probe CBN100.1/ CBN102.1/ CBN104.1/ CBN106.1 and information about housing, serial number and connections.

### 3.1 Overview

#### 3.1.1 Combined use with measuring modules

The Isolating Measurement Probe CBN100.1/ CBN102.1/ CBN104.1/ CBN106.1 is a signal conditioning cable with an active voltage measuring channel integrated in the cable for the combined use with A/D modules from external providers.

The combination of the measurement modules with the Isolating Measurement Probe expands their application range by the potential-free measurement of voltages up to 840 V, e.g. in the high-voltage electrical system of hybrid and electric vehicle systems. The electrical isolation between the voltage in the high-voltage electrical system and the measurement module occurs close to the measuring point in the measuring channel of the isolating measurement probe.

The Isolating Measurement Probe CBN100.1/ CBN102.1/ CBN104.1/ CBN106.1 provides an efficient solution for measuring voltages during the development, application and validation of ECUs of the electric drive.

#### 3.1.2 Product variants

The Isolating Measurement Probe CBN100.1/ CBN102.1/ CBN104.1/ CBN106.1 was developed for these applications and is available in four different assembled variants:

Isolating Measurement Probe	Connection to measurement module	
	Assembly	Application example
CBN100.1	Open Wire	Adaptation to measurement setup by the user
CBN102.1	Lemo FGA.0B.306	with A/D module CSM ADMM 4/ 8 classic/ pro
CBN104.1	Lemo FGG.1B.306	with A/D module IPETRONIK M-SENSE 4
CBN106.1	Lemo FGG.1B.310	with A/D module Softing MA08.1

#### NOTE

The complete technical data of the Isolating Measurement Probe CBN100.1/ CBN102.1/ CBN104.1/ CBN106.1 is located in the chapter "Technical data" on page 19.

**i NOTE**

Unless otherwise indicated, the descriptions, properties and technical data in this manual apply to all variants of the Isolating Measurement Probe (CBN100.1, CBN102.1, CBN104.1 and CBN106.1).

In these text segments, the common short name "CBN100.1/ CBN102.1/ CBN104.1/ CBN106.1" is being used.

**i NOTE**

Except for the assembly of the connectors at the low-voltage side, the four variants of the Isolating Measurement Probe feature an identical electrical and mechanical design.

### 3.1.3 Properties

The most important properties of the Isolating Measurement Probe CBN100.1/ CBN102.1/ CBN104.1/ CBN106.1:

- Use in combination with A/D modules from external providers
- Compact isolating measurement probes for measuring voltages in high-voltage electrical systems of hybrid or electric vehicles
- High level of safety through electrical isolation near the measuring point
- Electrical isolation for up to 840 V potential difference
- 840 V measurement range for acquiring on-board system voltages
- Suitable for measurements directly at the inverter and the electric machine
- Voltage supply integrated in the measuring cable
- Automatic functions possible for procedures in accordance with TEDS standard (Isolating Measurement Probes CBN100.1 and CBN106.1 only)
- Automotive-capable product that is suitable for use in the development environment and in the vehicle on test courses.
  - Immune to ambient conditions (temperature, EMC)
  - High level of mechanical stability and robustness
- Product safety through type inspection and certification by accredited test lab

The complete technical data of the CBN100.1/ CBN102.1/ CBN104.1/ CBN106.1 is located in the chapter "Technical data" on page 19.

## 3.2 Assemblies and function

### 3.2.1 Design of the Isolating Measurement Probe

**i NOTE**

Except for the assembly of the connectors at the low-voltage side, the four variants of the Isolating Measurement Probe feature an identical electrical and mechanical design.

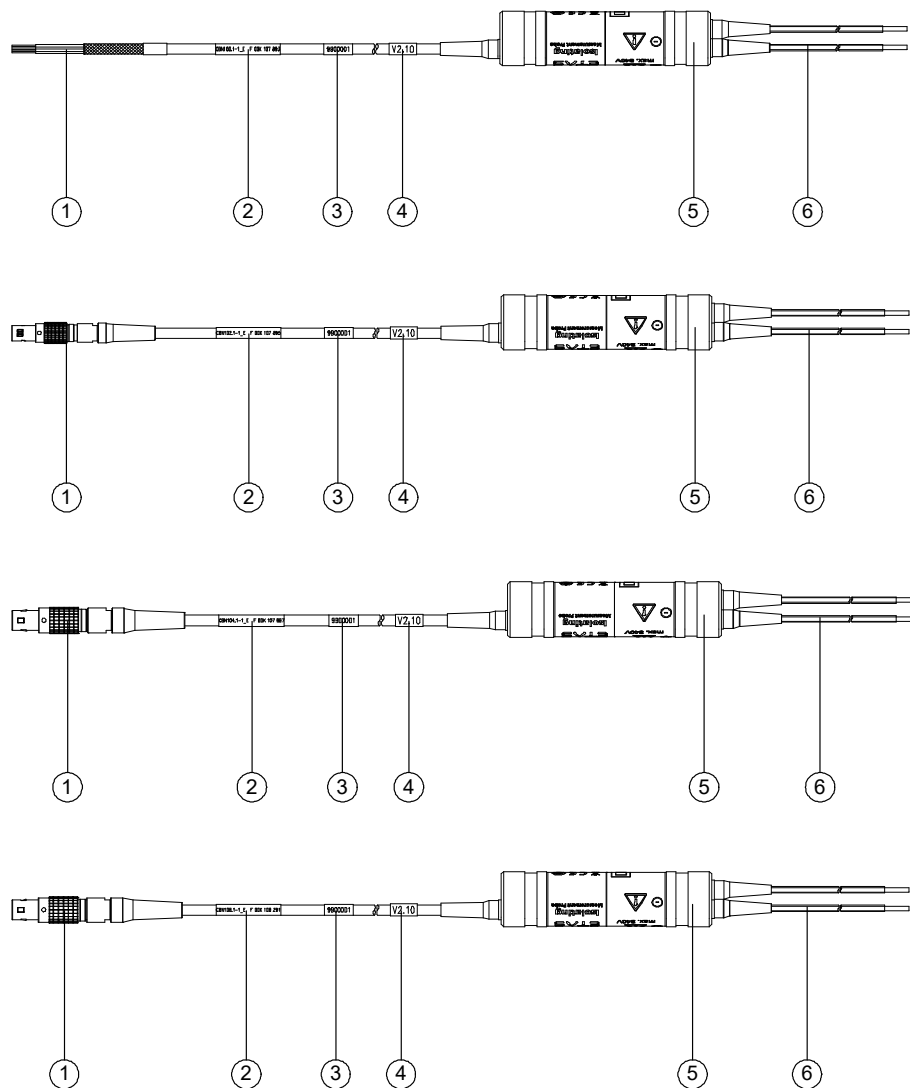

**Fig. 3-1** Design of the Isolating Measurement Probe CBN100.1/ CBN102.1/ CBN104.1/ CBN106.1 (top down)

No. in Fig. 3-1	Designation
1	Connection to the measurement module (low-voltage side): Open Wire (CBN100.1), Lemo FGA.0B.306 (CBN102.1), Lemo FGG.1B.306 (CBN104.1) and Lemo FGG.1B.310 (CBN106.1)
2	Short name and type-part number of product
3	Serial number of product
4	Hardware version number of product
5	Housing of measuring channel
6	Measuring leads (high-voltage side)

### 3.2.2 Measuring channel

The measuring channel is encased in an isolating cylindrical housing that contains the electronics and the electrical isolation of the measuring channel (see Fig. 3-1 on page 13).

Inside the housing of the measuring channel, the signal conditioning, voltage reduction and electrical isolation of the high-voltage signals from the low-voltage side.

### 3.2.3 Housing of measuring channel

#### Identification of the high-voltage side

The high-voltage side of the measuring channel housing is marked in orange.

#### Mechanical damage of the housing

In case of mechanical damage of the outside blue layer of the measuring channel housing, the underlying black sealing compound in this area is visible.



#### **DANGER**

**Danger of an electric shock  
with damaged housing of the measuring channel or  
with damaged insulation of high-voltage cable!**

Electric shock upon contact with energized components of the isolating measurement probe leads to injuries, heart failure or death.

A damaged Isolating Measurement Probe must be taken out of operation **immediately!**

**Ensure that the damaged Isolating Measurement Probe is not used any more!**

A repair of the isolating measurement probe is not possible, any repair attempts are not allowed!

## 3.2.4 Connections and cabling

### Low-voltage side

The low-voltage side of the isolating measurement probe is connected to an A/D module and is assembled differently depending on the design:

- Open Wire (CBN100.1),
- Lemo FGA.0B.306 (CBN102.1),
- Lemo FGG.1B.306 (CBN104.1) and
- Lemo FGG.1B.310 (CBN106.1)

### High-voltage side

The leads on the high-voltage side are marked in red/orange (input "+") and black/orange input "-").

To minimize dangers from long cables on the high-voltage side, short cable ends are used as connections to the housings of the measuring channels. This allows implementing longer connections in the measurement setup on the electrically isolated low-voltage side.

For the contacting in the measurement setup, the user can shorten or assemble the measuring channels on the high-voltage side upon demand (part 6 in Fig. 3-1 on page 13). The most compact design in the high-voltage range allows a high level of operational safety.

#### NOTE

Observe the regulations and rules for working on high-voltage systems in this context.

## 3.2.5 Operating voltage

The Isolating Measurement Probe requires a direct-current voltage as power supply which can be provided by an external power supply or the A/D module used. For this application, the output voltage of the A/D module (sensor supply voltage of the module) is used as power supply of the Isolating Measurement Probe.

## 3.2.6 Serial number

The serial number is located on the low-voltage side of the Isolating Measurement Probe CBN100.1/ CBN102.1/ CBN104.1/ CBN106.1 (no. 3 in Fig. 3-1 on page 13). It is required when you contact the technical customer service of ETAS.

### 3.3 Notes about commissioning

#### 3.3.1 Use of the Isolating Measurement Probe CBN100.1/ CBN102.1/ CBN104.1/ CBN106.1

If the Isolating Measurement Probe is operated in combination with an A/D module, the following settings are required:

- The output voltage of the A/D module (sensor supply voltage of the module) or the voltage that is used as the power supply of the Isolating Measurement Probe, must be manually set to 12 V. The following screenshot shows this setting when INCA is used as application software:

Channels   Sensor Supply   TEDS Information			
No.	Name	Output Voltage Selection	Output Voltage [V] GUI
1	Phase1	predefined	12.00

- Adjustment and calibration values for the combination of Isolating Measurement Probe and A/D module must be manually entered by the user in the application software for every Isolating Measurement Probe.

ETAS provides these values in a calibration certificate for every Isolating Measurement Probe. In the supplied calibration certificate, which is uniquely assigned to each unit of the measurement probe via the serial number, the following adjustment and calibration values can be found:

- Actual output voltage +10 V at input voltage of 840.455 V
- Actual output voltage -10 V at input voltage of -840.275 V

The following screenshot shows this setting of the sample values when using INCA as application software:

Channels   Sensor Supply											
No.	Sel.	Name	Units	Rate	AA-Filter	Digital Filter	Filter Frequency	Phys bottom	Phys top	Sensor bottom [v]	Sensor top [v]
1	<input checked="" type="checkbox"/>	ES411_ADS1_CH1	V	0.1ms	On	On	FIR auto	-840.28	840.46	-10.00	10.00

- The measuring range required for the Isolating Measurement Probe must be set manually.

**i NOTE**

The adjustment and calibration values used here are sample values. The values for your measurement probe variant can be found in the supplied calibration certificate of the measurement probe.



### 3.3.2 Expanded functions when using the TEDS information of the Isolating Measurement Probes CBN100.1 and CBN106.1

The following information is implemented in the TEDS of the measuring channel of the Isolating Measurement Probes CBN100.1 and CBN106.1:

- Magnitude of operating voltage of the Isolating Measurement Probe CBN100.1/CBN106.1,
- Adjustment and calibration values of the Isolating Measurement Probe CBN100.1/CBN106.1,
- Information about the required measuring range.

If the Isolating Measurement Probe CBN100.1 or the Isolating Measurement Probe CBN106.1 is operated with a customer-specific application software that uses procedures in accordance with TEDS standard and if the application software is adjusted accordingly, the following automatic functions can be implemented:

- automatic setup of the power supply of the Isolating Measurement Probe by the supplying A/D module,
- automatic transfer of the individual adjustment and calibration values for the combination consisting of Isolating Measurement Probe and A/D module,
- automatic setup of measuring range for the Isolating Measurement Probe in the customer-specific application software.

### 3.4 Applications

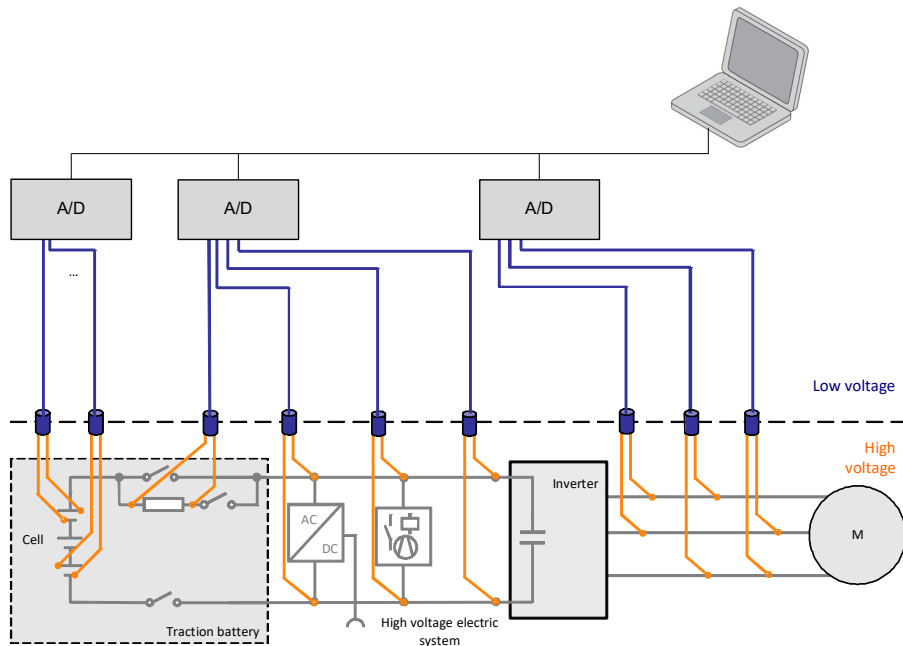

**Fig. 3-2** Use of the Isolating Measurement Probe

Typical applications are the monitoring of voltages in the high-voltage electrical system, e.g. at the drive battery, at individual cells of the drive battery or at DC links (see Fig. 3-2 on page 18). With the help of the voltage measurements, it is possible, for example, to measure the charge state of the drive battery, the behavior of the battery under load, fluctuations in the high-voltage electrical system or the targeted discharge of the battery in safety-critical situations independent of the ECU.

## 4 Technical data

This chapter describes the standards and guidelines that have been met, the ambient conditions, mechanical data, system requirements for operating the Isolating Measurement Probe and the electrical data.

### NOTE

Except for the assembly of the connectors at the low-voltage side, the four variants of the Isolating Measurement Probe feature an identical electrical and mechanical design.

### 4.1 General data

#### NOTE

The power supply used for the CBN100.1/ CBN102.1/ CBN104.1/ CBN106.1 Isolating Measurement Probe must be permanent protected against over-load and short circuit.

#### 4.1.1 Standards and guidelines met

The Isolating Measurement Probe CBN100.1/ CBN102.1/ CBN104.1/ CBN106.1 corresponds to the following standards and guidelines:

Standard	Test
EN 61010-1	Safety regulations for electrical measurement, control and laboratory use
EN 61326	Electrical equipment for measurement, control and laboratory use - EMC requirements
EN 61000-6-2	Interference immunity (industrial environment) <sup>1)</sup>
EN 61000-6-4	Interference emission (industrial environments)

<sup>1)</sup>: The module must be supplied by a DC power supply or a battery with operating voltage. Between module and voltage source, cables with a maximum length of 30 m are allowed.

The Isolating Measurement Probe CBN100.1/ CBN102.1/ CBN104.1/ CBN106.1 is designed only for use in industrial environments in accordance with EN 61000-6-4. When using the module outside of industrial environments avoid possible radio disturbances by additional shielding measures!



### WARNING

This is a class A product. In a domestic environment this product may cause radio interference in which case the user may be required to take adequate measures.

### 4.1.2 Type check

The CBN100.1/ CBN102.1/ CBN104.1/ CBN106.1 Isolating Measurement Probe was checked by an accredited test lab with respect to type and certified. Information about the type check of the product are available from ETAS upon request.

### 4.1.3 Application



#### WARNING

Check before each use of the product in high-voltage systems its function by measuring a known extra-low voltage.



#### WARNING

**Dependency of the maximum permissible input voltage of the CBN100.1/ CBN102.1/ CBN104.1/ CBN106.1 Isolating Measurement Probe on the application altitude!**

The maximum permissible input voltage of the CBN100.1/ CBN102.1/ CBN104.1/ CBN106.1 Isolating Measurement Probe depends on its application altitude above MSL (see chapter 4.3 on page 21)!

### 4.1.4 Ambient conditions

Operating temperature range	-40 °C to +75 °C -40 °F to +167 °F
Altitude	max. 5,000 m / 16,400 ft
Relative humidity (non-condensing)	0 to 95%
Protection class	IP65

## 4.2 Power supply

#### NOTE

The power supply used for the CBN100.1/ CBN102.1/ CBN104.1/ CBN106.1 Isolating Measurement Probe must be permanent protected against overload and short circuit.

	Min.	Typ.	Max.	Unit
Supply voltage	11.5	12.0	12.5	V DC
Current consumption (at 12 V)	+25 °C	15		mA
	-40 °C to +75 °C		20	mA

### 4.3 Electrical data

#### NOTE

Unless specified otherwise, all data apply at 25 °C.



#### WARNING

**Dependency of the maximum permissible input voltage of the CBN100.1/ CBN102.1/ CBN104.1/ CBN106.1 Isolating Measurement Probe on the application altitude!**

The maximum permissible input voltage of the CBN100.1/ CBN102.1/ CBN104.1/ CBN106.1 Isolating Measurement Probe depends on its application altitude above MSL!

Property	Description
Number of channels	1
Measuring range	±840 V
Input voltage (max.)	±840 V (below 4,000 m AMSL)
	±600 V (between 4,000 m and 5,000 m AMSL)
Insulation test voltage	±1,500 V DC (input against output)
Insulation voltage	±840 V DC (input against Ubatt-)
Transient overvoltage	2,500 V
Transient resistance	±800 V/μs
Input impedance	12 MΩ
Input capacitance	4 pF (with straight cable with a length of 20 cm at 10 kHz)
Coupling capacitance	10 pF (input against output)
Max. measurement error	±(0.1 V +  U <sub>in</sub>   * 0.02%) (at +25 °C)
	±(0.4 V +  U <sub>in</sub>   * 0.1%) (at -40 °C to +75 °C)

#### NOTE

ETAS guarantees that the measuring accuracy of the CBN100.1/ CBN102.1/ CBN104.1/ CBN106.1 Isolating Measurement Probe is maintained for one year.

### Frequency Response

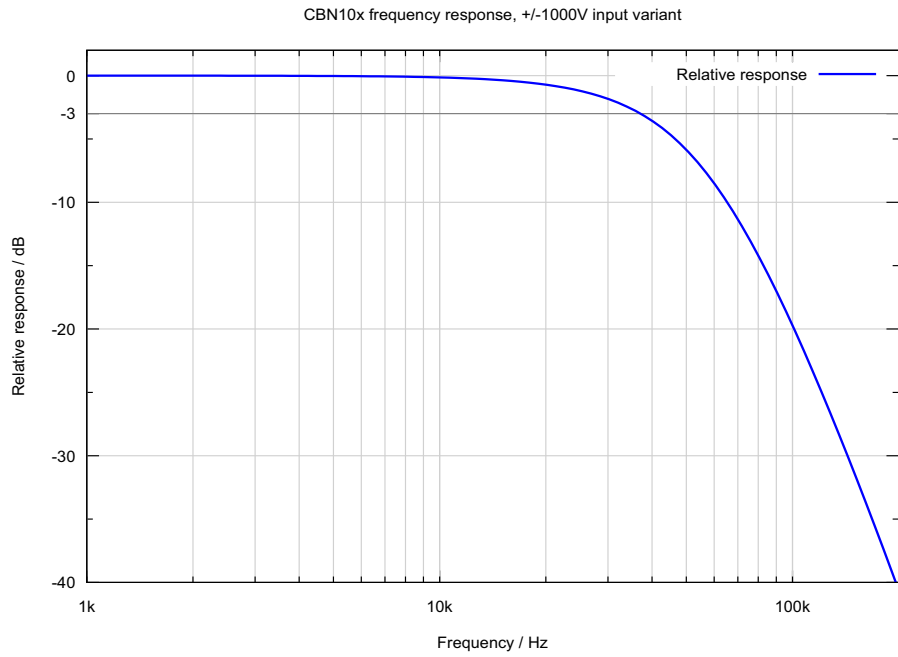

Fig. 4-1 Isolating Measurement Probe Frequency Response

## 4.4 Mechanical data

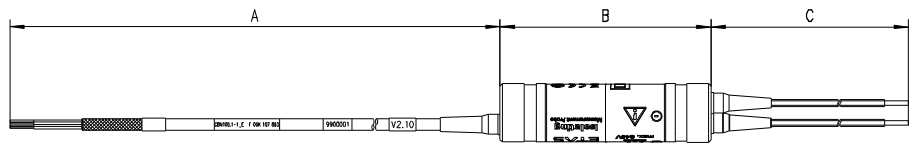

Fig. 4-2 Dimensions CBN100.1

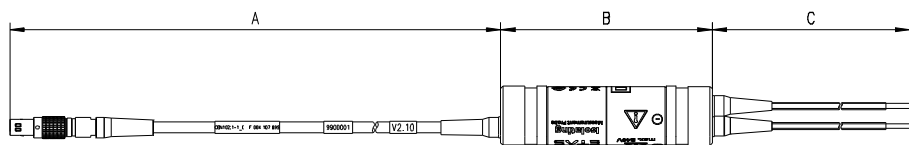

Fig. 4-3 Dimensions CBN102.1

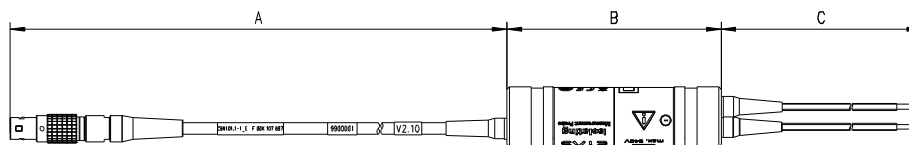
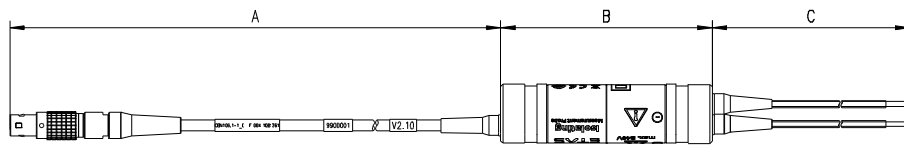

Fig. 4-4 Dimensions CBN104.1



**Fig. 4-5** Dimensions CBN106.1

Dimensions (see figures above)	A: 800 mm (stretched length; connection at A/D module)
	B: 88 mm (diameter: 25 mm)
	C: 200 mm (high-voltage connection)
Weight	approx. 105 g (without plug)

## 4.5 Pin Assignment

### 4.5.1 High-voltage side (CBN100.1/ CBN102.1/ CBN104.1/ CBN106.1)

Color	Signal	Description
red/orange	IN+	Input „+“
black/orange	IN-	Input „-“

### 4.5.2 Low-voltage side

#### CBN100.1 (Open wire)

Color	Signal	Description
Brown	Supply	Supply voltage, plus
Pink	Supply_GND	Supply voltage, ground
Green	Out+	Output voltage of the measurement probe, plus
Yellow	Out-	Output voltage of the measurement probe, minus
Gray	TEDS+	TEDS
White	TEDS-	TEDS, GND
		Cable shield

**CBN102.1 (Lemo plug)**

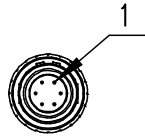

**Fig. 4-6** Lemo FGA.0B.306.CLA

Pin	Signal	Description
1	Out+	Output voltage of the measurement probe, plus
2	Out-	Output voltage of the measurement probe, minus
4	Supply	Supply voltage, plus
5	Supply_GND	Supply voltage, ground

**i NOTE**

Cable shield is connected with Lemo plug housing.

**CBN104.1 (Lemo plug)**

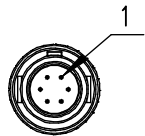

**Fig. 4-7** Lemo FGG.1B.306.CLA

Pin	Signal	Description
1	Out+	Output voltage of the measurement probe, plus
2	Out-	Output voltage of the measurement probe, minus
4	Supply	Supply voltage, plus
5	Supply_GND	Supply voltage, ground

**i NOTE**

Cable shield is connected with Lemo plug housing.



## CBN106.1 (Lemo plug)

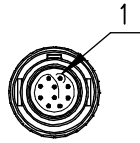

Fig. 4-8 Lemo FGG.1B.310.CLA

Pin	Signal	Description
1	Out-	Output voltage of the measurement probe, minus
2	N.C.	No connection
3	Supply_GND	Supply voltage, ground
4	Out+	Output voltage of the measurement probe, plus
5	N.C.	No connection
6	N.C.	No connection
8	TEDS-	TEDS, GND
9, Housing		Cable shield
10	TEDS+	TEDS

 **NOTE**

Cable shield is connected with Lemo plug housing.

## 5 Ordering Information

---

### 5.1 Isolating Measurement Probe

---

#### 5.1.1 CBN100.1

Order name	Short name	Order number
CBN100.1 Isolating Measurement Probe, 840 V Isolation, 1 Channel, 840 V Range, Open Wires - Open Wires (6c - 2c), 1 m	CBN100.1-1	F 00K 107 887
Scope of supply		
CBN100.1 Isolating Measurement Probe (840 V), Routine Test Certificate CBN1xx, ETAS Safety Advice, Calibration Certificate, China-RoHS-leaflet_Compact_green_cn, CDROM ES4xx_DRV_SW_CD (driver and tools for ES4xx)		

#### 5.1.2 CBN102.1

Order name	Short name	Order number
CBN102.1 Isolating Measurement Probe, 840 V Isolation, 1 Channel, 840 V Range, Lemo FGA.0B.306 - Open Wires (6m - 2c), 1 m	CBN102.1-1	F 00K 107 889
Scope of supply		
CBN102.1 Isolating Measurement Probe (840 V), Routine Test Certificate CBN1xx, ETAS Safety Advice, Calibration Certificate, China-RoHS-leaflet_Compact_green_cn, CDROM ES4xx_DRV_SW_CD (driver and tools for ES4xx)		

#### 5.1.3 CBN104.1

Order name	Short name	Order number
CBN104.1 Isolating Measurement Probe, 840 V Isolation, 1 Channel, 840 V Range, Lemo FGG.1B.306 - Open Wires (6m - 2c), 1 m	CBN104.1-1	F 00K 107 891
Scope of supply		
CBN104.1 Isolating Measurement Probe (840 V), Routine Test Certificate CBN1xx, ETAS Safety Advice, Calibration Certificate, China-RoHS-leaflet_Compact_green_cn, CDROM ES4xx_DRV_SW_CD (driver and tools for ES4xx)		

### 5.1.4 CBN106.1

Order name	Short name	Order number
CBN106.1 Isolating Measurement Probe, 840 V Isolation, 1 Channel, 840 V Range, Lemo FGG.1B.310 - Open Wires (6m - 2c), 1 m	CBN106.1-1	F 00K 108 260
Scope of supply		
CBN106.1 Isolating Measurement Probe (840 V), Routine Test Certificate CBN1xx, ETAS Safety Advice, Calibration Certificate, China-RoHS-leaflet_Compact_green_cn, CDROM ES4xx_DRV_SW_CD (driver and tools for ES4xx)		

### 5.2 Calibration Service

Order name	Short name	Order number
Calibration Service for CBN100.1/ CBN102.1/ CBN104.1/ CBN106.1	K_CBN1xx	F 00K 107 912

## 6 Contact Information

---

### ETAS Headquarters

ETAS GmbH

Borsigstraße 24  
70469 Stuttgart  
Germany

Phone: +49 711 3423-0  
Fax: +49 711 3423-2106  
Internet: [www.etas.com](http://www.etas.com)

### ETAS Subsidiaries and Technical Support

For details of your local sales office as well as your local technical support team and product hotlines, take a look at the ETAS website:

ETAS subsidiaries            Internet: [www.etas.com/en/contact.php](http://www.etas.com/en/contact.php)  
ETAS technical support    Internet: [www.etas.com/en/hotlines.php](http://www.etas.com/en/hotlines.php)

## Figures

---

Fig. 2-1	WEEE symbol .....	10
Fig. 3-1	Design of the Isolating Measurement Probe CBN100.1/ CBN102.1/ CBN104.1/ CBN106.1 (top down) .....	13
Fig. 3-2	Use of the Isolating Measurement Probe .....	18
Fig. 4-1	Isolating Measurement Probe Frequency Response .....	22
Fig. 4-2	Dimensions CBN100.1 .....	22
Fig. 4-3	Dimensions CBN102.1 .....	22
Fig. 4-4	Dimensions CBN104.1 .....	22
Fig. 4-5	Dimensions CBN106.1 .....	23
Fig. 4-6	Lemo FGA.0B.306.CLA .....	24
Fig. 4-7	Lemo FGG.1B.306.CLA .....	24
Fig. 4-8	Lemo FGG.1B.310.CLA .....	25

# Index

---

<b>A</b>	
Accident prevention	7
Ambient temperature	20
Applications	18
<b>C</b>	
Calibration Service	27
CBN100.1	26
CBN102.1	26
CBN104.1	26
CE Declaration of Conformity	9
Charge state	18
Cleaning	9
Commissioning	16
Customer service	15
<b>D</b>	
Damage, mechanical	14
Data	
mechanical	22
Technical	19
Documentation	7
Drive battery	18
<b>E</b>	
Electrical data	21
Electrical isolation	14
Electrical safety	8
<b>H</b>	
High-voltage electrical system	11, 18
High-voltage side	15
Housing	14
<b>I</b>	
Identification	14
Isolation, electrical	11
<b>L</b>	
Low-voltage side	15
<b>M</b>	
Measuring accuracy, maintaining the	21
Measuring channel	14
Mechanical data	22
<b>O</b>	
Occupational safety	8
Operating voltage	15
Operation, requirements for	7
<b>P</b>	
Power supply	20
Product return	10
Product variants	11
Properties	12
<b>Q</b>	
Qualification, required	7
Qualified electricians for high-voltage systems	7
<b>R</b>	
Recycling	10
RoHS conformity	
China	10
European Union	10
<b>S</b>	
Safety at work	7
Safety instructions, basic	7
Safety instructions, labeling	7
Safety precautions	7
Scope of supplies	10
Serial number	15
Settings	16
Signal conditioning	14
Signal conditioning cable	11
Standards and guidelines	19
<b>T</b>	
Technical data	19
TEDS	17
Test lab, accredited	12, 20
Type check, information about the	20
<b>U</b>	
Use, correct	7
<b>V</b>	
Voltage reduction	14
<b>W</b>	
Waste Electrical and Electronic Equipment	
- WEEE	10
WEEE return system	10