

INCA V7.5 – What's New

Changes / Extensions done in this Version

Overview

- 1. Product information**
(Use cases, Sample applications, Customer value)
 - Functionality
 - Standards
 - Usability
 - HW support
 - Add-ons
- 2. INCA Product Family**
- 3. Phase out information**
- 4. General Notes**

Functionality

INCA V7.5 – What's New

Functionality

HWC – Enhance the system mapping dialog

The mapping dialog will now only open automatically if there is at least one estimated connection and the HWC setup has changed since the last time.

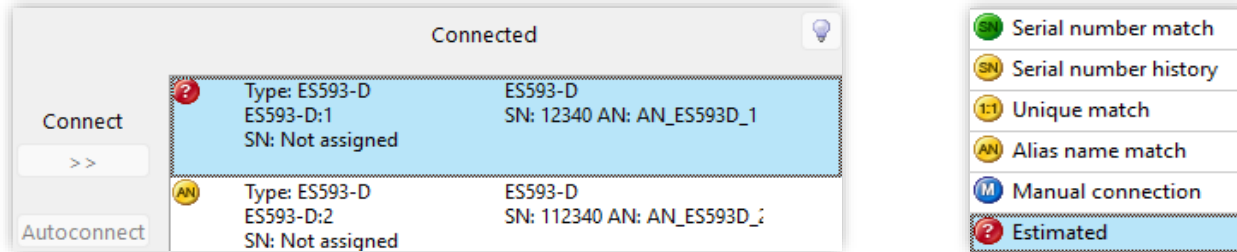

It's now possible to open the mapping dialog manually from the HWC and EE.

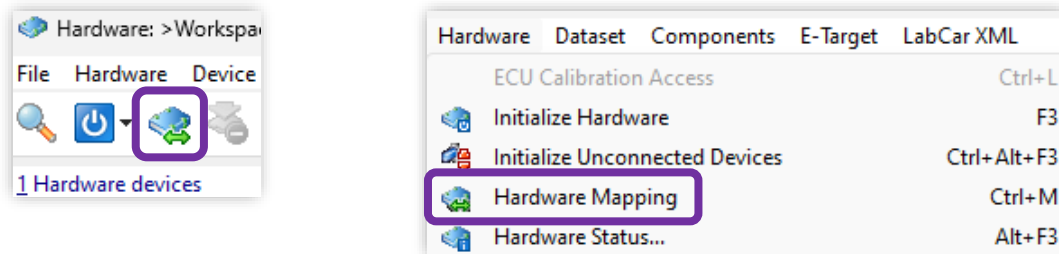

Functionality

MC-Gateway – Access to Micro Processor based Control Units

Measurement of internal variables of user-applications, running in an AUTOSAR adaptive environment on a Micro-Processor

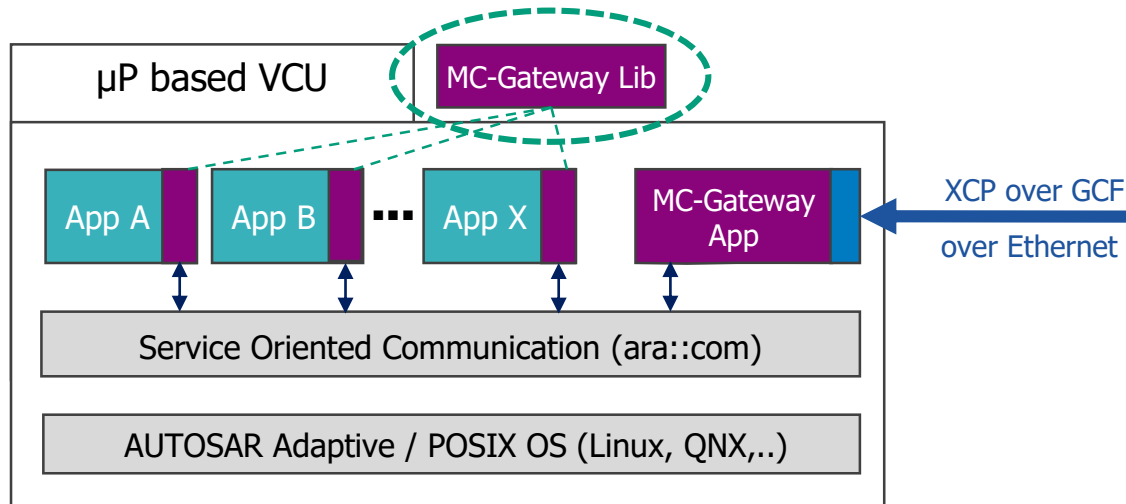

An **App** is like one μC based ECU. The **look and feel** of the MC Gateway is like normal **ETKs**

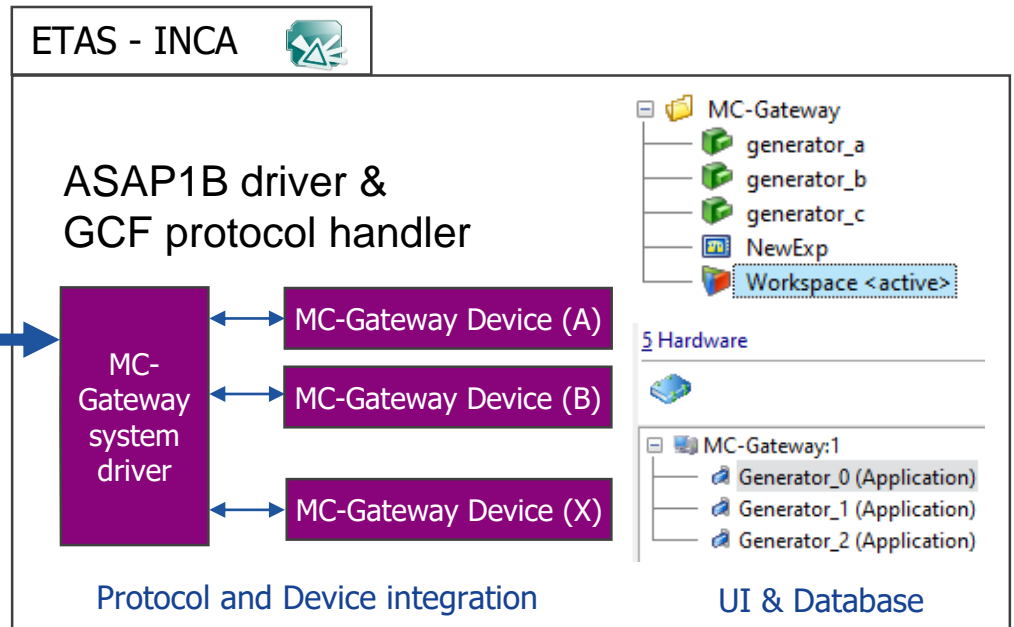

Available with INCA V7.5 SP3

Functionality

ETK – Multiple DAQs per raster

One DAQ list per raster, leads to max 255 ODTs * 252 entries = 64,260 signals / raster.

INCA supports now more than one DAQ list per raster, i.e. more than 64,260 signals / raster.

How many DAQ lists per raster are supported depends on the ETK type.

- FETKs support 2 DAQ lists per raster
- XETK-S10, S12, S14 support 2 DAQ lists per raster

INCA V7.5 – What's New

Functionality

ES134 – Integration in INCA – LIN to Ethernet

- Extends an ETAS hardware set up with 2 x LIN Channels
- Supports baud rates up to 20 kbit/sec
- FE coded Lemo connector for connection to ES8xx, ES5xx and ES600.2 devices
- Power and communication over the Ethernet Host cable
- Supports ETAS time synchronization mechanism
- Supports the ETAS wake up – sleep mechanism
- Firmware update possible using Hardware Service Pack (HSP)

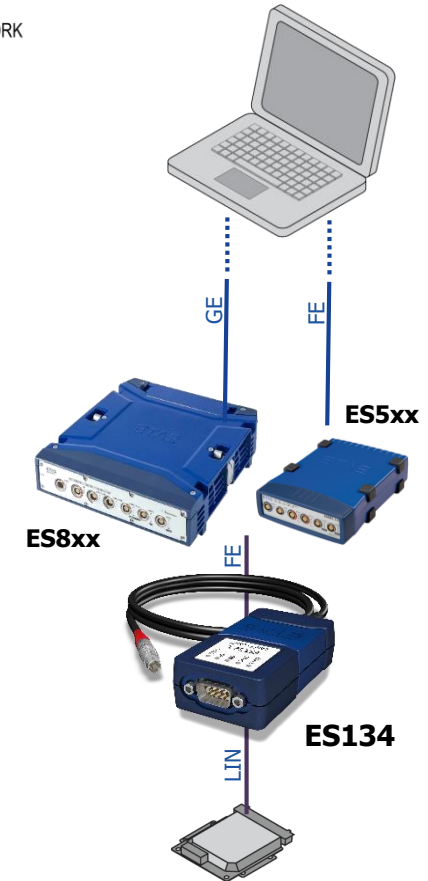

Available with INCA V7.5 SP3

INCA V7.5 – What's New

Functionality

Ethernet Network Mapping

- The configuration of the Ethernet Network is single source handled in the Web GUI of the Hardware (where the configuration is persisted), no more redundant configuration work
- INCA reads the configuration from the hardware and offers the INCA Alias as selection for the Network name
- Offline preparation as well as automated configuration via API supported
- Hint: no compatibility to existing workspaces

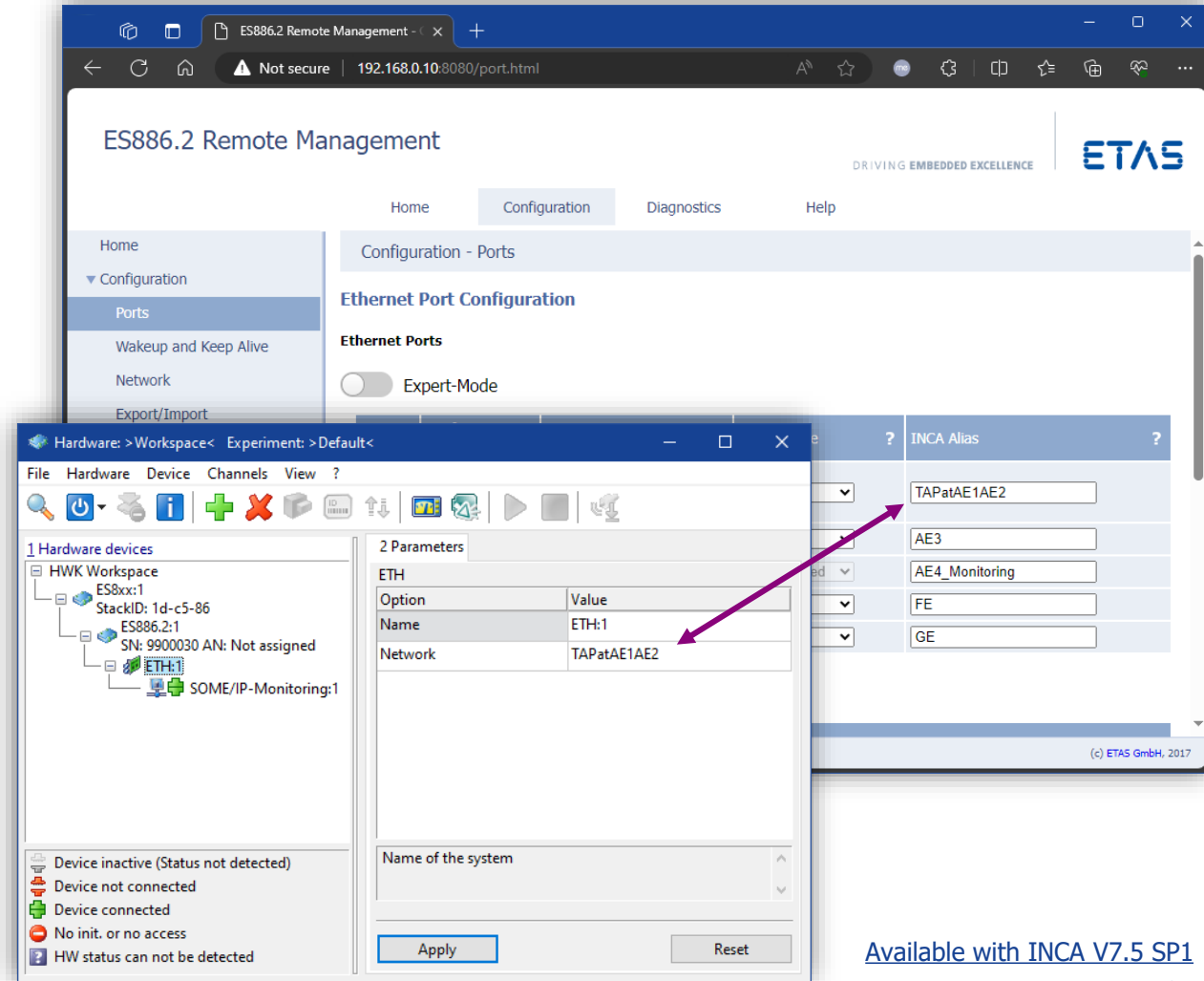

Available with INCA V7.5 SP1

ASAP2 TRANSFORMER - Support of 32bit DLL in 64bit INCA

The ASAM MCD2 MC standards defines transformer DLL for special conversion methods.

INCA as 64bit application requires 64bit DLLs.
To be compatible with 32bit DLLs INCA offers a DLL wrapper that allows 32bit DLLs too.

Transformer Processing

Data representation in MC Tool

- Physical
- Human readable

Data handling in MC Tool

- External conversion
- Adaption to ECU
 - Byte Order

Data in ECU representation

- Binary
- Processor specific

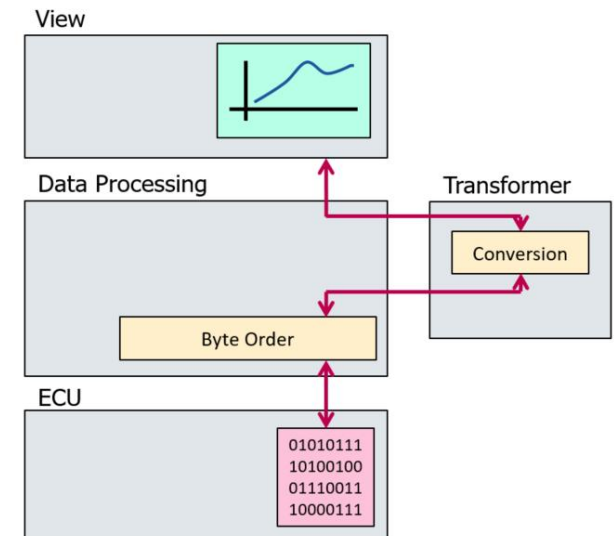



AUTOSAR – Support of TLV encoded SOME/IP data

- Supported for AUTOSAR CP R4.4
- Data elements of SOME/IP are organized in structures.
- With the **TLV** feature:
 - The elements of the structures have a header containing **T**ag and **L**ength information before the **V**alue.
 - This allows reordering or omitting of values.

→ Elements with TLV encoding are measured in own data groups.

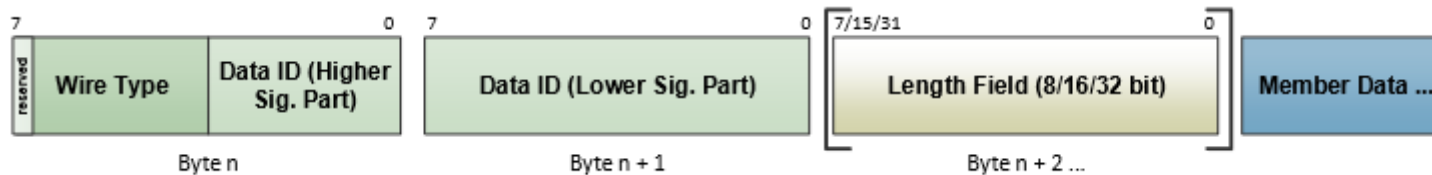



AUTOSAR – Monitoring of contained PDUs with not matching sizes

- Predecessor INCA versions allowed only to measure Contained PDUs (PDUs inside a Container PDU) with the same size on the Bus (blue frame) as defined in the description file (filled light blue).
- Newly supported
 - Size on Bus is larger (green frame)
 - Size on Bus is smaller (orange frame); in this case the Signal 7 is not allowed to be used and INCA will stop the acquisition of all signals from this PDU if the Signal 7 is used and print a message to the INCA Monitor informing the user about the first found not received signal





AUTOSAR – Allow switching between ISignal name and SystemSignal name

- AUTOSAR description files contain the ISignal name as well as the SystemSignal name for elements used as monitoring variables.
- INCA allows to switch between the two names to align to the tool environment for further processing for:
 - LIN-Monitoring
 - CAN-Monitoring
 - FLX-Monitoring
- Predecessor versions of INCA use in the above mentioned monitoring devices always the SystemSignal name.
- Hint: Since due to switched name experiment elements may become NoMatch signals, ETAS offers a Variable Name Converter as free Add-on, see Add-on section of the slide set.

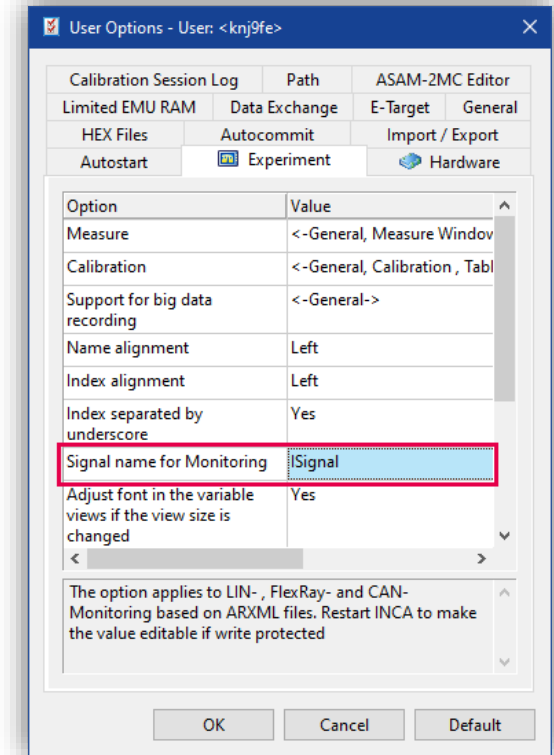

Available with INCA V7.5 SP1

Functionality

VSD – Device column at variables configuration grid

The new column "Data Source" allows to distinguish the variables from different devices.

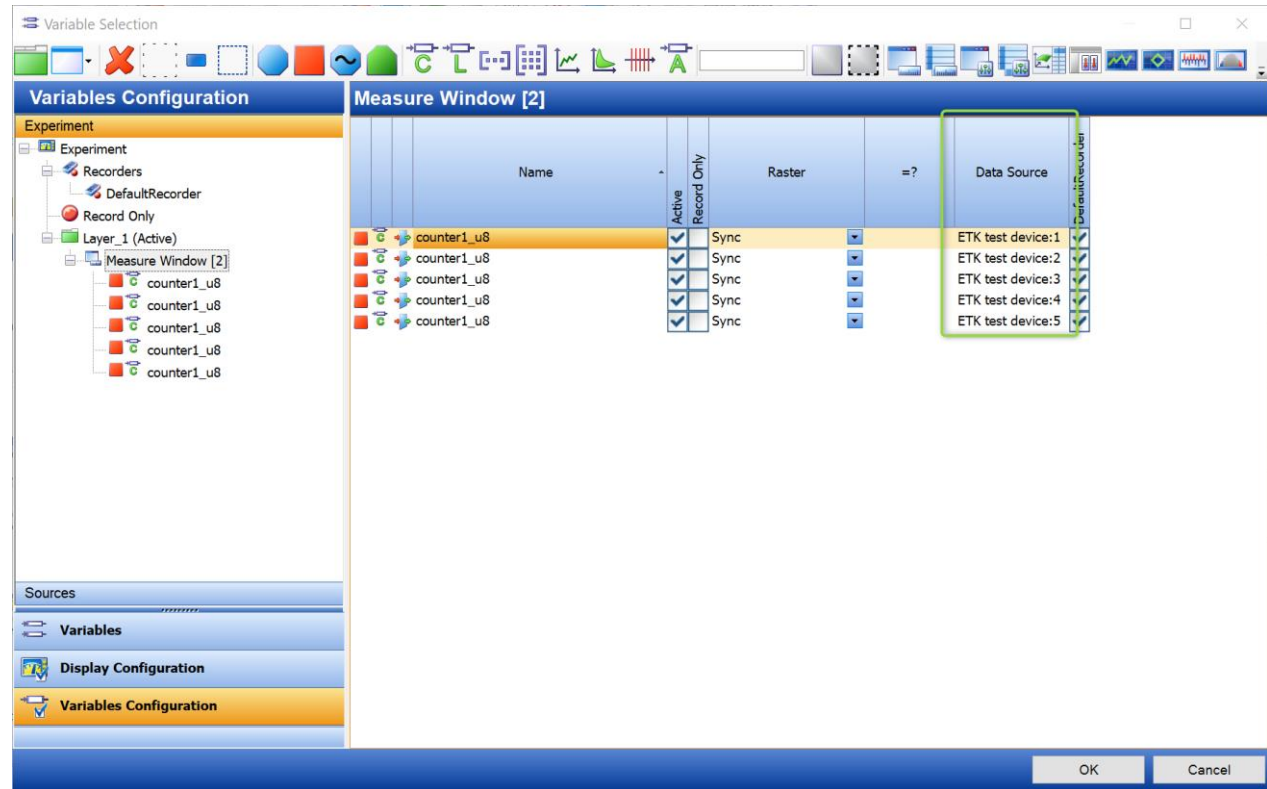

Functionality

VSD – Improved display of measurement array raster from LAB file

For the measure arrays, the summary information about raster from LAB file is shown in the variable tab.

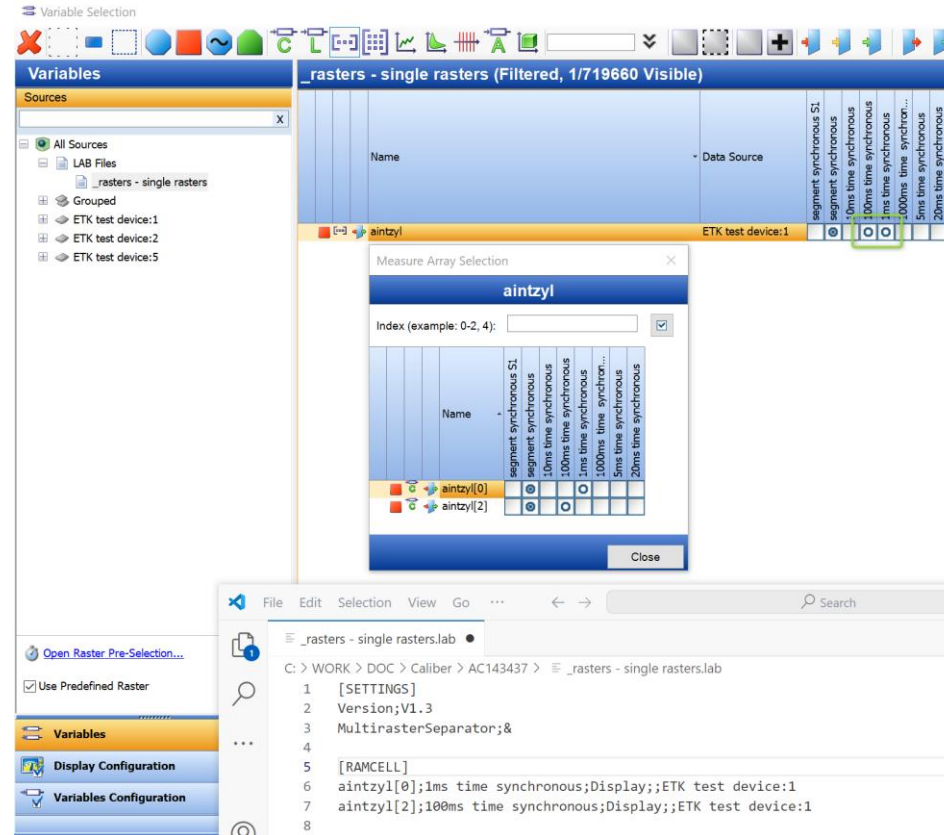

Available with INCA V7.5 SP1

Functionality

DoIP – Protocol Version 3 support for ProF flashing

INCA 7.5 now supports DoIP Protocol Version 3 according to ISO13400-2 of 2019-12 for ProF flashing. The Protocol Version has to be configured in the CNF file of a ProF Configuration:

◆ DOIP_PROTOCOL_VERSION

DOIP_PROTOCOL_VERSION

The keyword DOIP_PROTOCOL_VERSION defines the protocol version to be used for flashing.

```
DOIP_PROTOCOL_VERSION: , <version>;
```

Parameters

version The following use cases are supported with ProF:

Value	Use Case	Supported with INCA version
0x02	DoIP ISO13400-2 as of 2012-06	default value
0x03	DoIP ISO13400-2 as of 2019-12	7.5.0: Only used in DoIP message headers, all other features (for example TLS) are not yet supported.

```
DOIP_PROTOCOL_VERSION: , 0x03;
```

INCA 7.5 does not support other new features of ISO13400-2 of 2019-12. E.g. Transport Layer Security (TLS) is not supported.

Functionality

Experiment – Battery Cell Imbalance Histogram Instrument

- The new Battery Imbalance Histogram shows quickly the distribution of the individual battery cell imbalance values
- A tooltip lists the respective battery cell signal names
- In the Properties window both number of buckets as well as their width can be defined

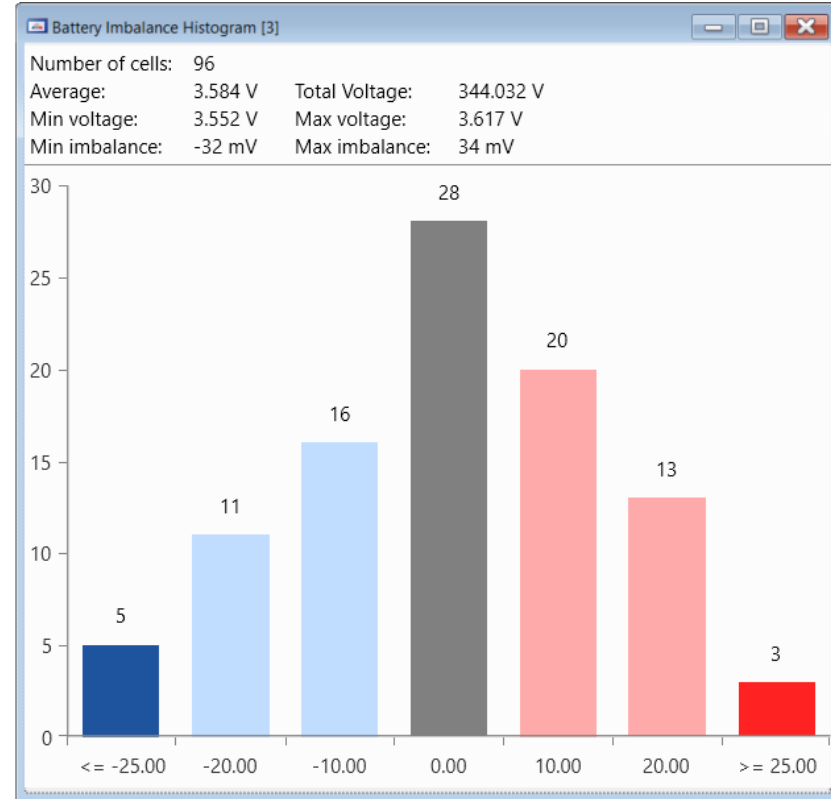

Functionality

Experiment – Battery Voltage Graph in INCA

The Battery Voltage Graph can be used in INCA to measure the voltage and imbalance of the battery cells.

The cells with the voltage out of the ideal range (lower/upper limit) are rendered with different colors.

The average voltage is rendered as a vertical line.

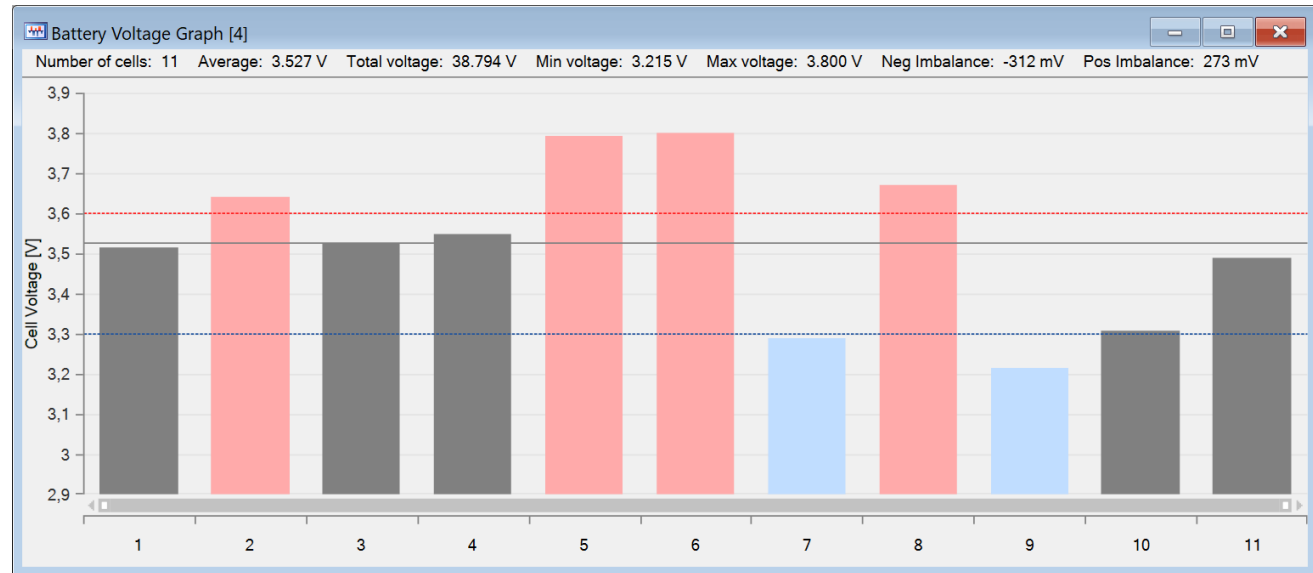

Available with INCA V7.5 SP2

Functionality

Experiment – Export EV instruments in XDA

On recording snapshot, INCA EE exports the XDA file and opens it in MDA; the EV instruments are now also included

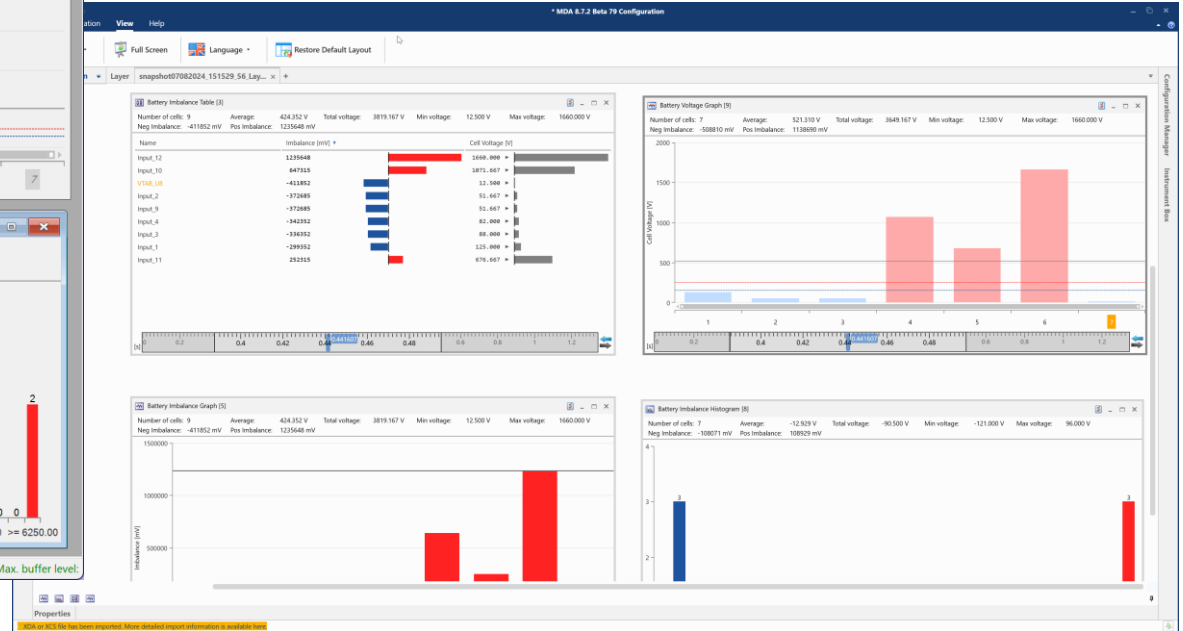
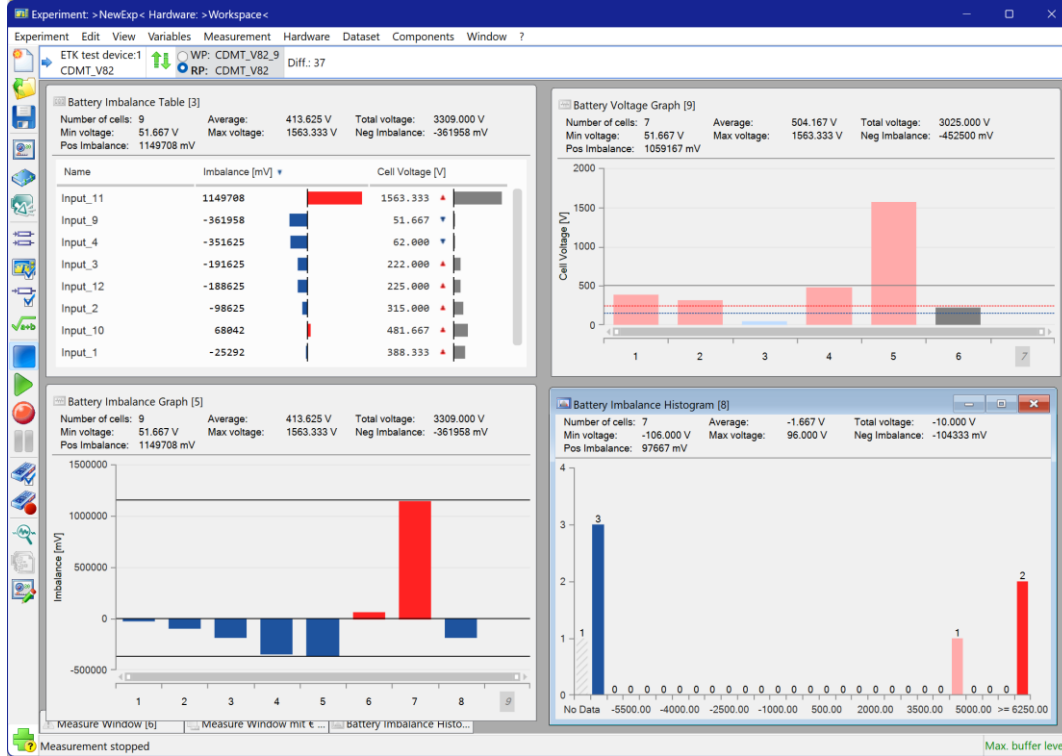

Functionality

INCA Online Help – HTML5 as new format

Enhanced User Interface

- modern and intuitive design
- easier to navigate and find

Responsive Design

- adapting to different screen sizes and devices

Search Functionality

- advanced search with improved search algorithms

The screenshot displays the INCA Online Help interface. At the top, there is a search bar and the ETAS logo. A navigation menu on the left lists various topics such as 'What's New in INCA', 'Getting Started', 'Database Manager', 'Experiment Environment', 'Variable Selection Dialog', 'Memory Page Manager', 'Hardware Configuration Editor', 'Calibration Data Manager', 'ASAM MCD 2MC Editor', 'ASAM MCD 3MC Interfaces', 'INCA Add-On Functionality', 'Troubleshooting', and 'Technical Information'. Below the menu, there are sections for 'Data Protection' and 'Data and Information Security'. The main content area features a large heading 'Welcome to the INCA Help' followed by an introductory paragraph and a diagram of the INCA system architecture. The diagram shows a central 'INCA Database Manager (DBM)' box connected to several subsystems: Hardware Configuration Editor (HWC), Experiment Environment (EE), Variable Selection Dialog (VSD), Recorder Manager (RM), Trigger Editor (TE), Calculated Signals (CS), Add-Ons, User Interface Developer (VUI), Calibration Data Manager (CDM), ASAM-MCD-3MC Interfaces, ASAM-MCD-2MC Editor, and Memory Page Management (MPM).

Functionality

CDM & Experiment – Copy variable names to clipboard

INCA supports copying variable names to the clipboard.

This can be done in the database browser, experiment, variable selection dialog, CDM ...

If multiple variables are marked INCA copies a list of names to the clipboard.

Functionality

INCA – Option to enable/disable Add-ons

INCA supports now the possibility to deactivate add-ons by INCA option.

This allows to install the add-ons on many PCs but use it only on some.

This helps to prevent INCA to allocate licenses for inactive add-ons.

- Add-on QM-BASIC
- Add-on eCDM
- Add-on FLEXRAY
- Add-on LIN

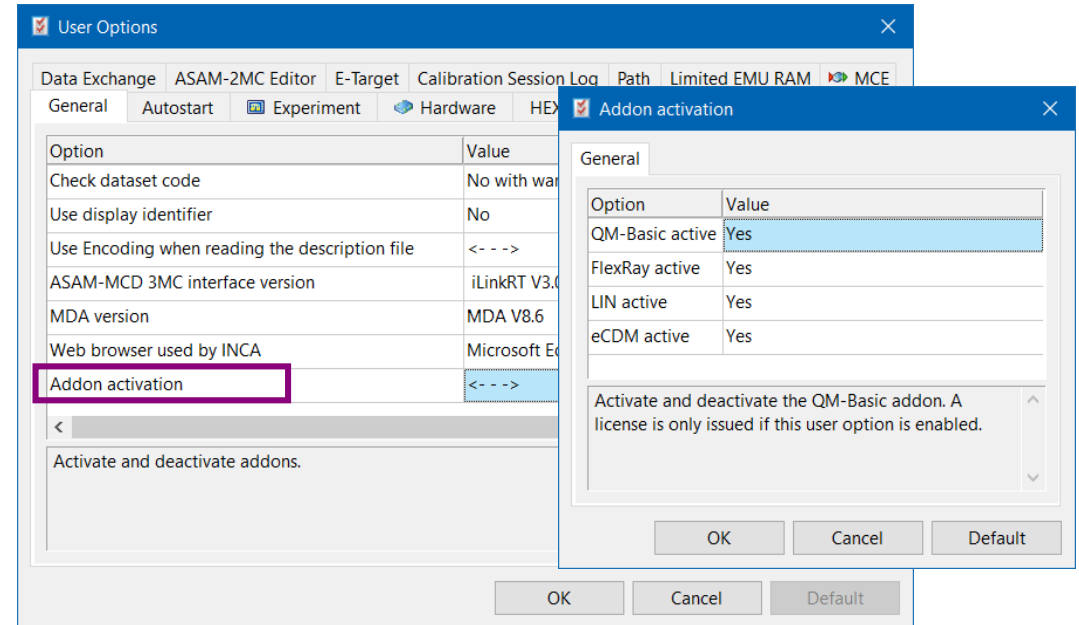

Functionality

LAB File – Options

LAB file supports optional information separated by semicolon

- "Write semicolons" allows to disable not needed semicolons

Support of different use cases

- "LAB file version for CDM" *) allows to pre-select a version used by CDM
- "LAB file version for INCA" *) allows to pre-select a version used by INCA EE / VSD

*) Options can be overwritten when writing LAB files

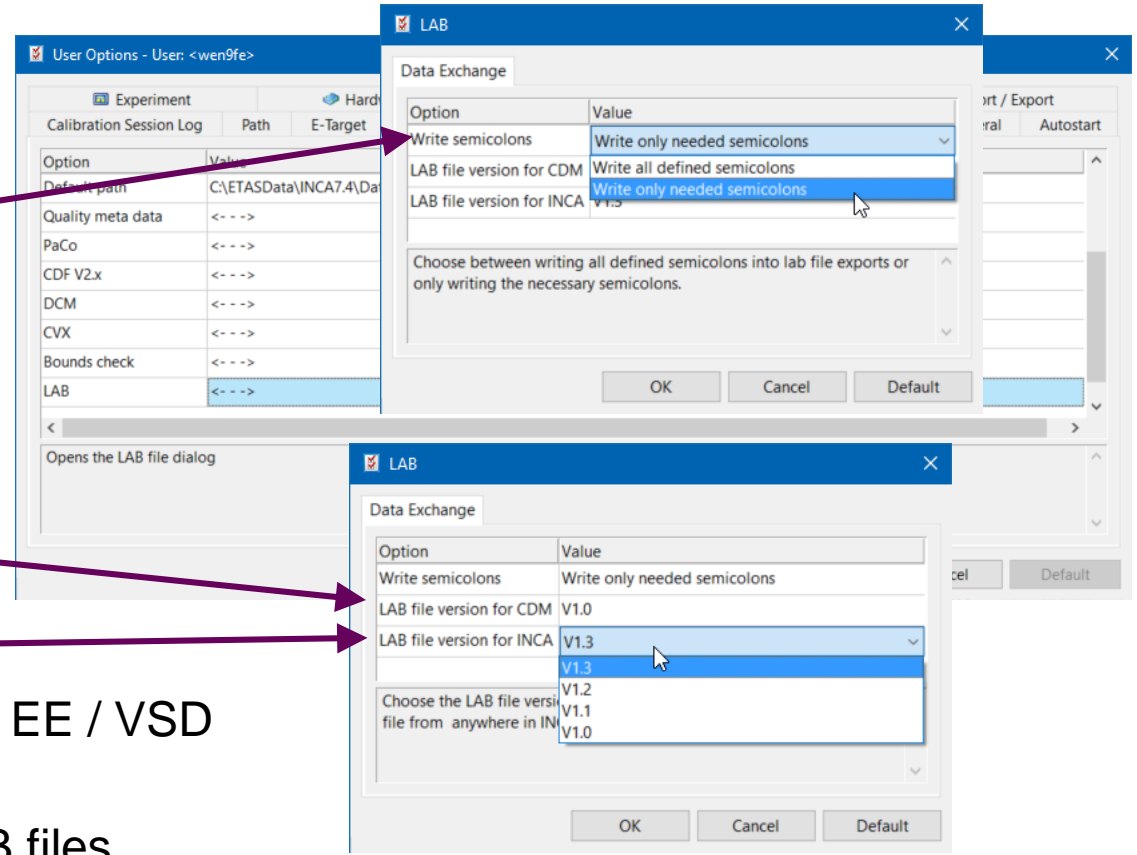

Functionality

Pre-configuration of connection behavior and measure failure behavior

- The device options "Measure failure behavior" and "Connection behavior" can be preconfigured in the user options for newly created INCA native devices.
- Default for "Measure failure behavior": "Retry always"
- Default for "Connection behavior": "Reinitialize automatically"

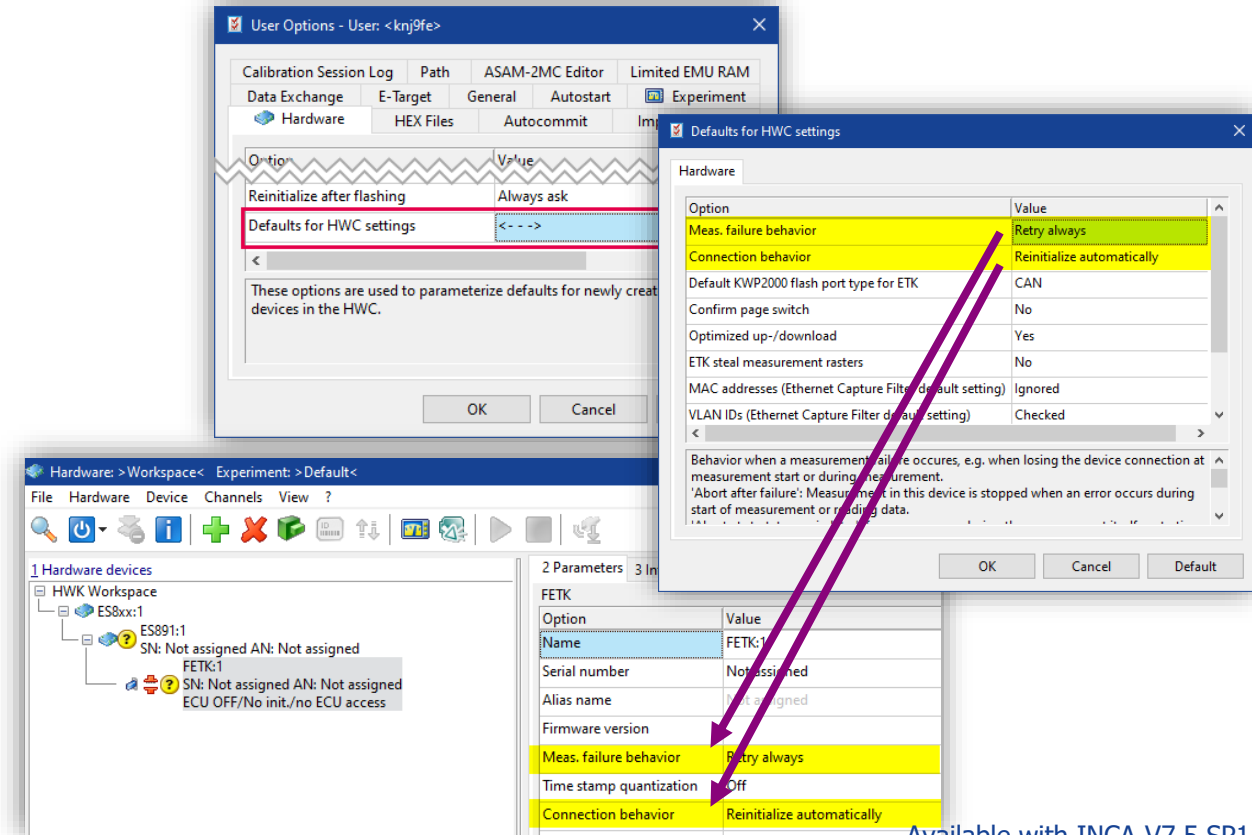

Available with INCA V7.5 SP1

INCA V7.5 – What's New

Functionality

Defaults for frame filtering as user option

- The filter for Ethernet Traffic received on SOME/IP-Monitoring or Ethernet-Monitoring devices can be configured individually for every device.
- The new options allow a pre-configuration for newly created devices.
- The option is stored in the INCA.ini of the user profile such that during the INCA installation the setting can be distributed.

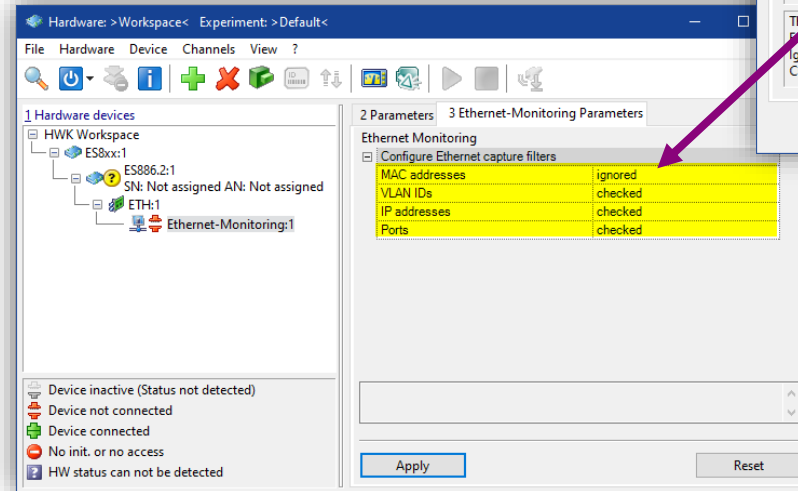
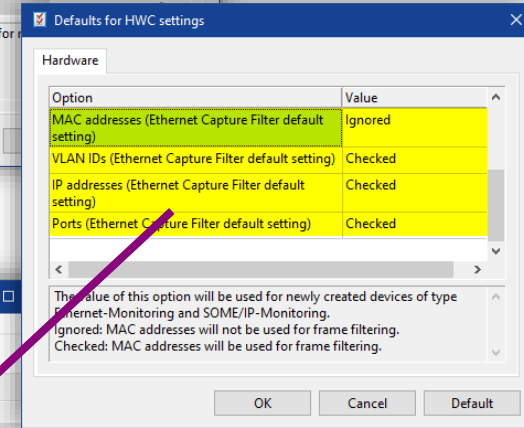
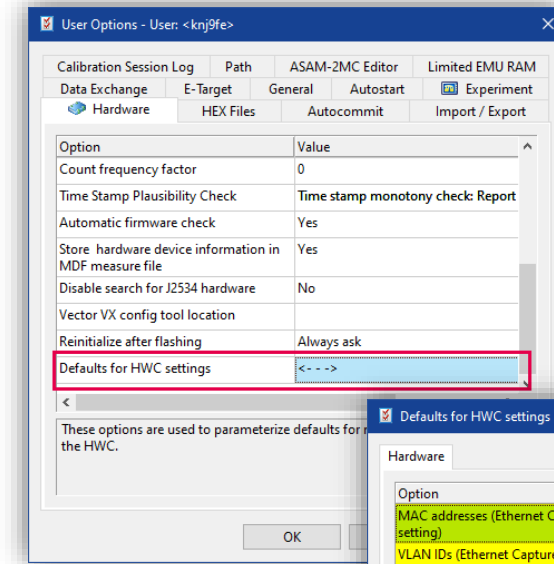

Functionality

CDM – Multi Column – use index as column header

- Show more columns by reducing column width
- Reference dataset name in the destination overview by index
- Show dataset name + path with mouse over index

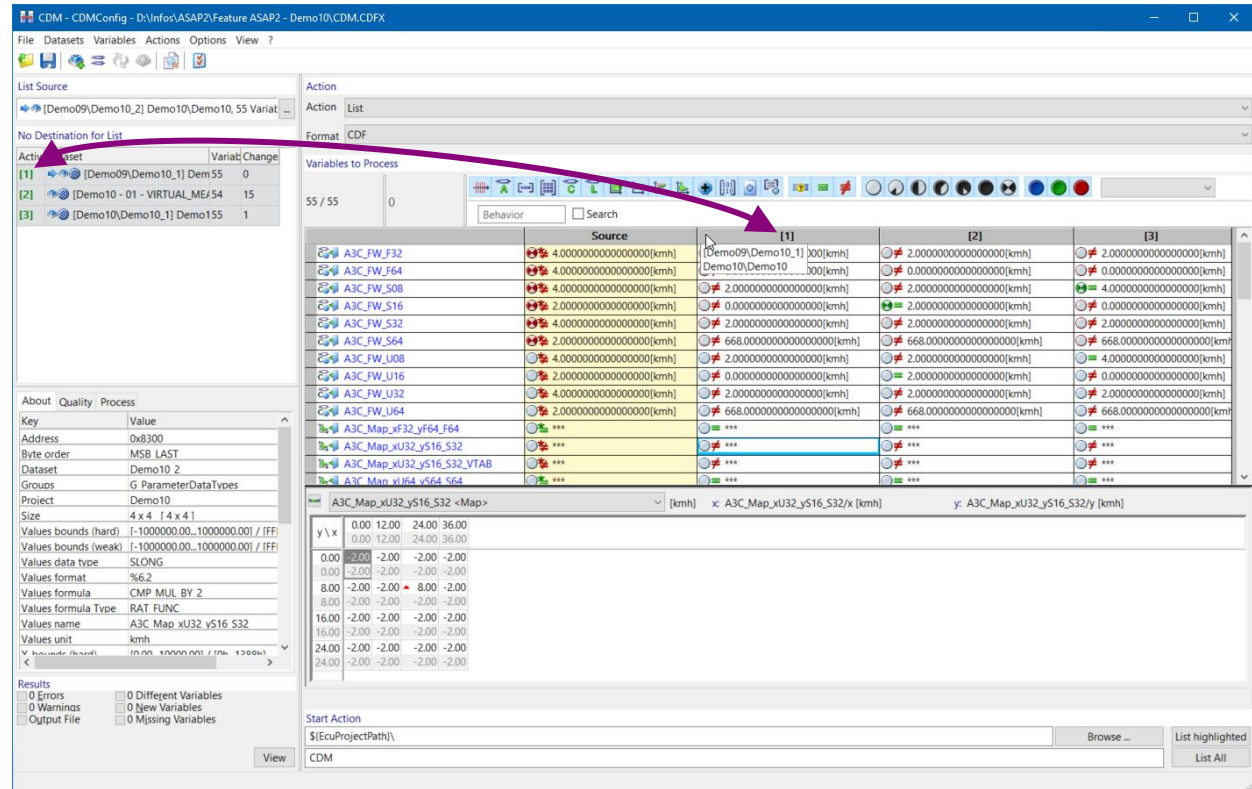

Functionality

COM-API – Change device selection (A2L file) for FETK

For FETK there can be multiple device types defined in the A2L file. INCA allows to select one of it before initializing the hardware by COM API.

Embedded UI of external config module

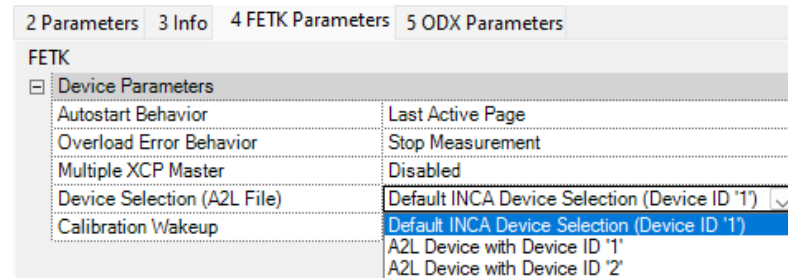

Additionally INCA offers now two more methods to handle option settings

```
public virtual bool SetOption(  
    string aParameterString  
)  
public virtual string GetOption(  
    string aParameterString  
)  
public virtual string GetOptionInformation(  
    string aParameterString  
)
```



```
public virtual string GetOptionHelpText(  
    string aParameterString  
)
```



```
public virtual string[] GetOptionNames(  
    string aParameterString  
)
```

Functionality

COM-API – Create Empty Dataset

INCA requires a data set for calibration access. The data set contains a copy of the ECU memory segment where calibration parameters are located. If there is no HEX file to create a data set, it's necessary to have an 'empty' data set to do an upload from the ECU memory.

There is now a new COM API function **Asap2Project.CreateEmptyDataSet()** which creates an empty data set for the ASAP2 project.

Functionality

COM-API – Change device selection (A2L file) for XETK

There can be multiple devices defined in the A2L file. INCA allows to select one of them before hardware initialization. This setting is now accessible via COM API.

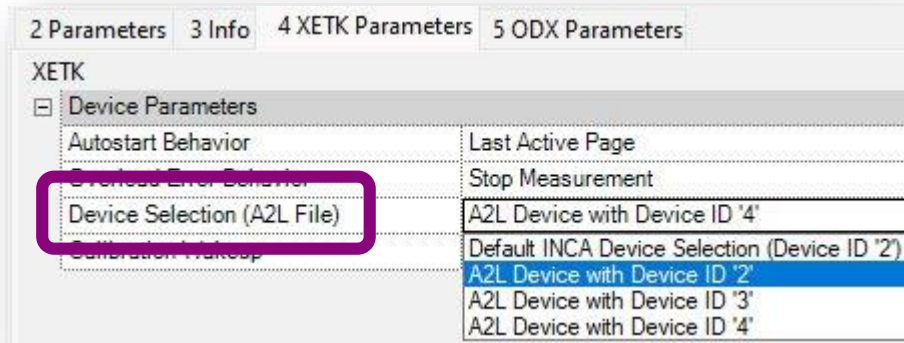

Embedded UI of external config module

[Link to example script and export file](#)

INCA V7.5 – What's New

Functionality

Variable units in VSD and oscilloscopes

The phys unit defined in the ECU project is shown.

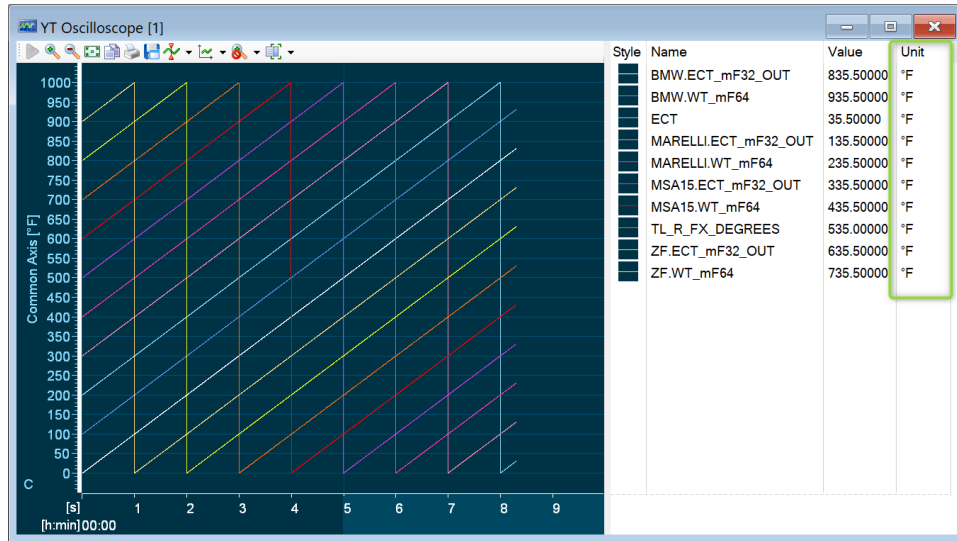

Name	Data Source	Unit	Description
BMW.ECT_mF32_OUT	ETK test device:1	°F	Engine coolant temperature, deg F.
BMW.WT_mF64	ETK test device:1	°F	Water temperature, deg F.
ECT	ETK test device:1	°F	Engine coolant temperature, deg F.
MARELLI.ECT_mF32_OUT	ETK test device:1	°F	Engine coolant temperature, deg F.
MARELLI.WT_mF64	ETK test device:1	°F	Water temperature, deg F.
MSA15.ECT_mF32_OUT	ETK test device:1	°F	Engine coolant temperature, deg F.
MSA15.WT_mF64	ETK test device:1	°F	Water temperature, deg F.
TL_R_FX_DEGREES	ETK test device:1	°F	Berechnete Last
ZF.ECT_mF32_OUT	ETK test device:1	°F	Engine coolant temperature, deg F.
ZF.WT_mF64	ETK test device:1	°F	Water temperature, deg F.

BMW.ECT_mF32_OUT	Sync
Data Source: ETK test device:1	
Type: Scalar	
Address: 0x4D60	
Unit: °F	
Description: Engine coolant temperature, deg F.	

Available with INCA V7.5 SP2

Functionality

AUTOSAR – SecOC "Authentication Information" Signals

A Secured I-PDU of SecOC communication consist of an optional Secured I-PDU Header and an Authentic I-PDU followed by the optional Freshness Value and the Authenticator.

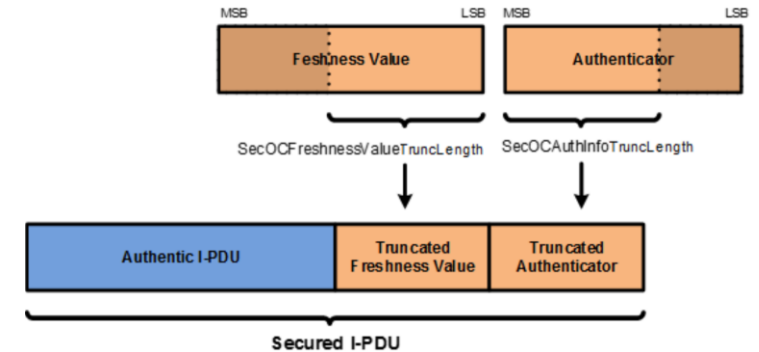

This data can now be measured with INCA by providing additional scalar measurement signals for Authentication Information based on the AUTOSAR description file (supporting AUTOSAR 4.3.0 or higher).

The functionality is available for CAN-, Ethernet- and FlexRay-Monitoring. The new signals have an “_AuthInfo” postfix.

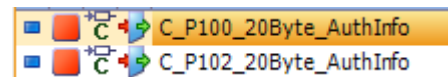



AUTOSAR – Allow switching between SecuredIPdu name and ISignalIPdu name for Signals in Ethernet-Monitoring

- Extends the existing ability to customize Autosar signal names with Pdu name switching for Ethernet-Monitoring
- In case of SecOC, the extension of the signal name by the Pdu name can be switched between the name of the SecuredIPdu and the name of the ISignalIPdu.

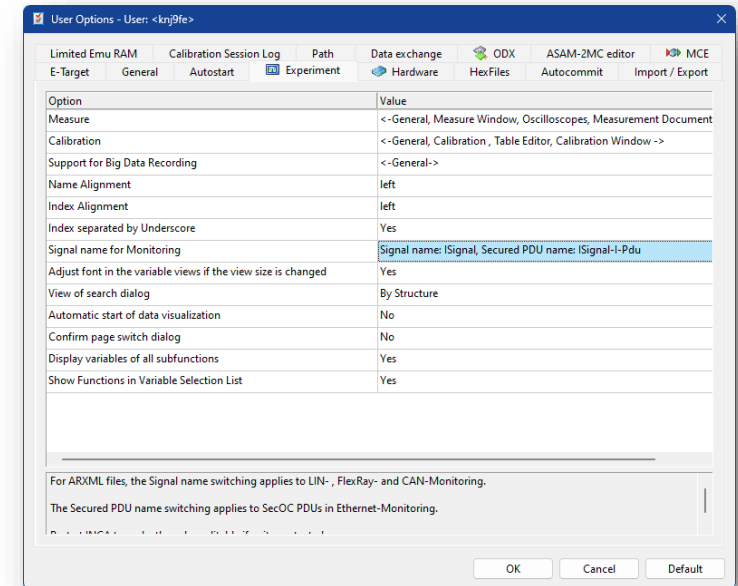



PDU and SOME/IP Monitoring on TCP/IP

Beside the already supported monitoring of UDP communication also TCP communication is supported.

```
<TP-CONFIGURATION>  
  <TCP-TP>  
    <TCP-TP-PORT>  
      <PORT-NUMBER>1234</PORT-NUMBER>  
    </TCP-TP-PORT>  
  </TCP-TP>  
</TP-CONFIGURATION>
```

- For the user, the general handling of signals from TCP is the same as that of signals from UDP.
- To synchronize to the streaming oriented TCP each received TCP frame is treated as if containing the start of a PDU at the start of the payload.

Functionality

J1939 Support CAN-FD as Transport Layer



- Monitoring of CAN signals based on J1939-22
- DBC file as description format similar as for J1939-21, only the Bus Type must be given as FD
- Support of:
 - Multi-PG format with 29 Bit CAN ID
 - Multi-PG format with 11 Bit CAN ID
 - FD Transport Protocol format

Hint: As the DBC description files always contain 29 Bit CAN IDs for the J1939 protocol, the Prio and Destination from the DBC description file are treated as wildcards on receiving an 11 Bit CAN ID.

HW Support

INCA V7.5 – What's New

HW Support

ES58x.2 INCA integration

- The new ES582.2 and ES584.2 supporting CAN FD SIC and thus up to 8 MBaud are available in INCA
- New combined USB-C / USB-A plug
- Transparent INCA support: ES58x.1 and ES58x.2 share the same device type to ensure compatibility of workspaces also in mixed environments.
- If the high baud rate of 8 MBaud shall be used with an ES58x.1 the user is informed about the mismatch during the initialization.



INCA V7.5 – What's New

HW Support

ES570 Support

- 4 channels Automotive Ethernet 1000Base-T1
- Configurable up to 2 TAP (with failsafe relay) on AE ports
- Time synchronization with IEEE1588
- In vehicle (TAP): IEEE802.1AS relay
- Device configuration in WebUI
- Host connection 2500Base-T

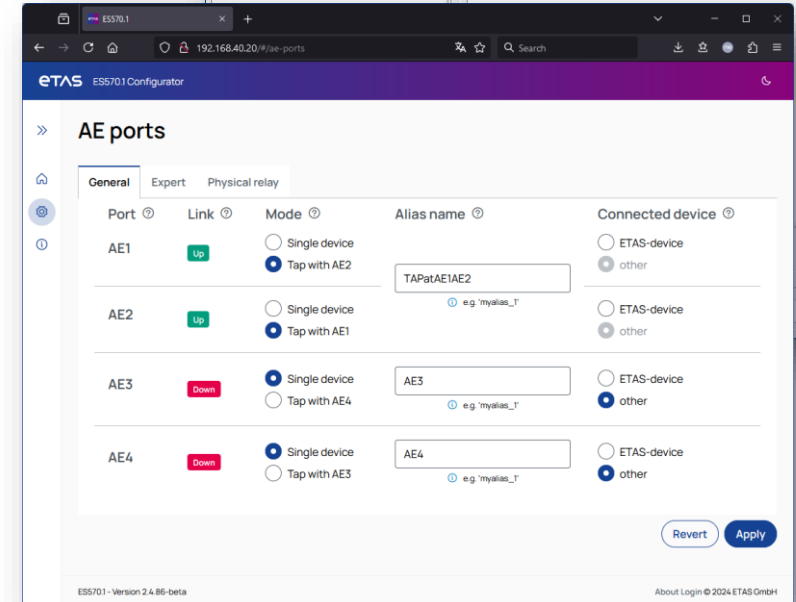
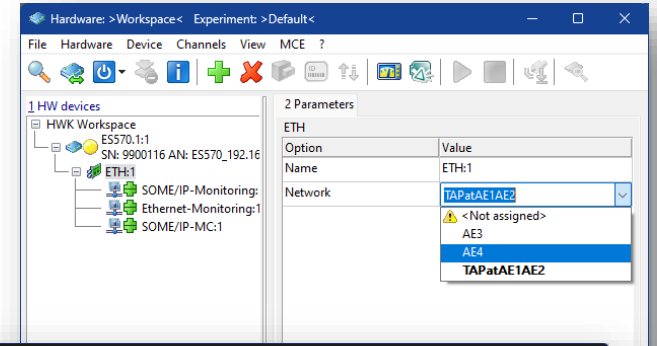
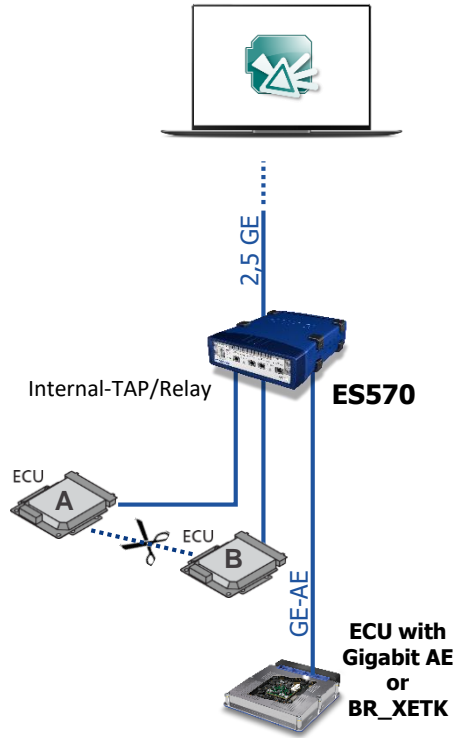

Available with INCA V7.5 SP3

Add-ons

INCA V7.5 – What's New

Add-ons

MCE – Direct ECU access with MCE PC

MCE PC based on Linux for high speed data transfer with ASAM iLinkRT protocol

- High speed data transfer for
 - XCPonETH
 - XETK
 - FETK
- All other devices for measurement, monitoring ... can be accessed in parallel with standard speed

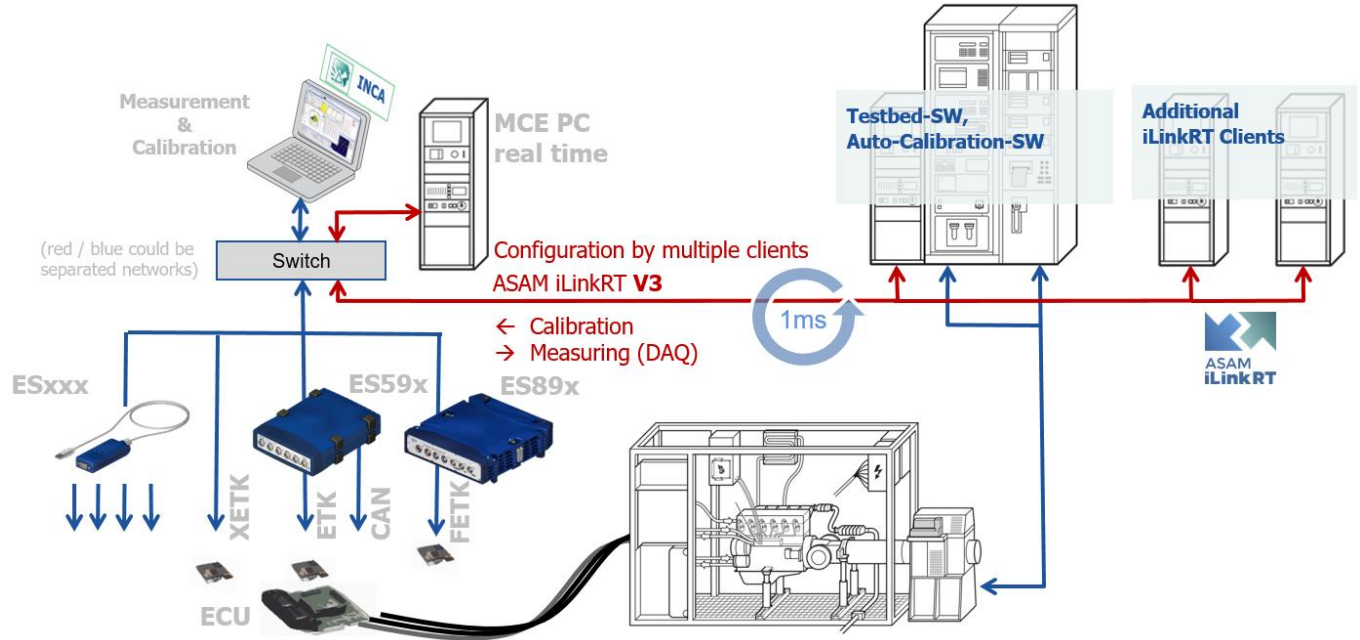

Available with INCA V7.5 SP3

Add-ons

ODX – SAEJ1979-DA 2023-05 – Updated OBDonCAN and OBDonUDS ODX projects

OBDonCAN:

- New mode 1 and mode 2 PIDs \$CE-\$DA
- New mode 9 InfoTypes \$81 and \$85-\$AE

OBDonUDS:

- New Service \$22 PIDs \$F4CE-\$F4DA
- New Service \$22 InfoTypes \$F881 and \$F885-\$F8AE

All new PID and InfoType response parameters are available as measurement signals in the Variable Selection Dialog for measurement and recording with INCA.

The OBD Window displays all new data when using it with the new ODX projects.

The new ODX projects get installed with the INCA-ODX Addon into ETASData\ODX7.5\Projects:

- OBDonCAN_ETAS_SAEJ1979_2023-05.pdx
- OBDonUDS_ETAS_SAEJ1979-2_2023-05.pdx

To use the new functionality the new ODX projects have to be imported into INCA and assigned to a Workspace with an OBDonCAN or OBDonUDS device.

Add-ons

ODX – SAEJ1979-DA 2024-04 – Updated OBDonCAN and OBDonUDS ODX projects

OBDonCAN:

- New PIDs \$DB, \$DC changed PIDs \$1C, \$AD removed PID \$CA
- New InfoTypes \$97, \$AF-\$BE changed InfoType \$A3

OBDonUDS:

- New PIDs \$F4DB, \$F4DC changed PIDs \$F41C, \$F4AD removed PID \$F4CA
- New InfoTypes \$F897, \$F8AF-\$F8BE changed InfoType \$F8A3

All PID and InfoType response parameters are available as measurement signals in the Variable Selection Dialog for measurement and recording with INCA.

The OBD Window displays all new data when using it with the new ODX projects.

The new ODX projects get installed with the INCA-ODX Addon into `ETASData\ODX7.5\Projects`:

- `OBDonCAN_ETAS_SAEJ1979_2024-04.pdx`
- `OBDonUDS_ETAS_SAEJ1979-2_2024-04.pdx`

To use the new functionality the new ODX projects have to be imported into INCA and assigned to a Workspace with an OBDonCAN or OBDonUDS device.

[Available with INCA V7.5 SP3](#)

INCA V7.5 – What's New

Add-ons

MATLAB – Support of MATLAB 2024A

– INCA-SIP & INCA-MIP

INCA V7.5 – What's New

Add-ons

MATLAB – Support of MATLAB 2024B

– INCA-SIP & INCA-MIP

Add-ons

VN-Converter (INCA Variable Name Converter)

- Conversion of variable names in experiments by generic rules
- Rules are defined as regular expressions
- Supported are monitoring devices as well as ECU devices
- Documentation included in INCA help

Hints:

1. The converter is intended to help reusing experiments if due to the feature of switching between ISignal name and SystemSignal name experiment elements are changing.
2. Virtual Measurements are not supported for the conversion (RAMCal, MeasureCal, Calibration Recording) and array elements are only in experiment widgets supported for conversion

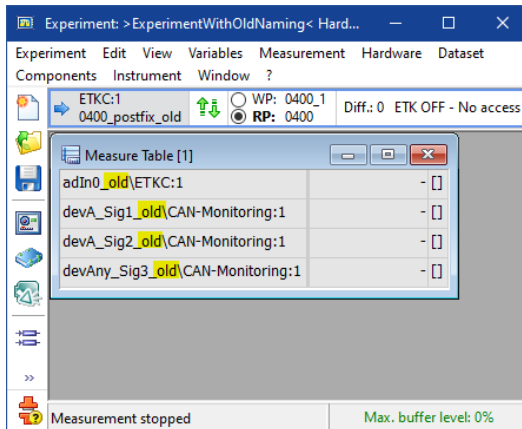

```
;1. old2new  
;exchange suffix_olD by suffix_new  
[OLD2NEW]  
EXP_REGEX=(.*)[_][o][1][d]  
A2L_REGEX=\1[_][n][e][w]
```

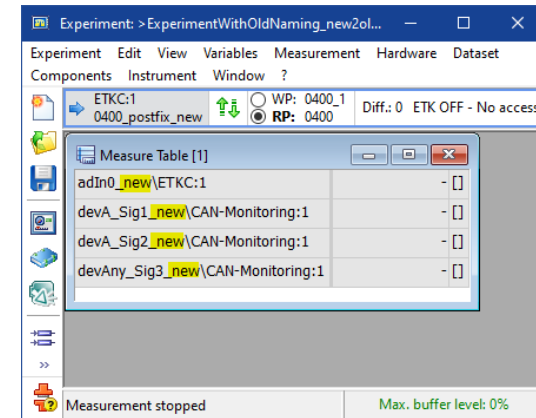

Available with INCA V7.5 SP1

INCA Product Family

INCA V7.5 – What's New

INCA V7.5 – What's New

INCA Product Family

INCA Service Pack Installer – Update from former Minor Version

If INCA V7.5 is installed the first time it checks whether there is a predecessor of INCA V7.4 installed.

The Service Pack Installer shows the previous installation as comment and preselects it for INCA V7.5.

The preselection can be modified.

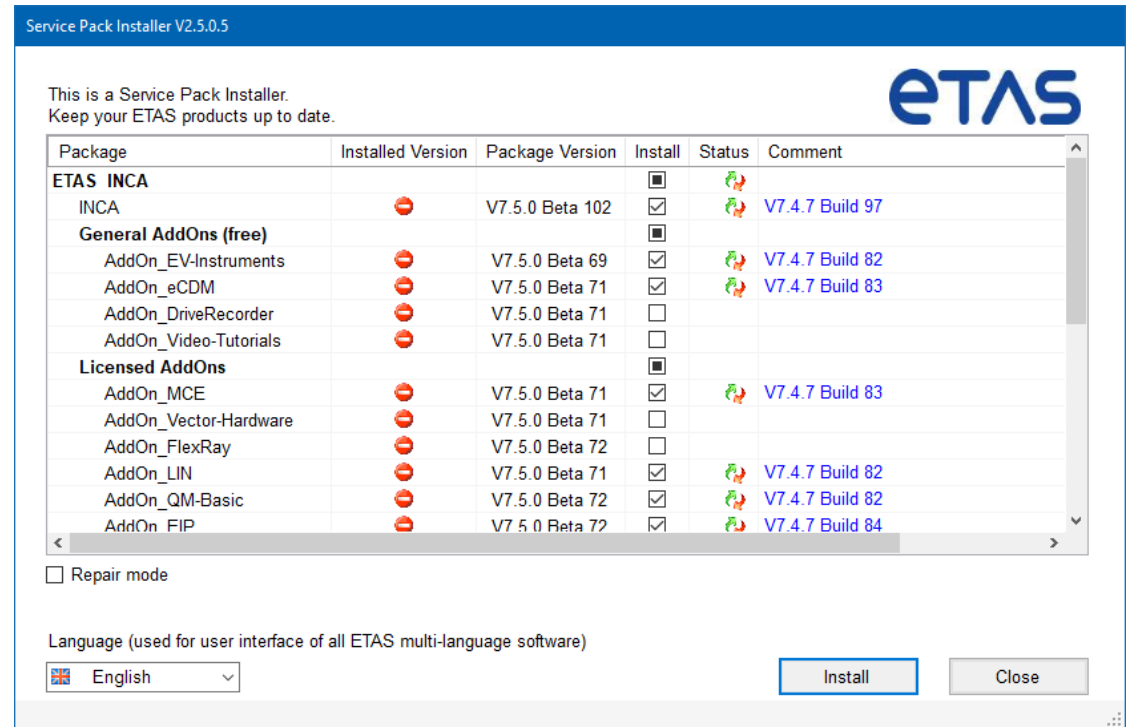

INCA Product Family

Vulnerability check

INCA is scanned for modules that INCA requires to operate. This SBOM (Software Bill Of Material) allows to check the vulnerability of the modules (material) against public vulnerability databases.

Critical modules are exchanged if improved or alternative modules are available.



INCA Product Family

INCA V7.5 license

In order to protect our software and software updates, the products shipped in the INCA V7.5 Service Pack require new licenses.

INCA base software, MDA and all Add-Ons will check for an updated version of their product license.

These license versions are required:

INCA + Add-Ons: 7.5

MDA + Add-Ons: 8.7

Customers with a valid maintenance contract are eligible to receive software updates and will get new licenses.

Please consult the ETAS License Manager documentation for instructions how to update your licenses.

ETAS License Server Update

The following information is relevant for customers using floating or user based licenses. Machine based licenses are not affected.

- The components used for FlexNet Publisher (FNP) licenses will be updated to **FNP V11.19.6**
 - This version supports additionally Windows Server 2022 and Windows 11
 - Contains important bug fixes and addresses known security vulnerabilities

This INCA version does **not** require the new version of ETAS License Server. A version of ETAS License Manager requiring it will be shipped later.

As soon as this package is available, it can be found on [ETAS download center](#)

Phase out information

INCA V7.5 – What's New

Phase out information

Operating Systems

- Windows 8.1 is no longer supported
 - [Microsoft Live Cycle FAQ](#)

Hardware no longer supported

- Vector Channel-Based Mode for VN5610 und VN5640 is no longer supported.
 - The devices can still be used in Network-Based Mode as Vector Ethernet Network
- CANcardXL
- CANcaseXL
- PCMCIA host interface

INCA V7.5 – What's New

Phase out information – Functionality "ASAM MCD-3 MC V2.2"

"ASAM MCD-3 MC V2.2" Test Bench Interface

ASAM decided to focus on the related standards ASAP3 and iLinkRT and to not further develop ASAM MCD-3 MC

Alternative Functionality

– INCA supports ASAM ASAP3 and ASAM iLinkRT

Note: INCA still continues to support ASAM MCD-3 MC V1.0.1. But it is recommended to use ASAP3 or iLinkRT instead

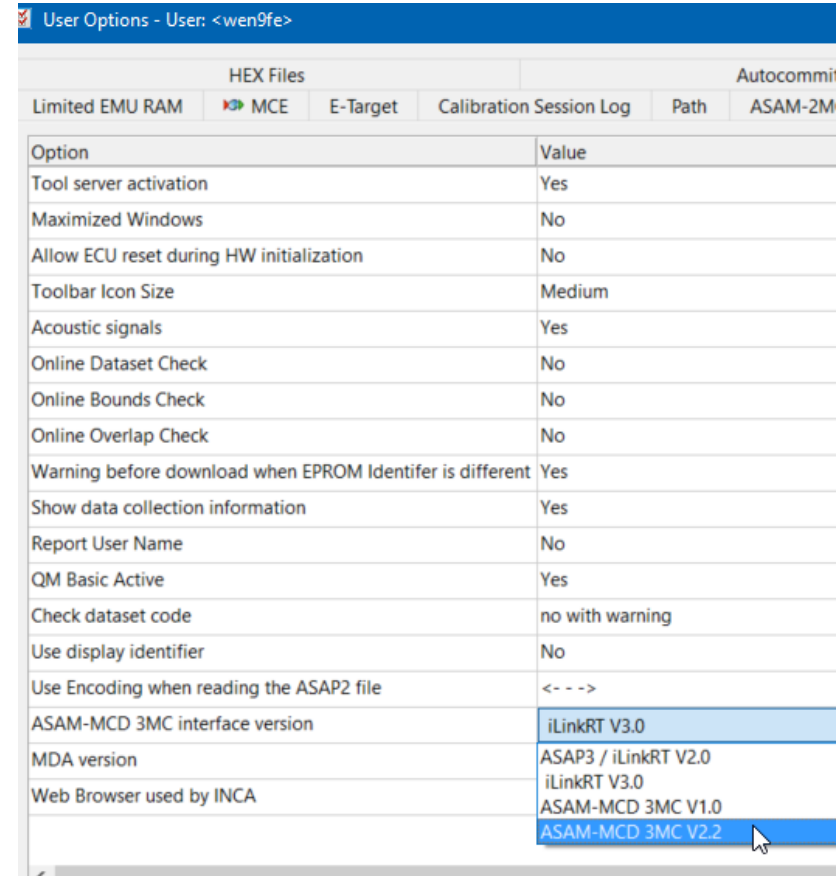

INCA V7.5 – What's New

Phase out information – Functionality "Deliver Project"

"Deliver Project"

Functionality to read / write A2L and Hex files

Alternative Functionality

- The eCDM interface covers the functionality completely and can be used instead
- Further alternatives are "Create Hex File" and "Write A2L File"

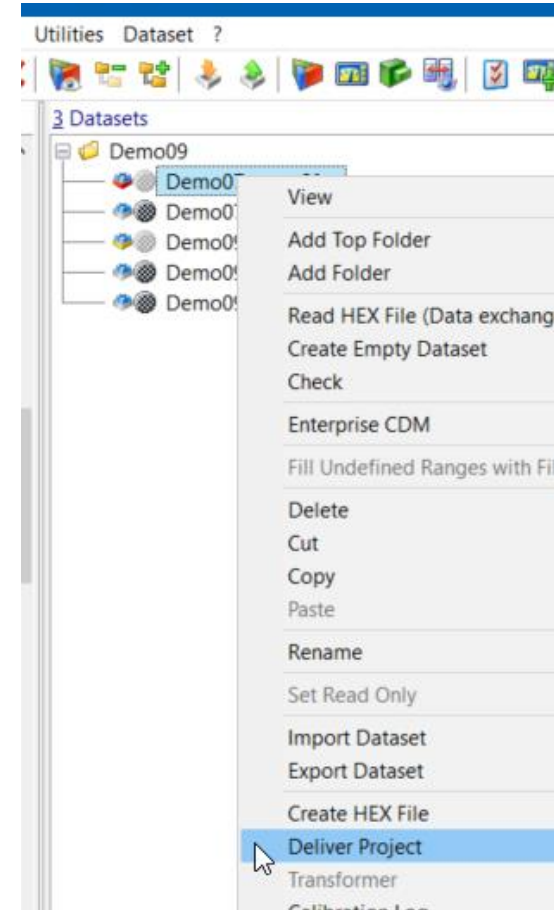

Phase out information – Functionality "MDF3 converter"

"MDF3 converter"

INCA functionality to convert MDF V3 files after recording stop

Alternative Functionality

– Convert MDF files in ETAS MDA

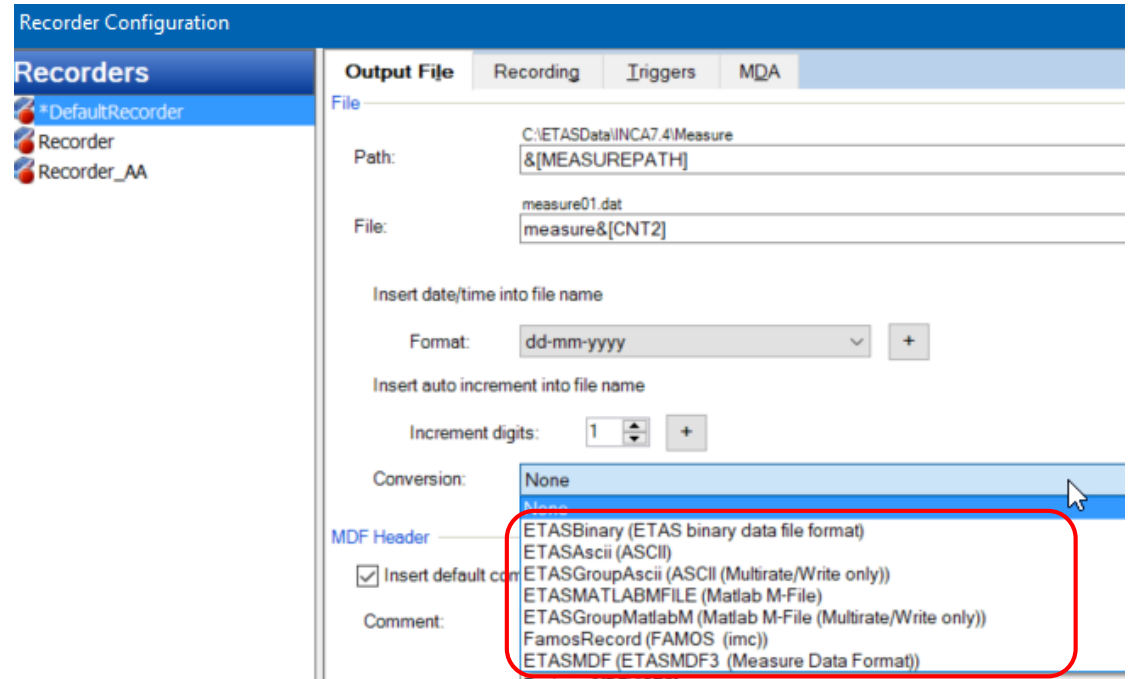

General Notes

INCA V7.5 – What's New

INCA V7.5 – What's New

Overview of Functionality added by Service Packs

Links to Functionality Description of Service Pack 1

- [Ethernet Network Mapping](#)
- [ODX – SAEJ1979-DA 2023-05 – Updated OBDOnCAN and OBDOnUDS ODX projects](#)
- [LAB File – Options](#)
- [ASAP2 TRANSFORMER - Support of 32bit DLL in 64bit INCA](#)
- [Device column at variables configuration grid](#)
- [Pre-configuration of connection behavior and measure failure behavior](#)
- [Defaults for frame filtering as user option](#)
- [AUTOSAR – Support of TLV encoded SOME/IP data](#)
- [AUTOSAR – Monitoring of contained PDUs with not matching sizes](#)
- [AUTOSAR – Allow switching between ISignal name and SystemSignal name](#)
- [VSD – Improved display of measurement array raster from LAB file](#)
- [ES58x.2 INCA integration](#)
- [MATLAB – Support of MATLAB 2024A](#)
- [VN-Converter \(INCA Variable Name Converter\)](#)

INCA V7.5 – What's New

Overview of Functionality added by Service Packs

Links to Functionality Description of Service Pack 2

- [CDM – Multi Column – use index as column header](#)
- [COM-API – Change device selection \(A2L file\) for FETK](#)
- [Reuse of Battery Voltage Graph in INCA](#)
- [Export EV instruments in XDA](#)
- [Variable units in VSD and oscilloscopes](#)
- [AUTOSAR – SecOC "Authentication Information" Signals](#)

INCA V7.5 – What's New

Overview of Functionality added by Service Packs

Links to Functionality Description of Service Pack 3

- [ODX – SAEJ1979-DA 2024-04 – Updated OBDOnCAN and OBDOnUDS ODX projects](#)
- [J1939 Support CAN-FD as Transport Layer](#)
- [HWC – Enhance the system mapping dialog](#)
- [COM-API – Create Empty Dataset](#)
- [COM-API – Change device selection \(A2L file\) for XETK](#)
- [MC-Gateway – Access to Micro Processor based Control Units](#)
- [ETK – Multiple DAQs per raster](#)
- [AUTOSAR – Allow switching between SecuredIPdu name and ISignalIPdu name for Signals in Ethernet-Monitoring](#)
- [PDU and SOME/IP Monitoring on TCP/IP](#)
- [ES570 Support](#)
- [ES134 – Integration in INCA – LIN to Ethernet](#)
- [MCE – Direct ECU access with MCE PC](#)
- [MATLAB – Support of MATLAB 2024A](#)

General Notes

Compliance to General Data Protection Regulation

Please note that personal data is processed when using INCA. As the controller, the purchaser undertakes to ensure the legal conformity of these processing activities in accordance with Art. 4 No. 7 of the General Data Protection Regulation (GDPR).

As the manufacturer, ETAS GmbH is not liable for any mishandling of this data.

Data categories

Please note that INCA particularly records the following personal data (categories), and/or data (categories) that can be traced back to a specific individual, for the purposes of assisting with troubleshooting

- Communication data: IP address, date and time
- User data: The user's Windows UserID

Further information to this topic is available in the INCA installation handbook and the INCA online help.

General Notes

Customer Instruments

INCA supports the possibility to add customer programmed instruments to the INCA Experiment.

INS.DK (Instrument Development Kit)

- Quick Start Guide to setup the development environment
- Tutorial that guides you through implementing
- Instrument wizard and a C# project template for Visual Studio
- Usable examples of instruments
- Test environment for instruments
- Documentation of the INCA Instrument API

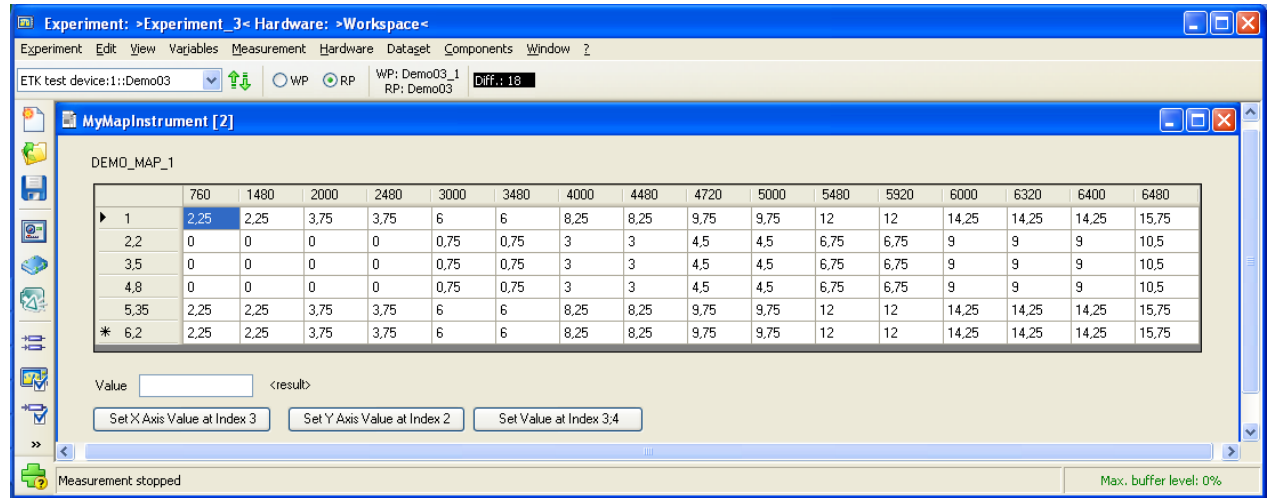

The INS.DK is available in the INCA Service Pack Installer under "`\\01_INCA_V7.5.x\INCA-INS.DK\INCA-INS.msi`"

General Notes

Seminars offered at ETAS Locations Worldwide or at Customer Site

Deep skills and sound knowledge are essential prerequisites for handling software tools of ever-rising complexity. Our trainers are highly experienced engineers in the field of engineering and support, who relish sharing knowledge on ETAS products and development processes. Target groups for the trainings are beginners, advanced users and those who wish to expand their existing knowledge. All trainings are offered at the ETAS Academy or on site at the customer's. INCA Application is offered as presence or online training.

INCA – Calibration (3 days)

- Practical operation of the software and the knowledge of the INCA fundamentals
- Get to know the advantages and disadvantages of various calibration concepts

INCA - Advanced Calibration Techniques (2 days)

- Advanced functionalities in INCA, Tips & Tricks. INCA experience is required
- EHANDBOOK Navigator, INCA Flow

INCA - FLOW Coaching

- Using your own calibration tasks to see the benefits of INCA-Flow in your daily work

Some ETAS local offices have their own training programs which are specialized for the local needs. Please contact our local office of your area for the details: <https://www.etas.com/en/trainings.php>

General Notes

Usage of virtual PC Machines

The usage of INCA on a virtual machine (VM) is restricted and not recommended:

- The VM needs sufficient working memory (RAM), otherwise the performance of INCA goes down
- Access to sufficient graphic card memory (Direct X) is necessary, otherwise the oscilloscope representation of measurement signal is not possible
- Access to hardware interfaces Ethernet, USB, PCMCIA, ... is necessary, otherwise INCA cannot use the connected hardware
- Measure samples may be lost and the accuracy of time stamps is not guaranteed as the higher task priority for hardware access (Target Server) is not given
- ETAS does no special tests concerning VM machines

ETAS recommends to use real PC hardware.

General Notes

Minimum System Requirements

- 2 GHz Processor, 2 GB RAM, and DVD-ROM drive *)
- Graphics: at least 1024x768, 256MB RAM, 16bit color and DirectX 9

Recommended System Requirements

- 3 GHz Quad-Core Processor, 16 GB RAM, and DVD-ROM drive *)
- Graphics: at least 1280x1024, 1GB RAM, 32bit color and DirectX 9
- Windows 10 64Bit
- Investigation on performance showed
 - More Memory improves execution time of repetitive operations
 - SSD Hard disks improve the file access times

Supported OS

- Windows 10 64Bit Pro / Enterprise
- Windows 11 64Bit Pro / Enterprise
- Windows Server 2016 64Bit / 2019 64Bit / 2022 64Bit
- See also <https://learn.microsoft.com/en-US/lifecycle/>

*) Needed for installation via DVD only
Not necessary when installing via network

General Notes

Additionally Installed Components	INCA V7.4	INCA V7.5
.Net-Runtime-Environment	V4.8 ¹⁾	V4.8 ¹⁾
VCxRedist (Vcredist_x86 / Vcredist_x64)	VC9+VC10+VC14	VC14.38.33130.0 (or higher)
JAVA SDK Version j2sdk1.4.2_11	X ²⁾	X ²⁾
Perl V5.30.0	X	X
ETAS Certificate	X	X
Direct X	V9 (or higher)	V9 (or higher)
ETASShared	14	15
Windows 8.1 64Bit	X ^{3) 5)}	-
Windows 10 64Bit	X ³⁾	X ³⁾
Windows 11 64Bit	X	X
Windows Server 2016 64Bit / 2019 64Bit	X	X
Windows Server 2022 64Bit	X ⁶⁾	X
¹⁾ This component is installed only when no or an older version is installed. If a newer version is already installed, it will not be touched. This is checked by a Microsoft installation routine. ²⁾ This component is installed only with ODX LINK ³⁾ For hardware driver support see release notes ⁵⁾ .NET V4.8 needed (available from Microsoft Support .NET V4.8) ⁶⁾ beginning with INCA V7.4 SP2		

Thank you!