



INCA V7.2 – What's New

Changes / Extensions compared to INCA V7.1

INCA V7.2 – What's New

Overview

1. Product information (Use cases, Sample applications, Customer value)

- Performance
- Functionality
- Standards
- Usability
- HW support
- Add-ons

2. INCA Product Family

3. Phase out information

4. General Notes



INCA V7.2 – What's New

Overview

1. Product information (Use cases, Sample applications, Customer value)

- Performance

- **Functionality**

- Standards

- Usability

- HW support

- Add-ons

2. INCA Product Family

3. Phase out information

4. General Notes



INCA V7.2 – What's New

Functionality

CCP – Set Default CAN-ID for DAQs to CCP Response ID

- INCA 7.2 listens to data sent with response CAN-ID as default, when the CAN_ID_FIXED is empty or 0x00 in the QP_BLOB of the ASAP2 file.

- Example:

```
...
/begin TP_BLOB
  0x0201
  0x0206
  0x4F0 /* Command CAN-ID */
  0x31E /* Response CAN-ID */
  0x25
[...]
```

```
/begin IF_DATA ASAP1B_CCP
/begin SOURCE
  "5ms Raster"
  3 /* 5 ms (CSE) */
  5 /* Rate in Scaling Unit: 5*1ms */
/begin QP_BLOB
  0x00
  LENGTH 0x05
  FIRST_PID 0x00
  [CAN_ID_FIXED 0x31E] → If this entry is missing or 0x00, INCA uses Response CAN-ID
/end QP_BLOB
/end SOURCE
...
```

INCA V7.2 – What's New

Functionality

XCP – ODT Optimization & Measurement Data Consistency

- According to XCP standard, the "Optimization Method" property indicates the kind of optimization method, used by the XCP slave implementation. It should be used by the master to determine the method, used for configuring the ODTs in order to make full use of the CPUs architecture for copying measurement data on ECU.
- INCA 7.2.0 supports this features in combination with the data consistency property (consistency on ODT/DAQ/EVENT)
- From XCP AML:

```
/* from XCP 1.1 onwards */
```

```
"CONSISTENCY" enum
```

```
{  
  "DAQ" = 0,  
  "EVENT" = 1  
};
```

```
/* Default CONSISTENCY on ODT */
```

```
/* from XCP v1.0 onwards */
```

```
enum
```

```
{ /* OPTIMISATION_TYPE */  
  "OPTIMISATION_TYPE_DEFAULT" = 0,  
  "OPTIMISATION_TYPE_ODT_TYPE_16" = 1,  
  "OPTIMISATION_TYPE_ODT_TYPE_32" = 2,  
  "OPTIMISATION_TYPE_ODT_TYPE_64" = 3,  
  "OPTIMISATION_TYPE_ODT_TYPE_ALIGNMENT" = 4,  
  "OPTIMISATION_TYPE_MAX_ENTRY_SIZE" = 5  
};
```



XCP – ODT Optimization & Measurement Data Consistency

- INCA 7.2 SP1 supports additional optimization methods with combination of data consistencies as described in this matrix:

A2L/ECU	OM_DEFAULT	OM_ODT_TYPE_16	OM_ODT_TYPE_32	OM_ODT_TYPE_64	OM_ODT_ALIGNMENT	OM_MAX_ENTRY_SIZE
Consistency on ODT	Map to INCA 7.1 behavior Event Consistency + OM_DEFAULT	INCA 7.2.0	INCA 7.2.0	INCA 7.2.0	INCA 7.2 SP1	INCA 7.2 SP1
Consistency on DAQ	INCA 7.2.0	INCA 7.2 SP1	INCA 7.2 SP1	INCA 7.2 SP1	INCA 7.2 SP1	INCA 7.2 SP1
Consistency on EVENT	INCA 7.1 behavior	INCA 7.2 SP1	INCA 7.2 SP1	INCA 7.2 SP1	INCA 7.2.0	INCA 7.2 SP1

- From XCP AML:

```
/* from XCP 1.1 onwards */
```

```
"CONSISTENCY" enum  
{  
  "DAQ" = 0,  
  "EVENT" = 1  
};
```

```
/* Default CONSISTENCY on ODT */
```

```
/* from XCP v1.0 onwards */
```

```
enum  
{ /* OPTIMISATION_TYPE */  
  "OPTIMISATION_TYPE_DEFAULT" = 0,  
  "OPTIMISATION_TYPE_ODT_TYPE_16" = 1,  
  "OPTIMISATION_TYPE_ODT_TYPE_32" = 2,  
  "OPTIMISATION_TYPE_ODT_TYPE_64" = 3,  
  "OPTIMISATION_TYPE_ODT_TYPE_ALIGNMENT" = 4,  
  "OPTIMISATION_TYPE_MAX_ENTRY_SIZE" = 5  
};
```

Available with INCA V7.2 SP1

INCA V7.2 – What's New

Functionality

XCP V1.3 – Slave detection on Ethernet

With INCA 7.2 SP1 the user can search for connected XCP slaves on Ethernet which support GET_SLAVE_ID command of XCP 1.3. INCA discovers needed parameters (IP address and port number) to establish communication

The image shows a sequence of three screenshots illustrating the XCP slave detection process in INCA V7.2 SP1:

- Left Screenshot:** The 'Hardware devices' tree shows 'Ethernet-System1' with 'XCP-1' selected. The 'Parameters' pane shows 'Ethernet Address' set to '192.168.10.3' and 'Ethernet Port' set to '9000'. A blue callout box points to these fields with the text 'Editable Ethernet parameters'.
- Middle Screenshot:** The 'Device' menu is open, and 'Search/assign XCP slaves...' is selected. A blue callout box points to this menu item with the text 'Search/assign XCP slave'.
- Right Screenshot:** A dialog box titled 'XCP-1' displays the results of the search. It contains a table of found slaves and a blue callout box with the text 'Assign XCP slave' pointing to the table.

IP-Address	Port	TP	Identification
192.168.10.1	9000	TCP-IP	XCP_SLAVE_2
192.168.10.2	9001	BOTH	XCP_SLAVE_3
192.168.10.3	9000	UDP-IP	XCP_SLAVE_1

Available with INCA V7.2 SP1

INCA V7.2 – What's New

Functionality



XCP – Additional Setting for the Source UDP Port in INCA HWC

For the XCP on Ethernet communication the a2I defines the destination IP address and port number, but not the source port.

Some XCP slave are demanding a specific (hard coded) source port for the communication which can now be configured in the HWC window. To support the XCP Resume Mode for UDP the XCP Master has to know the source port to listen for the incoming frames.

The default behavior is that the parameter is empty which means INCA uses a random source port.

If the user configures a specific source port INCA will use this as communication parameter.

Name	XCP:1
Meas. failure behavior	Abort after failure
Time stamp quantization	Off
Connection behavior	Reinitialize automatically
Project working data	DEFAULT\XCP15onTCP Upload\Upload_2
Reference data	Upload\Upload_1
Differences (bytes)	0
Transport Layer Instance	dummyTLName
Ethernet Address (IPv4)	10.35.86.37
Destination Port	9001
Source Port	
Ethernet Protocol Type	TCP-IP
Log out behavior	No Automatic Flash Back
ECU Description Handling	ASAP2
Seed'n Key DLL	
Seed 'n Key Privileges	0 DAQ, 0 CAL/PAG, 0 STIM, 0 PGM
Checksum DLL	
Fast Start	Fast start enabled: No
ECU Connect Mode	NORMAL
Confirm page switch	Yes
Counter Consistency Mode	one counter for all CTOs+DTOs
Check memory pages at initialization	Always check

[Available with INCA V7.2 SP14](#)



LAB File – New Version 1.1 with additional Raster Information

The LAB File contains now, beside the variable name also the raster information. Multi Raster are supported.

- In the Experiment INCA allows to write variables to LAB files
- In the Variable Selection the LAB files can be used as filters
- Compare of Experiments can be done by comparing LAB files

```
[SETTINGS]
Version;V1.1
MultirasterSeparator;&

[RAMCELL]
MyMeasurement01
MyMeasurement02;;Comment
MyMeasurement03;10ms
MyMeasurement04;10ms;Comment
MyMeasurement05;10ms&100ms&sync;Comment Multi Raster

[LABEL]
MyParameter01
MyParameter02;;Comment

[FUNCTION]
MyFunction01
MyFunction02;10ms;Comment

[GROUP]
MyGroup01
MyGroup01;100ms;Comment
```

INCA V7.2 – What's New

Functionality

Key Variable List

- A new Database Item „Key Variables List“ under a project
- Contains an order list including Functions, Groups and Variables
 - Order can be easily edited by the user
- Controls variables used in new or existing Experiments

The following use case are not supported with the initial release.
They will be supported in future INCA versions

- Black list
- Display Identifier
- Raster selection

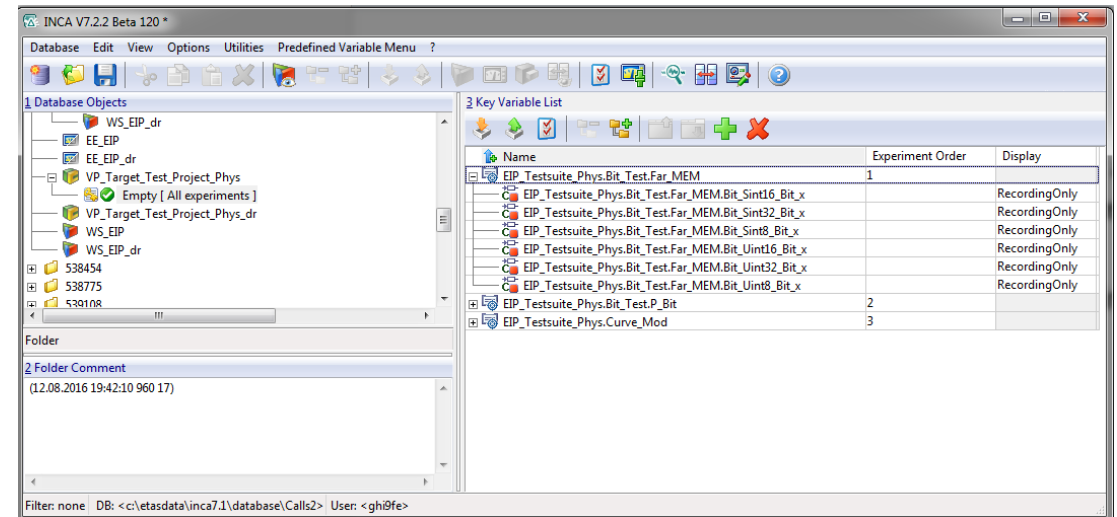

Available with INCA V7.2 SP2

INCA V7.2 – What's New

Functionality



Key Variable List – Black List

“Record All” Signals – but exclude some Signals

- With the Black List INCA adds all Signals from the related ECU excluding the Signals stated in the Black List

- Control whether signals are removed from the Experiment

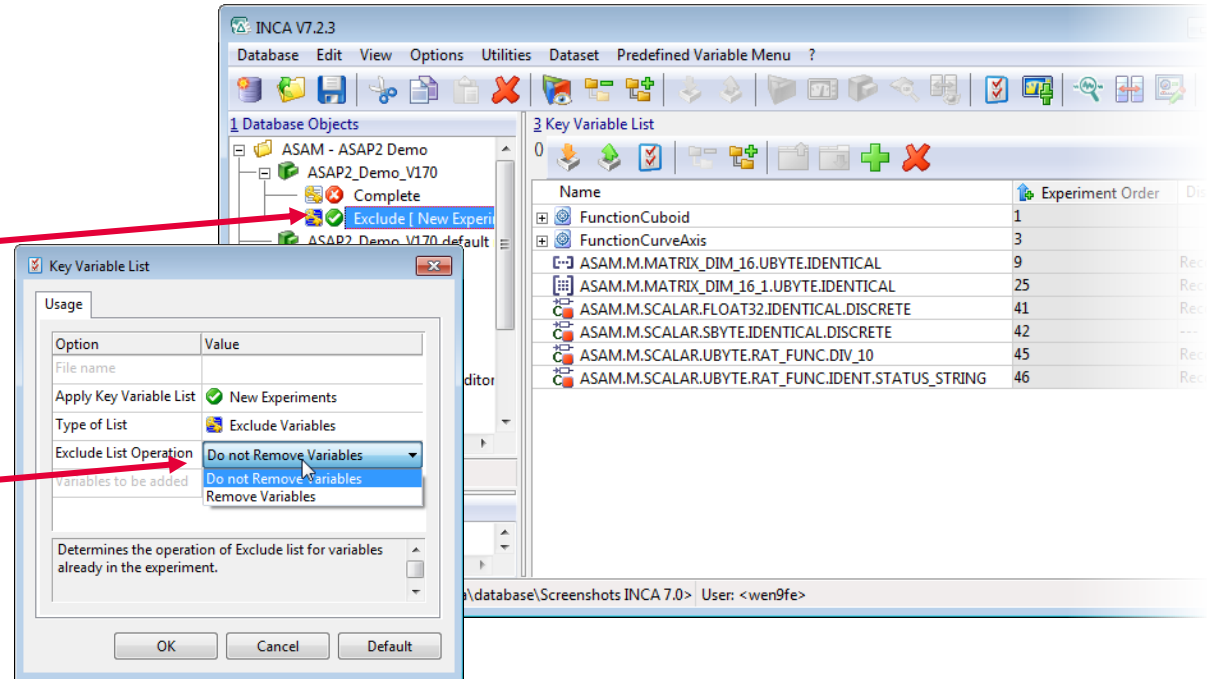

* If a Black List is active
INCA de-activates all „White List“

Available with INCA V7.2 SP3

INCA V7.2 – What's New

Functionality



MCE – Option for automatically adding EE variables to the MCE configuration

The existing menu options "Add all ... Of experiment" in the meaning from a "once executed action" are improved to a function that takes care that the variables are always added automatically.

The activation of the functionality is indicated by a check mark. The actualization of the configuration is started by the following events:

- Measurements are added with "Start Measurement"
- Parameters are added with "Switch Calibration Access On"

This allows to provide comfortable configuration for test bench and manual configuration use cases.

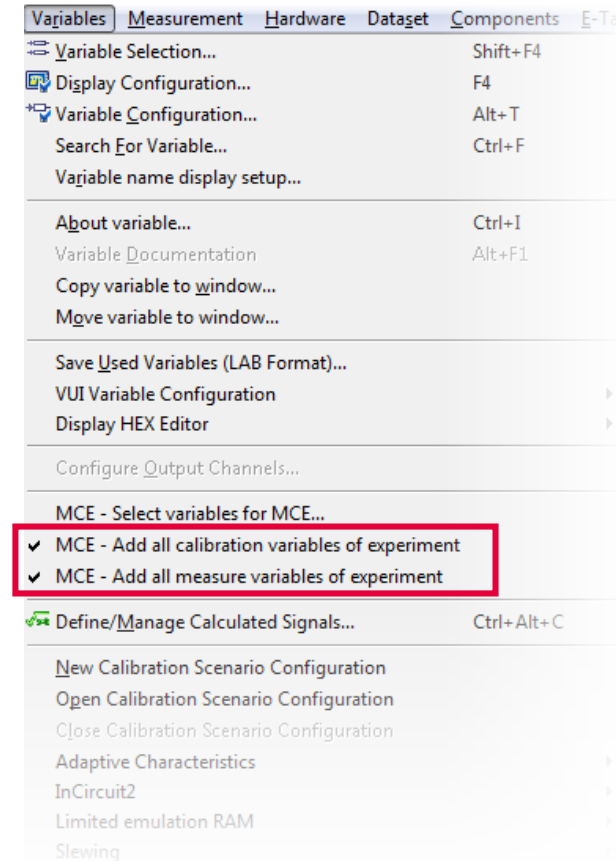

INCA V7.2 – What's New

Functionality



Monitoring of PDU based signals on Ethernet

Support of Autosar XML file based PDU Monitoring

Support of ES886 and VN5610/A

Support of UDP/IP

Support of IPv4

Support of multiplexed I-PDU's

Support of container I-PDU's

Support of secured I-PDU's

Support of E2E protection

Support of IP fragmentation

Support of signals ≤ 32 bit

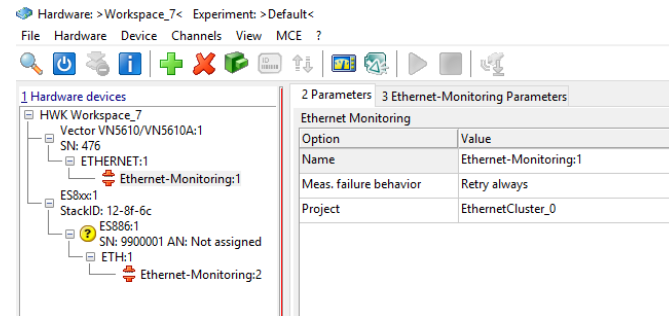
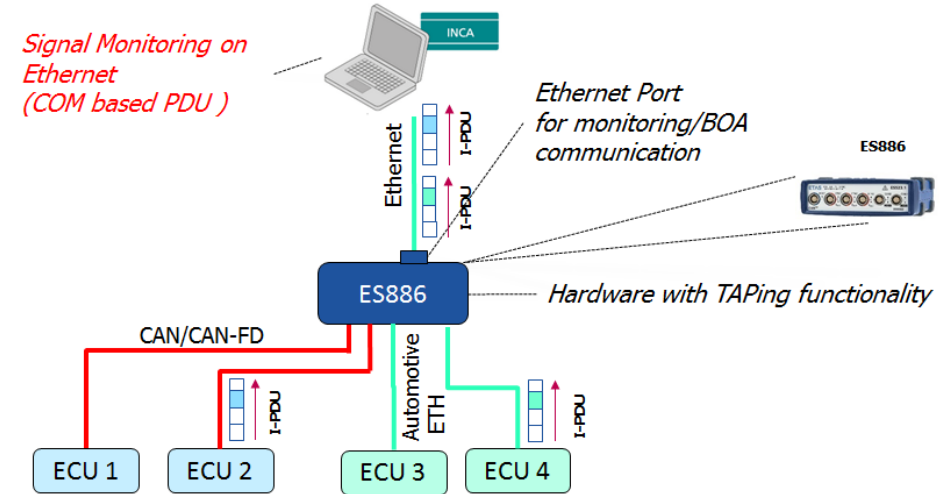

AUTOSAR Communication based PDU on all transport layers

Available with INCA V7.2 SP13

INCA V7.2 – What's New

Functionality



J1939 Monitoring

- INCA 7.2.0 supports J1939 monitoring and recording of signals placed in messages with the null (0xFE) address as source or destination.
- J1939 DBC files with messages with the null (0xFE) address can be used now with INCA 7.2.0.

INCA V7.2 – What's New

Functionality



AUTOSAR – Container I-PDU for CAN/CAN FD and FlexRay Monitoring

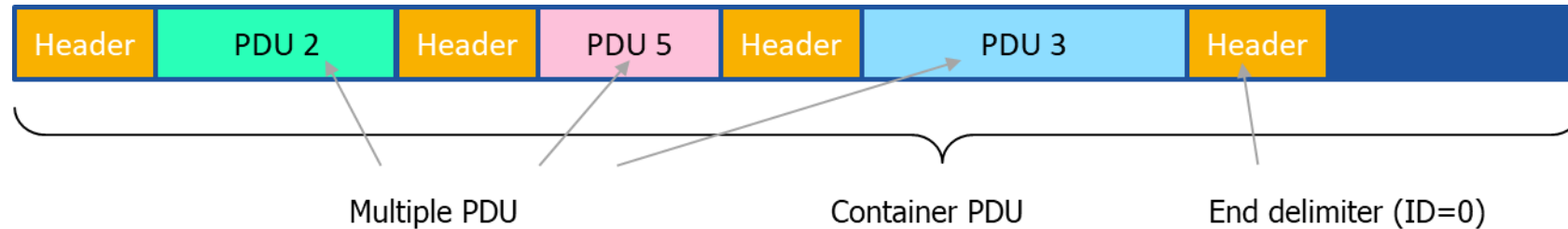

Description format

- INCA accepts description of multiple PDU to container from
- AUTOSAR v4.2.2, v4.3.0, v4.3.1.

Signals defined in more than one PDU

- INCA creates additionally to the original signal separated signals
- for each PDU with the scheme [orig-sig-name].[PDU-name]



Available with INCA V7.2 SP6 / SP9

INCA V7.2 – What's New

Functionality



AUTOSAR – Container I-PDU for CAN/CAN FD and FlexRay Monitoring

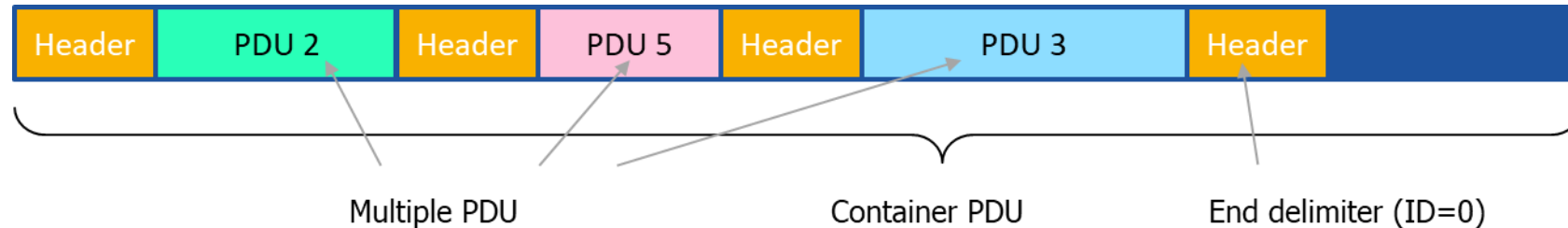

Support of NO-HEADER Keyword

- AUTOSAR v4.3.1 feature
- INCA accepts now the new header type "NO-HEADER" in addition to SHORT-HEADER and LONG-HEADER
- In consequence the PDUs have to be configured static in the Container PDU for NO-HEADER Container PDUs



Available with INCA V7.2 SP11

INCA V7.2 – What's New

Functionality



AUTOSAR – Secured I-PDU for CAN/CAN FD and FlexRay Monitoring

AUTOSAR provides the Secured Onboard Communication (SecOC) concept which are supported now with INCA 7.2 for **CAN/CAN FD and FlexRay** monitoring.

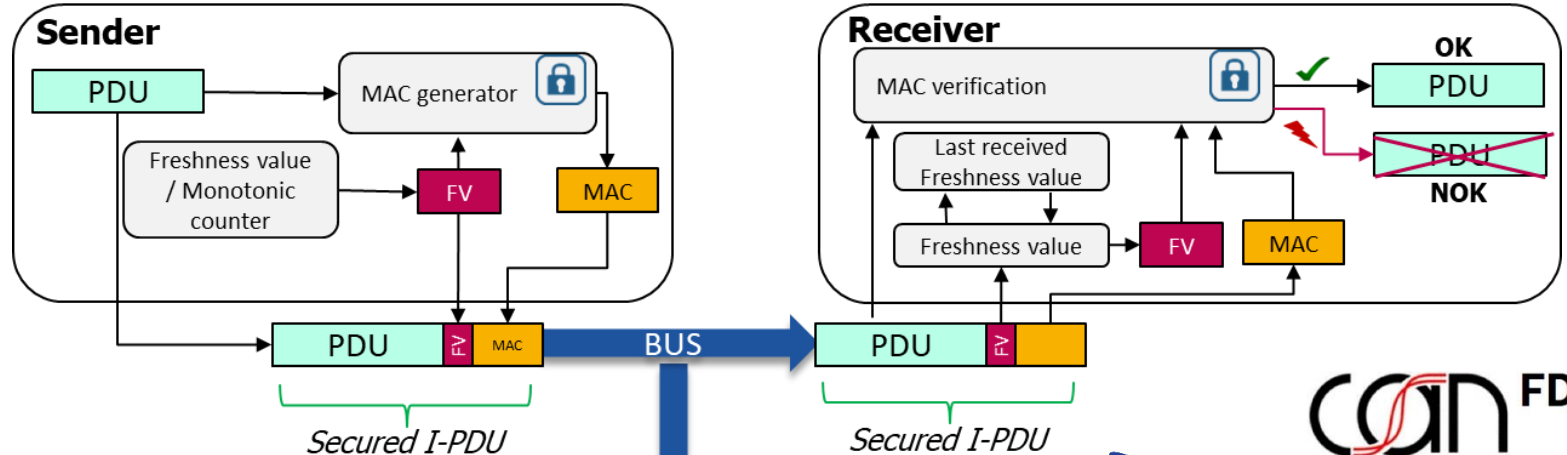

Available with [INCA V7.2 SP6](#) / [SP9](#)

INCA V7.2 – What's New

Functionality



AUTOSAR – Multiplexed-I-PDU monitoring for CAN/CAN FD and FlexRay

Signals defined in the static segments and dynamic segments of a multiplexed I-PDU can be measured in INCA using CAN/CAN FD monitoring and FlexRay monitoring. Multiplexed I-PDU is used at customer ECU communication in order to use the available bandwidth efficiently.

Example layout of an Multiplexed-I-PDU:

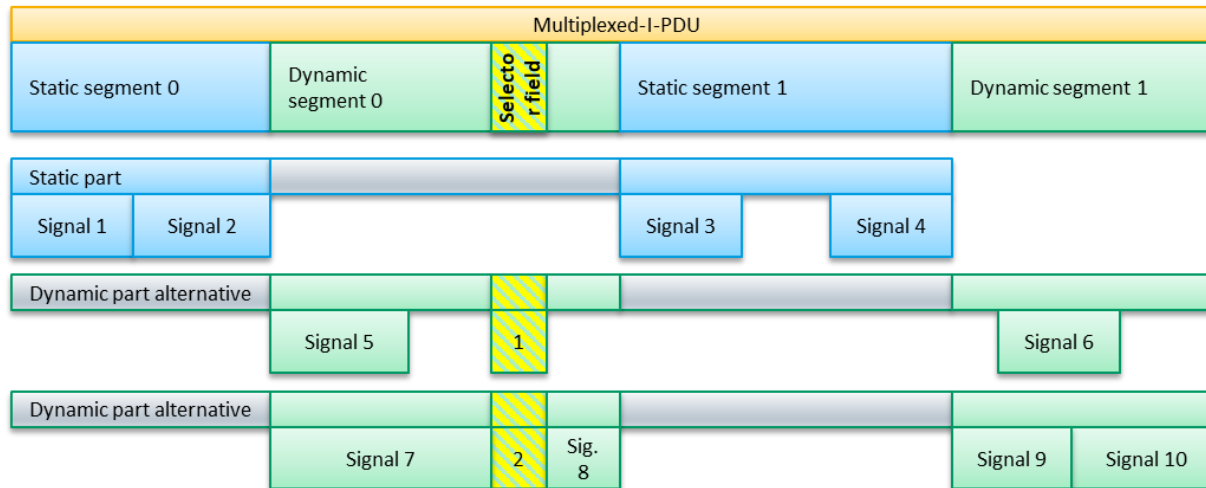

AUTOSAR
Enabling Innovation

CAN^{FD}

FlexRayTM

Available with INCA V7.2 SP8 / SP9

Note: this feature is **not supported by legacy hardware** (ES590, ES591, ES690 and ES1222)

INCA V7.2 – What's New

Functionality



AUTOSAR – End to End communication protection (E2E) for CAN/CAN FD and FlexRay Monitoring

Among the several enhancements in AUTOSAR 4.x is the addition of E2E Communication Protection. There are several defined E2E profiles, each of it implements a combination of E2E protection mechanisms such a sequence counters, data IDs and CRCs.

INCA reads out and interprets the values from the PDU with E2E definition. The following requirements are considered:

- INCA manages user data and PDU data for selected measurement signals.
- All measurement signals of the E2E protection are visible in VSD and available for measurement and recording.



[Available with INCA V7.2 SP8 / SP9](#)



AUTOSAR – Update Bit support for CAN/CAN FD/FlexRay

The Update-Bit in a frame indicates if the sender of the frame has updated the data in the signal/signal groups/PDUs of the frame before sending.

INCA now evaluates the update bit during CAN/CAN-FD/Flexray monitoring and only updates the corresponding signal data in the Experiment and recording file, if the update bit is set to 1.

In addition, the update bit itself is available as measurement signal in the VSD.

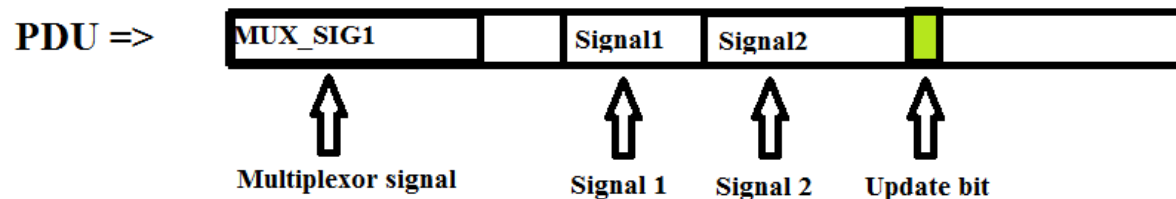

Available with INCA V7.2 SP10

INCA V7.2 – What's New

Functionality



AUTOSAR – Show full Path of Cluster to identify ARXML File in the Workspace

Additionally to the assigned cluster (project) of a bus monitoring device also the associated AUTOSAR container is shown in the workspace of DBB

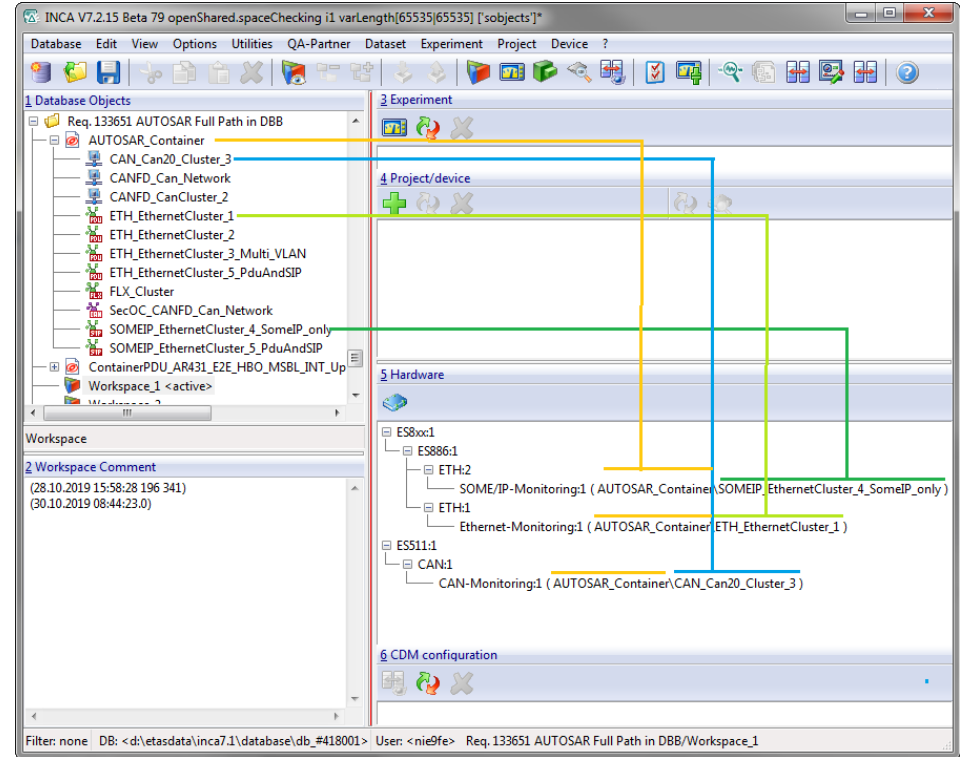

Available with INCA V7.2 SP15



UDS on FlexRay flashing – Support sending functional requests

Up to now, the configuration of the FlexRay transport layer for UDS on FlexRay flashing with PROF was only possible by extracting all required parameters from a Fibex file.

In case the customer Fibex file misses some parameters (e.g. for sending a functional request) or contained wrong parameters, flashing was not possible.

PROF now supports to configure the FlexRay Transport layer with new PROF CNF parameters, thus becoming independent from incomplete or erroneous customer Fibex files.

The new CNF parameters also support to configure a functional ID for sending, e.g. for sending functional requests (customer use case that triggered the feature).

Hints:

PROF does not allow to receive responses on a functional request! Only the sending is supported!

The new CNF parameters and how to use them is documented in the updated PROF documentation.

[Available with INCA V7.2 SP7](#)



UDS on FlexRay – ISO FlexRay TP

- INCA-ProF supports UDS on FLX flashing according to AUDI-TP since INCA 7.1.3
- INCA-ProF now also supports UDS on FLX flashing according to ISO10681-2 (ISO-TP)
- The TP variant to be used has to be defined in the .cnf file of the ProF configuration:
 - AUDI-TP: `TRANSPORT_PROTOCOL_VERSION:, 0x01;`
 - ISO-TP: `TRANSPORT_PROTOCOL_VERSION:, 0x02;`
- Limitations: The following ISO10681-2 features are currently not supported:
 - No support for dynamic bandwidth adaptation (only static configuration)
 - No support for acknowledgements with retry transmission
 - No support for unknown message lengths

[Available with INCA V7.2 SP15](#)

INCA V7.2 – What's New

Functionality



ASAP3 – Make "MeasureTimeoutEquidistantdtMaxValue" configurable

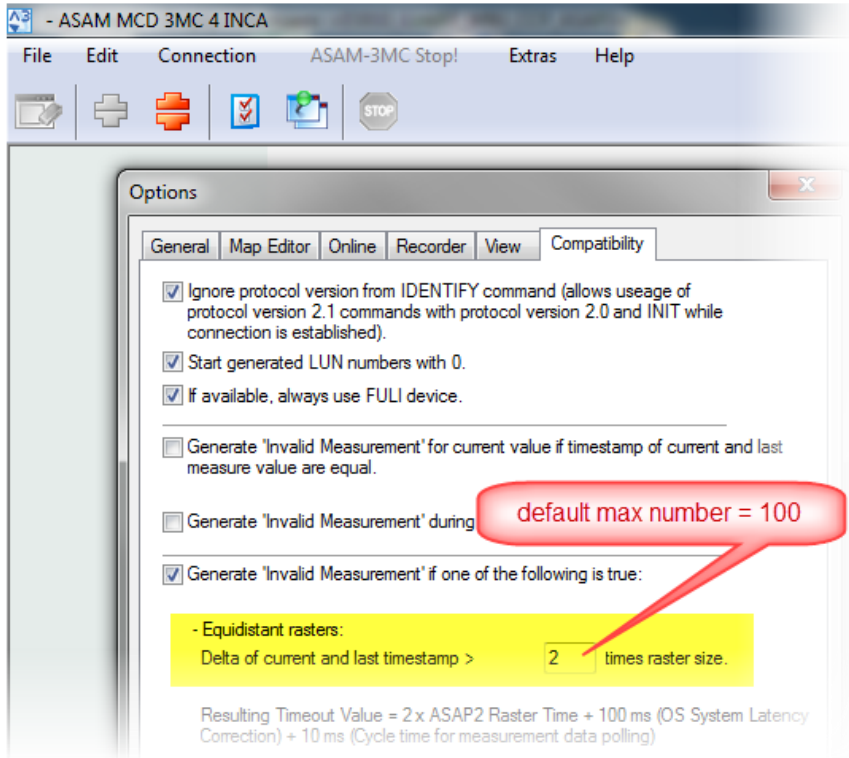

For low-frequent Signals it is necessary to have a more flexible configuration of time out parameters.

- Now values up to 2.147.483.647 (32-Bit Integer) are possible
- The default of 100 remains

INCA V7.2 – What's New

Functionality



ASAP3 – Support of Extended Commands

ASAP3 Commands supported additionally:

- "EXTENDED PARAMETER FOR VALUE ACQUISITION"
- "EXTENDED GET ONLINE VALUE"

- These command allow to handle the parameter values data type dependent

- By this it is possible to transfer FLOAT32 or FLOAT64 values *)

*) Note: Data type STRING is not supported



ASAP3 – Get & Set INCA Options / Get State

Scripts running on a testbench may check / modify INCA options. ASAP3 and the COM-API support now access to the following options / states

Options (read / write)

- MCE: AddAllMeasurements
- MCE: AddAllCalibrations
- ASAP3: AddAutomaticallyToFuliDevice
- HWC: Measurement failure behavior *)
- HWC: Connection behavior *)

States (read only)

- EXPERIMENT: ConnectionInterruptBehavior
- HWC: GetDifferenceCounter
- HWC: CheckOfState
- HWC: BaudRate
- MEMORYPAGE: EPK (Eprom Kennung)
- MEMORYPAGE: Checksum

*) HWC supports only read access

[Available with INCA V7.2 SP3](#)

INCA V7.2 – What's New

Functionality



INCA Options – GET / SET via COM API or ASAP3

The INCA COM API supports GET and SET commands to access options.

The INCA ASAP3 server supports the GetOption and SetOption by ASAP3 EXTENDED SERVICES

The detailed list of options that can be read / write is stated in the INCA CEBRA documentation that is part of the INCA installation.

[Available with INCA V7.2 SP6](#)

INCA V7.2 – What's New

Functionality



ASAP3 – Read Data Exchange File in EE

The ASAP3 client needs to update a data set with a dedicated list of parameter values.

The INCA ASAP3 server supports an ASAP3 EXTENDED SERVICE to tell INCA the name and path of a data exchange file that INCA shall copy to the current working page.

- The path can be a local or network path
- INCA respects the current copy settings
- INCA supports read / write of the copy settings via ASAP3

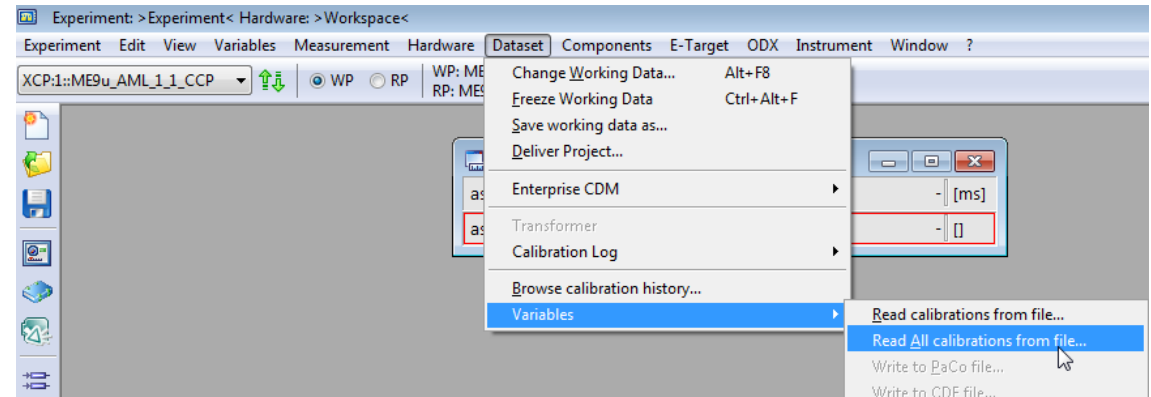

Same functionality like INCA offers in the Experiment

Also available via INCA COM API

Available with INCA V7.2 SP6

INCA V7.2 – What's New

Functionality



CAN / CAN FD Monitor – Improvement on the DLC validation

Existing validation of the data length code (DLC) has been improved in INCA 7.2.0 to allow measurement and recording, even if the DLC defined in DBC file is larger than active frame size on the bus.

Example use case:

CAN/CAN-FD frame defined in DBC file: 8 Bytes length and for signals 1 to 8 (1 byte per signal)

Byte 0	Byte 1	Byte 2	Byte 3	Byte 4	Byte 5	Byte 6	Byte 7
Sig1	Sig2	Sig3	Sig4	Sig5	Sig6	Sig7	Sig8

User uses in INCA experiment only Sig1 and Sig2 for recording/measurement:

DLC on the BUS = 2 bytes

Byte 0	Byte 1	Byte 2	Byte 3	Byte 4	Byte 5	Byte 6	Byte 7
Sig1	Sig2						

NOTE: This feature has not been implemented for legacy devices like ES590, ES591, ES690 and ES1222.

INCA V7.2 – What's New

Functionality



CAN-FD – Message Sending

CAN-FD allows messages with a length of up to 64 bytes.

The new INCA message editor allows to define messages with a variable length.

- Columns for setting message type (FD or non-FD)
- Up to 64 bytes as data
- Column "DLC" renamed to "Size"
- Copy & Paste now allows exchange with Windows Clipboard

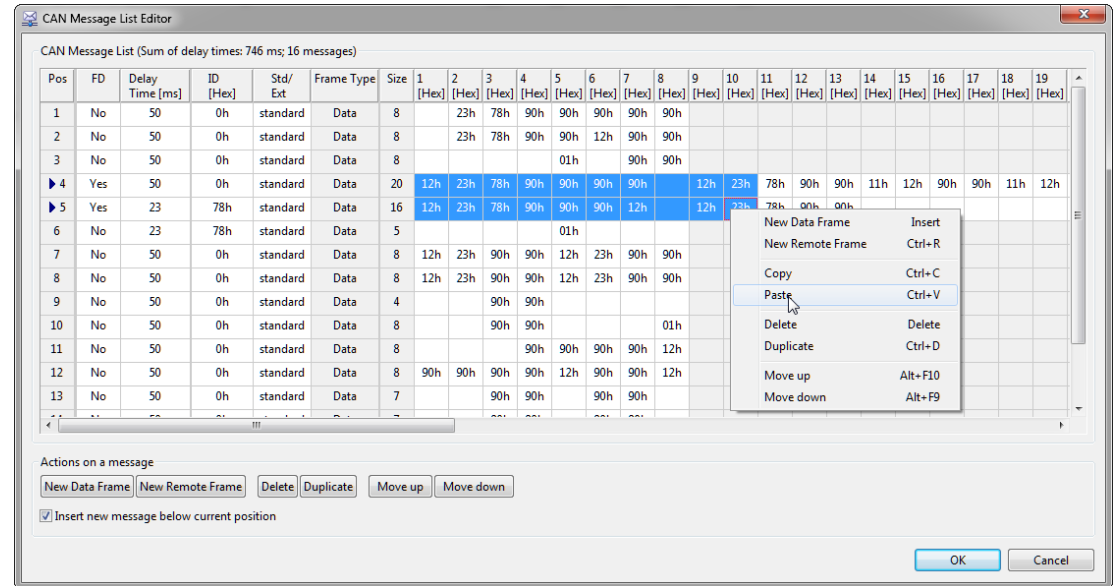

Available with INCA V7.2 SP10

INCA V7.2 – What's New

Functionality



IP Manager

Default IP address range for the IP assignation of the ETAS hardware

To avoid IP address conflict with 3rd party hardware, the INCA user can define default IP address range, which should be used for the IP address assignation of ETAS HW. The default IP range parameters can be defined in the InstallationDefaultSettings.xml file of the INCA 7.2.0 installation as follows.

Example:

```
<Package displayName="BIP-IP_Manager.Shared" ID="ETAS.MCD.INCA IP_Manager.Shared_7.2.0.251">
  - <CustomParameters>
    <Variable validation="none" defaultValue="true" name="IPM_AUTO_CONFIG_NIC"/>
    <Variable validation="none" defaultValue="true" name="IPM_AUTO_IP_RANGE"/>
    <Variable validation="none" defaultValue="15" name="IPM_DEFAULT_OFFSET_START"/>
    <Variable validation="none" defaultValue="200" name="IPM_DEFAULT_OFFSET_END"/>
  </CustomParameters>
</Package>
```

These parameters will be used for the ETAS Network settings as default. According to the example above, if the user has the 192.168.40.15, the IP Manager will assign the 192.168.40.200 to the first ETAS HW.

INCA V7.2 – What's New

Functionality



Resolution of IP address conflict of ETAS HW

IP address conflict of ETAS hardware can be now solved by one mouse click. User is able to reassign or to reset static IP address configuration of ETAS devices with the same IP address.

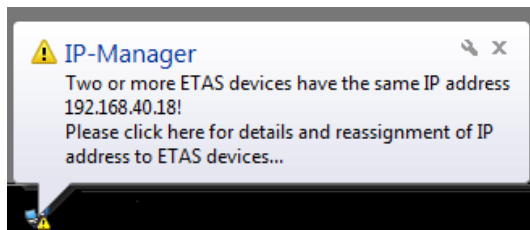

Automatic detection of IP conflict
User is informed about issue

Click over
balloon text



Select device
and click on
"Reassign
selected" button

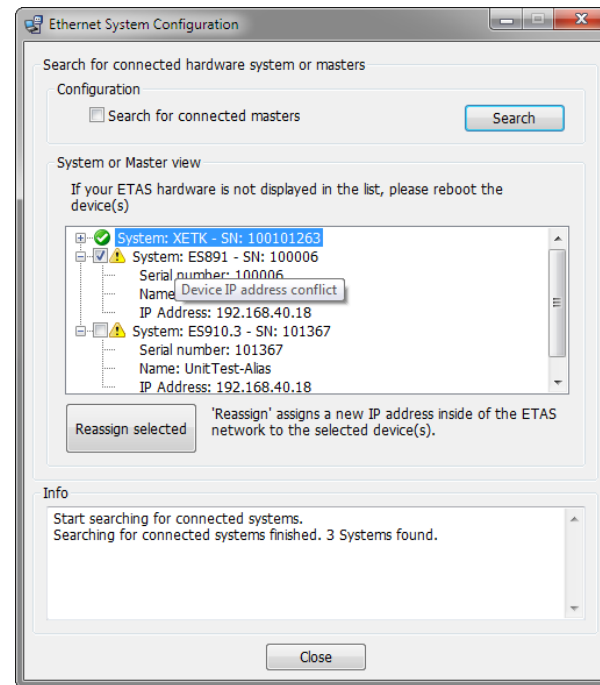

Available with INCA V7.2 SP2

INCA V7.2 – What's New

Functionality



Improvement of search for hardware (SFH) functionality

Search For Hardware dialog has been improved to increase the effectivity by searching for desired hardware interfaces.

For Ethernet and USB hardware the search time is now up to 8 times better

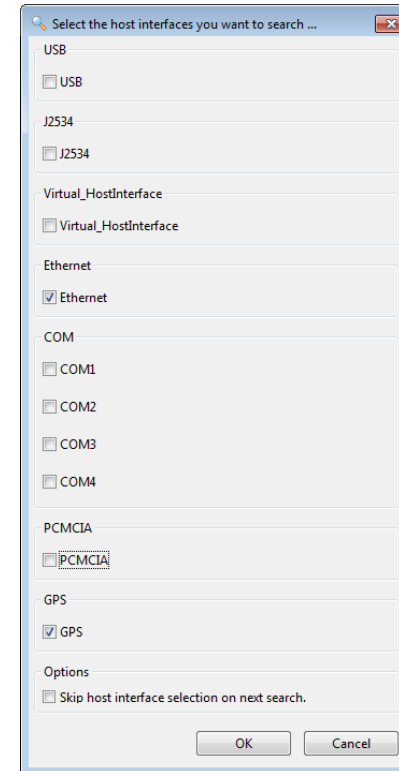

Available with INCA V7.2 SP6

INCA V7.2 – What's New

Functionality



CDM – Inline Compare

To see the difference between two data sets CDM supports a special Inline View

Mark the destination by the context menu

Activate the inline editor in the CDM options

The selected parameter is shown with Inline Compare

Upper line is source, lower line is selected destination

The screenshot shows the INCA CDM software interface. The 'Comparison source' is '[Demo08\Demo08_8] CDM|E| ...' and the 'Comparing destination' is '[Demo08\Demo08_7] CD 1'. The 'Action' is 'Compare' and the 'Format' is 'HTML'. The 'Variables & functions to process' list includes DEMO_CUBE_4_1, DEMO_CUBOID_1, DEMO_CUBOID_2, DEMO_CURVE, DEMO_CURVE_2, DEMO_CURVE_3, and DEMO_CURVE_4. The 'Inline Compare' view for DEMO_CURVE_2 is shown, displaying a table of values for x, y, and z coordinates. The table has 3 rows and 8 columns. The first row is the source (upper line) and the second row is the selected destination (lower line). The values are: x: 120, 520, 720, 1120, 5840, 7160, 7760; y: 120, 520, 840, 1120, 1360, 1600, 2000; z: 0.0039, 0.1055, 0.2188, 0.2539, 0.4219, 0.1211, 0.4922. The second row of the z values is highlighted in red.

	120	520	720	1120	5840	7160	7760
x	120	520	720	1120	5840	7160	7760
y	120	520	840	1120	1360	1600	2000
z	0.0039	0.1055	0.2188	0.2539	0.4219	0.1211	0.4922
z	0.0039	0.1055	0.1055	0.2539	0.4219	0.3086	0.4922

Available with INCA V7.2 SP11

INCA V7.2 – What's New

Functionality



CDM – Multi Column View

- Switch between Source and Multi Column view
- All data sets have own column
- Source data set is marked with yellow background
- Destinations show individual instant compare against source
- Source shows instant compare overall data sets
- Inline Compare of single values between source and destination
- Function / Group compare

CDM - ASAP2_Demo_MultiColumn - D:\info\ASAM\MCD-ZMC V1.7.0\ASAP2 Example File\CDM.CDFX

File Datasets Variables Actions Options View ?

List source: [ASAP2_Demo_V170\ASAP2_Demo_V170] ...

Active Dataset: [ASAP2_Demo_V161\ASAP2_Demo_V161] ...

Variables & functions to process: 9/9 64/72

Function	[ASAP2_Demo_V170_1] ASAP2_V161	[ASAP2_Demo_V161] ASAP2_V161	ASAP2_Demo_V170	ASAP2_V161	[ASAP2_Demo_V161_1] ASAP2_V161	[ASAP2_Demo_V161.cdfx]
FunctionCuboid	ASAM.C.CUBOID.COM_AXIS.FIX_AXIS.STD_AXIS	ASAM.C.CUBOID.COM_AXIS.FIX_AXIS.STD_AXIS	ASAM.C.CUBOID.COM_AXIS.FIX_AXIS.STD_AXIS	ASAM.C.CUBOID.COM_AXIS.FIX_AXIS.STD_AXIS	ASAM.C.CUBOID.COM_AXIS.FIX_AXIS.STD_AXIS	ASAM.C.CUBOID.COM_AXIS.FIX_AXIS.STD_AXIS
FunctionCurve	ASAM.C.CURVE.CURVE_AXIS	ASAM.C.CURVE.CURVE_AXIS	ASAM.C.CURVE.CURVE_AXIS	ASAM.C.CURVE.CURVE_AXIS	ASAM.C.CURVE.CURVE_AXIS	ASAM.C.CURVE.CURVE_AXIS
FunctionMap	ASAM.C.MAP.COM_AXIS.FIX_AXIS	ASAM.C.MAP.COM_AXIS.FIX_AXIS	ASAM.C.MAP.COM_AXIS.FIX_AXIS	ASAM.C.MAP.COM_AXIS.FIX_AXIS	ASAM.C.MAP.COM_AXIS.FIX_AXIS	ASAM.C.MAP.COM_AXIS.FIX_AXIS
FunctionScalar	ASAM.C.SCALAR.FLOAT32_IEEE.IDENTICAL	ASAM.C.SCALAR.FLOAT32_IEEE.IDENTICAL	ASAM.C.SCALAR.FLOAT32_IEEE.IDENTICAL	ASAM.C.SCALAR.FLOAT32_IEEE.IDENTICAL	ASAM.C.SCALAR.FLOAT32_IEEE.IDENTICAL	ASAM.C.SCALAR.FLOAT32_IEEE.IDENTICAL
ASAM.C.SCALAR.FLOAT64_IEEE.IDENTICAL	ASAM.C.SCALAR.FLOAT64_IEEE.IDENTICAL	ASAM.C.SCALAR.FLOAT64_IEEE.IDENTICAL	ASAM.C.SCALAR.FLOAT64_IEEE.IDENTICAL	ASAM.C.SCALAR.FLOAT64_IEEE.IDENTICAL	ASAM.C.SCALAR.FLOAT64_IEEE.IDENTICAL	ASAM.C.SCALAR.FLOAT64_IEEE.IDENTICAL
ASAM.C.SCALAR.SBYTE.IDENTICAL	ASAM.C.SCALAR.SBYTE.IDENTICAL	ASAM.C.SCALAR.SBYTE.IDENTICAL	ASAM.C.SCALAR.SBYTE.IDENTICAL	ASAM.C.SCALAR.SBYTE.IDENTICAL	ASAM.C.SCALAR.SBYTE.IDENTICAL	ASAM.C.SCALAR.SBYTE.IDENTICAL
ASAM.C.SCALAR.SLONG.IDENTICAL	ASAM.C.SCALAR.SLONG.IDENTICAL	ASAM.C.SCALAR.SLONG.IDENTICAL	ASAM.C.SCALAR.SLONG.IDENTICAL	ASAM.C.SCALAR.SLONG.IDENTICAL	ASAM.C.SCALAR.SLONG.IDENTICAL	ASAM.C.SCALAR.SLONG.IDENTICAL
ASAM.C.SCALAR.SWORD.FORM_X_PLUS_4	ASAM.C.SCALAR.SWORD.FORM_X_PLUS_4	ASAM.C.SCALAR.SWORD.FORM_X_PLUS_4	ASAM.C.SCALAR.SWORD.FORM_X_PLUS_4	ASAM.C.SCALAR.SWORD.FORM_X_PLUS_4	ASAM.C.SCALAR.SWORD.FORM_X_PLUS_4	ASAM.C.SCALAR.SWORD.FORM_X_PLUS_4
ASAM.C.SCALAR.SWORD.IDENTICAL	ASAM.C.SCALAR.SWORD.IDENTICAL	ASAM.C.SCALAR.SWORD.IDENTICAL	ASAM.C.SCALAR.SWORD.IDENTICAL	ASAM.C.SCALAR.SWORD.IDENTICAL	ASAM.C.SCALAR.SWORD.IDENTICAL	ASAM.C.SCALAR.SWORD.IDENTICAL
ASAM.C.SCALAR.SWORD.LINEAR_MUL_2	ASAM.C.SCALAR.SWORD.LINEAR_MUL_2	ASAM.C.SCALAR.SWORD.LINEAR_MUL_2	ASAM.C.SCALAR.SWORD.LINEAR_MUL_2	ASAM.C.SCALAR.SWORD.LINEAR_MUL_2	ASAM.C.SCALAR.SWORD.LINEAR_MUL_2	ASAM.C.SCALAR.SWORD.LINEAR_MUL_2
ASAM.C.SCALAR.SWORD.RAT_FUNC_DIV_10	ASAM.C.SCALAR.SWORD.RAT_FUNC_DIV_10	ASAM.C.SCALAR.SWORD.RAT_FUNC_DIV_10	ASAM.C.SCALAR.SWORD.RAT_FUNC_DIV_10	ASAM.C.SCALAR.SWORD.RAT_FUNC_DIV_10	ASAM.C.SCALAR.SWORD.RAT_FUNC_DIV_10	ASAM.C.SCALAR.SWORD.RAT_FUNC_DIV_10
ASAM.C.SCALAR.SWORD.RAT_FUNC_DIV_81_9175	ASAM.C.SCALAR.SWORD.RAT_FUNC_DIV_81_9175	ASAM.C.SCALAR.SWORD.RAT_FUNC_DIV_81_9175	ASAM.C.SCALAR.SWORD.RAT_FUNC_DIV_81_9175	ASAM.C.SCALAR.SWORD.RAT_FUNC_DIV_81_9175	ASAM.C.SCALAR.SWORD.RAT_FUNC_DIV_81_9175	ASAM.C.SCALAR.SWORD.RAT_FUNC_DIV_81_9175
ASAM.C.SCALAR.SWORD.TAB_INT_P_DEFAULT_VALUE	ASAM.C.SCALAR.SWORD.TAB_INT_P_DEFAULT_VALUE	ASAM.C.SCALAR.SWORD.TAB_INT_P_DEFAULT_VALUE	ASAM.C.SCALAR.SWORD.TAB_INT_P_DEFAULT_VALUE	ASAM.C.SCALAR.SWORD.TAB_INT_P_DEFAULT_VALUE	ASAM.C.SCALAR.SWORD.TAB_INT_P_DEFAULT_VALUE	ASAM.C.SCALAR.SWORD.TAB_INT_P_DEFAULT_VALUE

Results: 0 Errors, 0 Warnings, 0/0 Different items (Functions/v Output file), 0/0 Missing items (Functions/v View)

Start action: \$[EcuProjectPath]

Comparison background completed.

Available with INCA V7.2 SP14

INCA V7.2 – What's New

Functionality



CDM – Write data exchange file for Groups separately

To distribute information to different locations it is now possible to get separated files for each GROUP or FUNCTION.

If the CDM option 'Generate output file' is set to 'one output list for each function' CDM creates separated files.

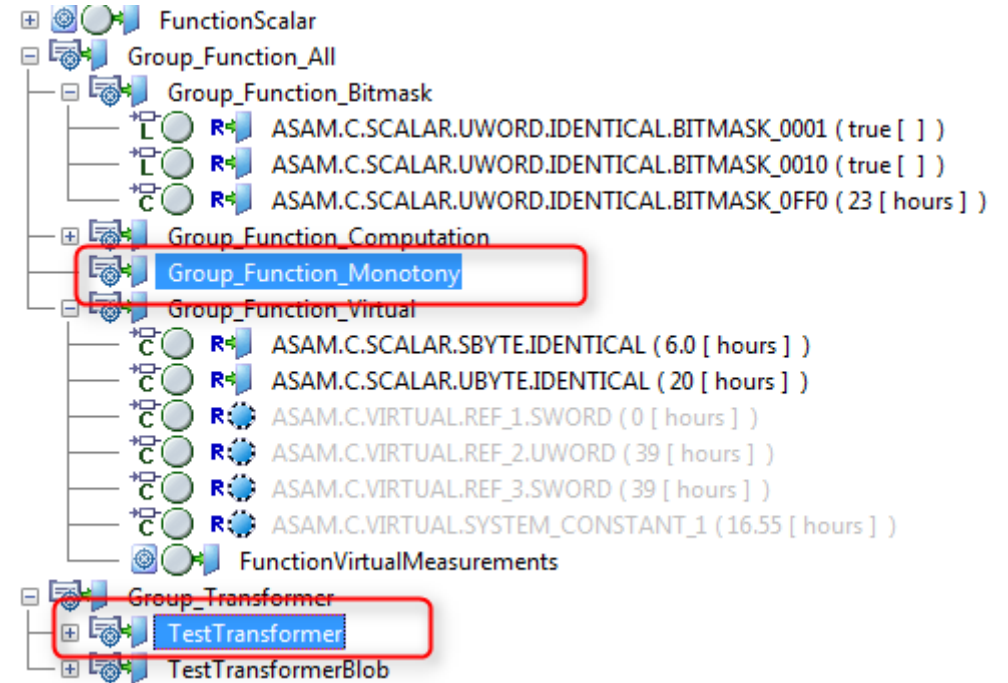

Available with INCA V7.2 SP15

INCA V7.2 – What's New

Functionality



Allow search in "Add hardware device" dialog

INCA offers a wide range of hardware devices. To easily find hardware the Add Hardware Device dialog offers a search functionality.

- The user is able to type in the search text in the search field
- INCA expands the nodes where the hardware is found

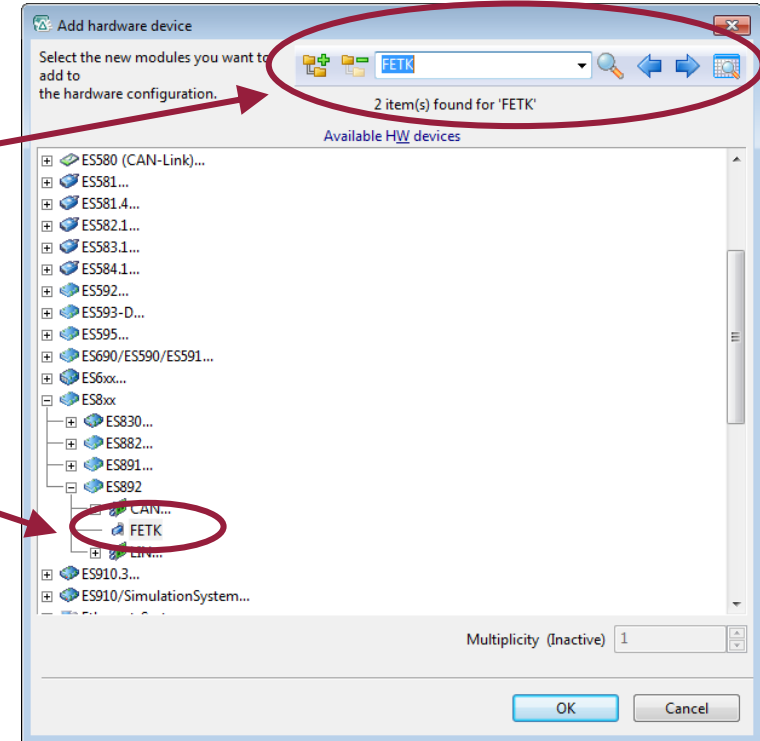

Available with INCA V7.2 SP8

INCA V7.2 – What's New

Functionality



Disable search for J2534 hardware

The user can disable search for J2534 hardware devices in order to avoid pop-up dialogs of 3rd party J2534 hardware.

Default value of this new user option can be defined also in the INCA INI file.

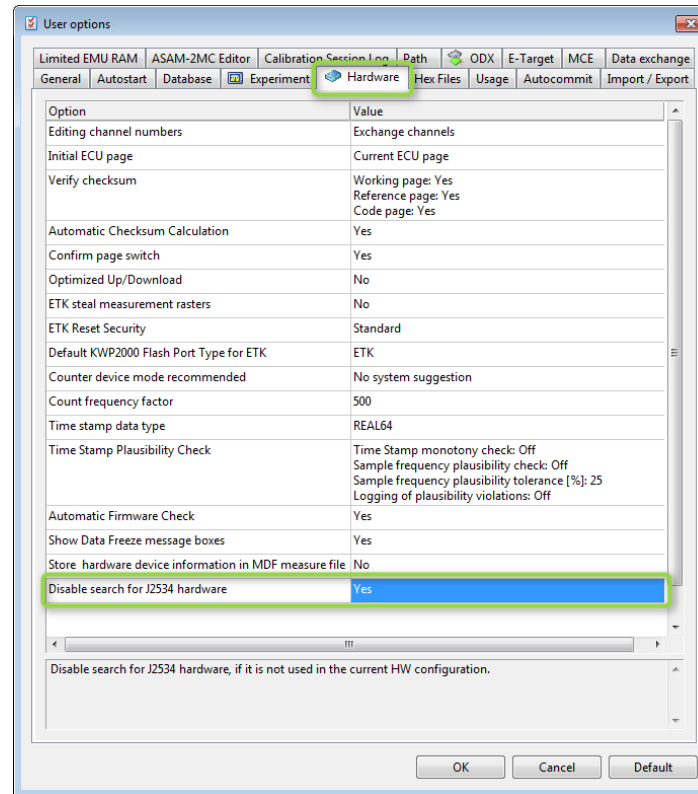

Available with INCA V7.2 SP6

INCA V7.2 – What's New

Functionality



FETK – Support of Alias Name

For a better detection and configuration INCA supports for FETK the Alias Name

- Better support of usage of multiple FETKs
- Assigning the right project files during search for hardware
- Checking if ECU is connected to the configured port
- Better visualization in different dialogs which FETK is affected by the action

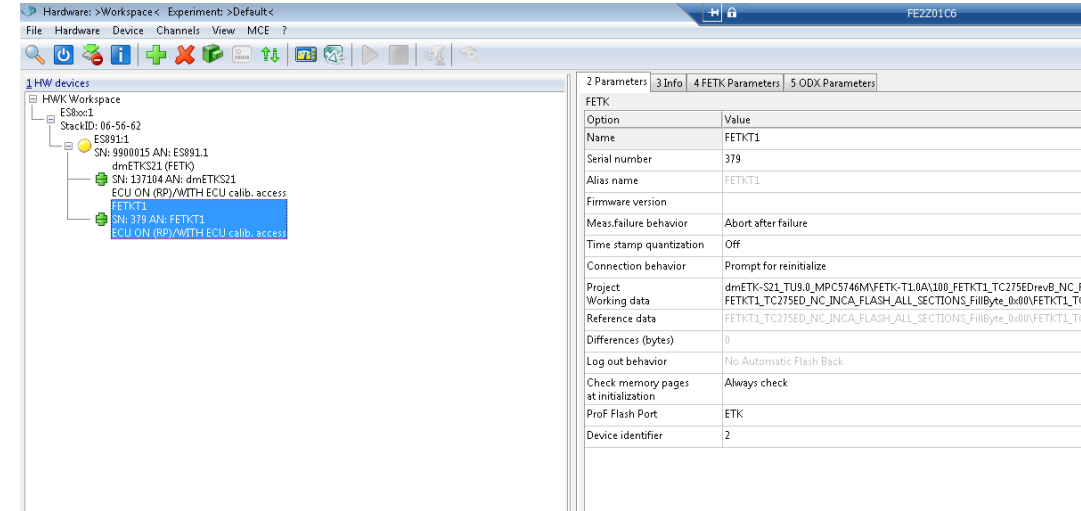

FETK mapping is not yet supported

[Available with INCA V7.2 SP11](#)

INCA V7.2 – What's New

Functionality



FETK – Mapping by Serial Number and Alias Name

For a better support of FETK INCA now tries to map the found FETK with the configured ones in the HWC by alias name and serial number.

This functionality will work only within a single ES891 for the two FETK ports.

Mapping between stacks and multiple ES891 in a stack would require a reconfiguration of the devices in the HWC and is still under discussion.

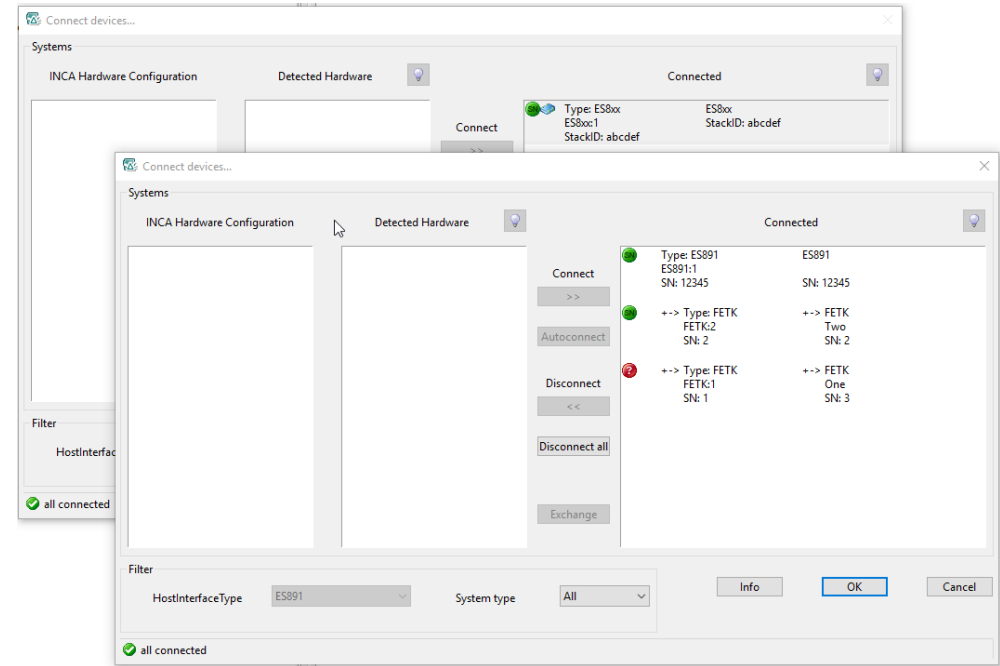

Available with INCA V7.2 SP12

INCA V7.2 – What's New

Functionality



USB Devices ES582/ES584 – Support of Alias Name

For a better detection and configuration INCA supports for ES582/ES584 the Alias Name

- Better support of usage of multiple ES582/ES584
- assigning the right project files during search for hardware
- checking if ECU is connected to the configured device
- better visualization in different dialogs which device is affected by the action

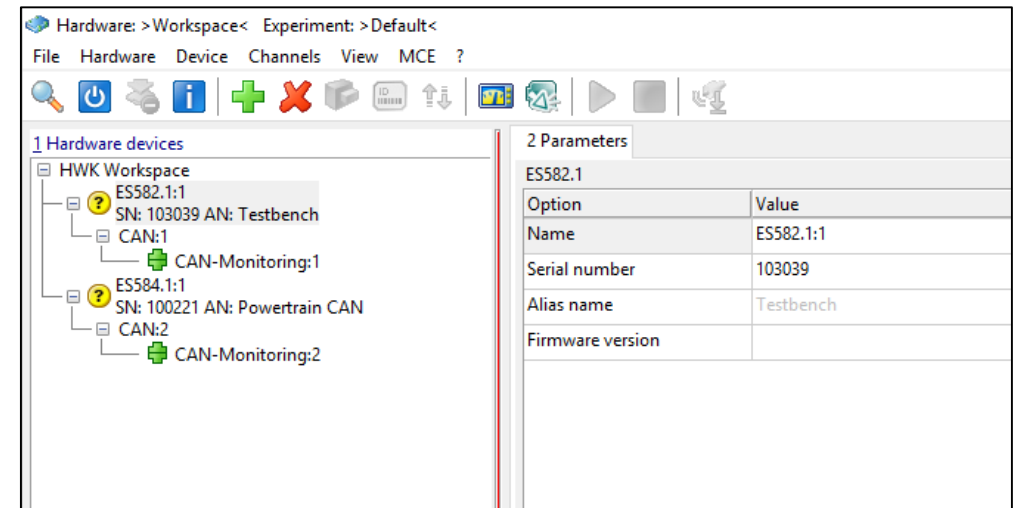

Alias Name is not supported by ES583.1 and ES581.x

[Available with INCA V7.2 SP11](#)

INCA V7.2 – What's New

Functionality

HWC – Up to 20 XCP on Ethernet slaves

The number of configurable XCP on Ethernet devices was limited to 4.

The maximum number of configurable devices was set to 20.

Hint: With more devices in parallel the bandwidth could become more and more the bottleneck in the communication.

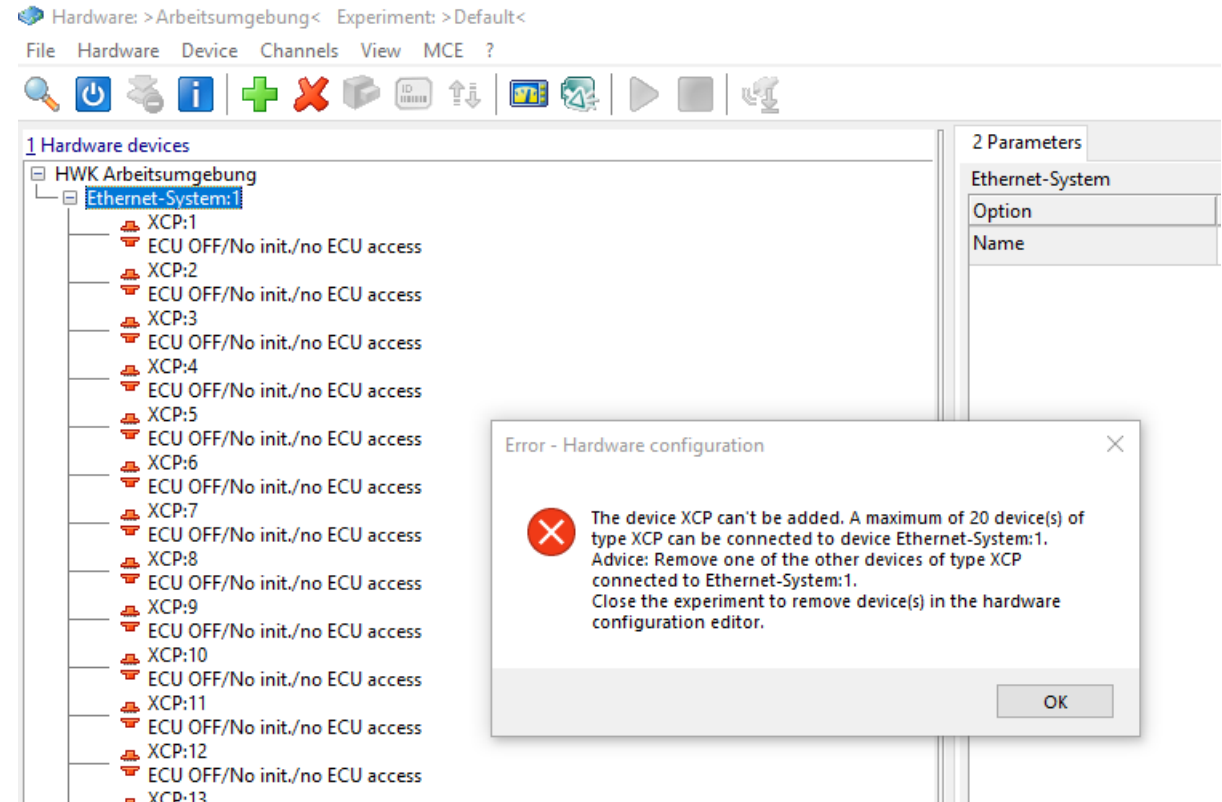

Available with INCA V7.2 SP12

INCA V7.2 – What's New

Functionality

INCA – Enhancements for writing of XDA files

For oscilloscopes INCA enters additional settings into xda configuration file.
MDA V7 and MDA V8 use this configuration file to recreate a comparable view of the oscilloscope.
Thus for users the effort to reconfigure the layout is minimized.

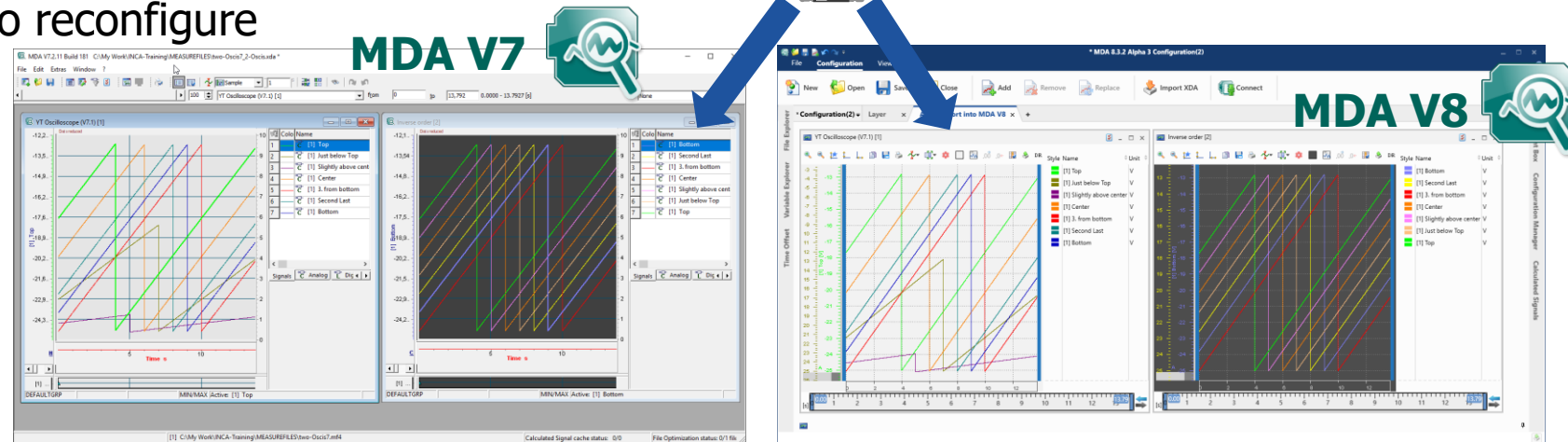
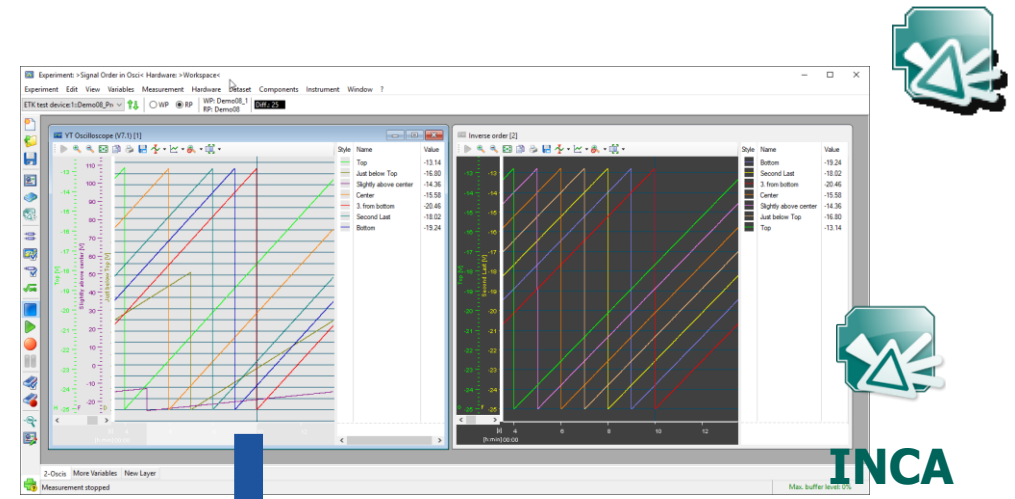

Available with INCA V7.2 SP12

INCA V7.2 – What's New

Functionality



Exchange recorder configuration

The off and on trigger configurations are split
User can set different durations for on and off trigger
Complete trigger configuration can be exported and imported

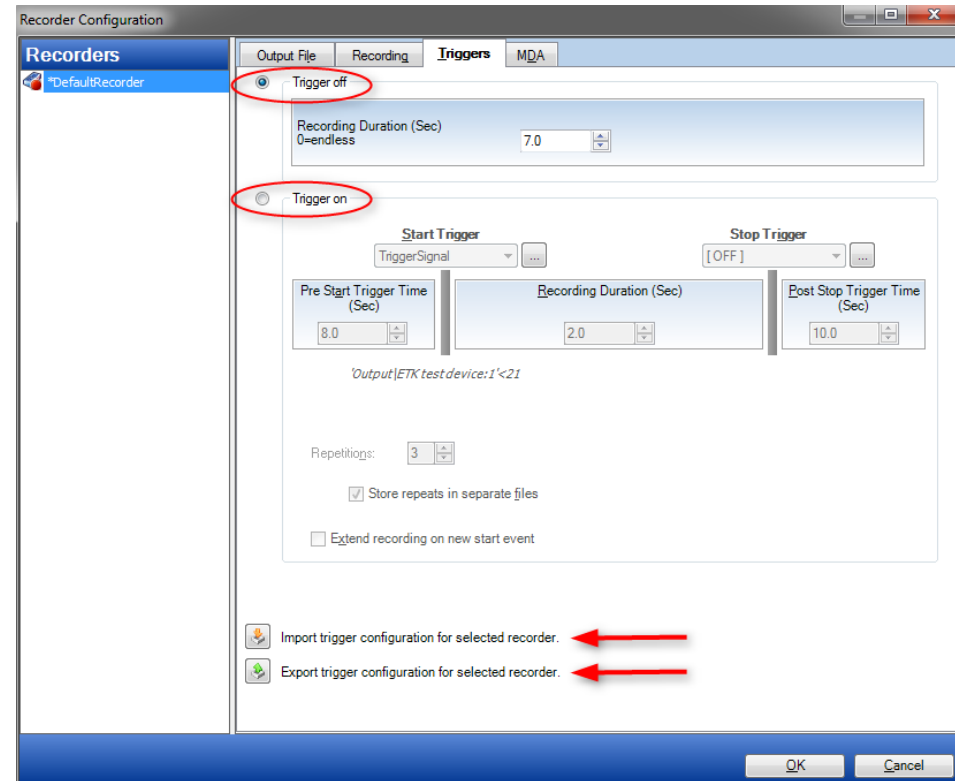

Available with INCA V7.2 SP2

INCA V7.2 – What's New

Functionality



Recorder – Variables for Output Path

In the recorder configuration the path may contain text and variables mixed

Option	Value
MDF user name (preset)	MyName
MDF company name (preset)	ETAS
MDF project name (preset)	MyProject
MDF vehicle name (preset)	MyVehicle

INCA inserts the variable values in the path

Property	Value
Path:	D:\ETASData\INCA7.2\Measure\
File:	measure_ETAS_Test Project.mf4

Supported variables:

- &[COMPANY]
- &[USER]
- &[PROJECT]
- &[VEHICLE]
- &[DATABASE]
- &[EXPERIMENT]
- &[PROGRAMDESCRIPTION]
- &[WORKSPACE]
- &[WORKINGPAGE]
- &[REFERENCEPAGE]

Available with INCA V7.2 SP7

INCA V7.2 – What's New

Functionality



Recording – Open MDA V8 from INCA EE

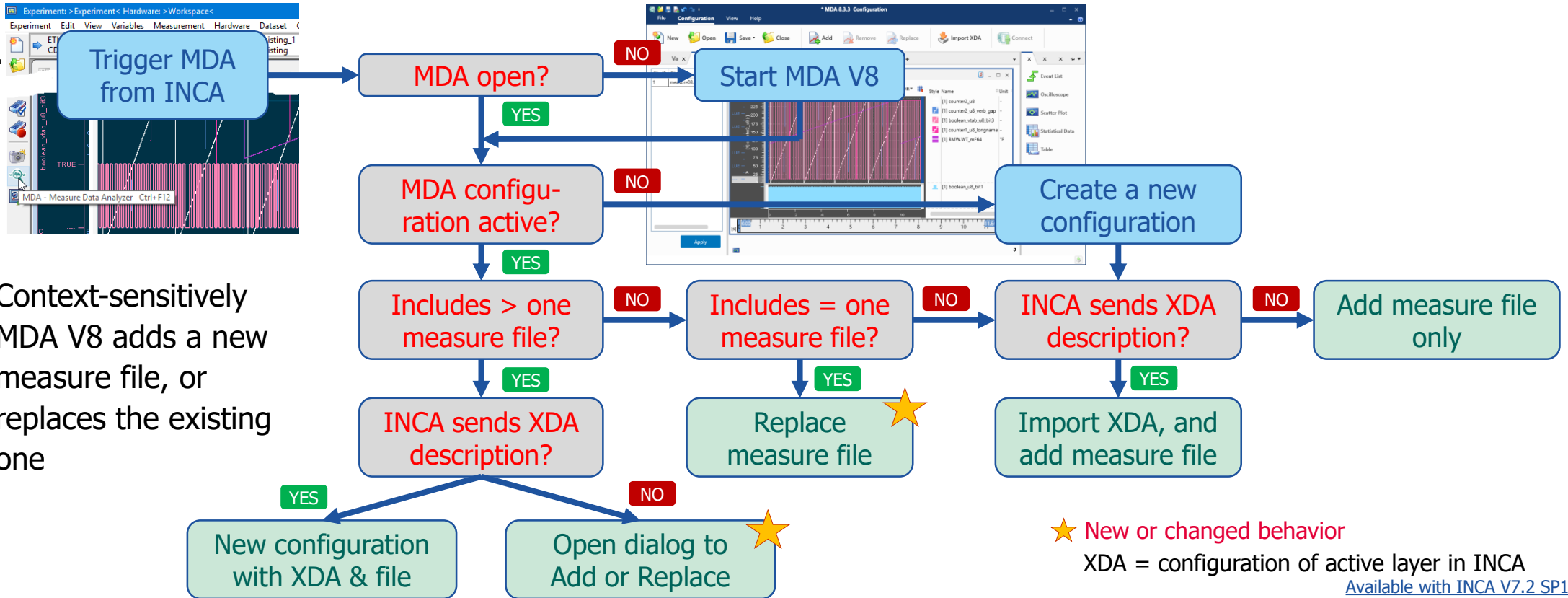

Context-sensitively MDA V8 adds a new measure file, or replaces the existing one

★ New or changed behavior

XDA = configuration of active layer in INCA

Available with INCA V7.2 SP14

INCA V7.2 – What's New

Functionality



Reuse Parts of Experiment – Recorder

The INCA DBB browser visualizes recorders in the Experiment Elements Window in the same way as measurement and calibration widgets

INCA displays additional info

- Device
- Raster
- Trigger

It is possible to copy / paste the recorder between different experiments. INCA handles the copied elements (measurements, trigger) in the same way as when layers / widgets are copied

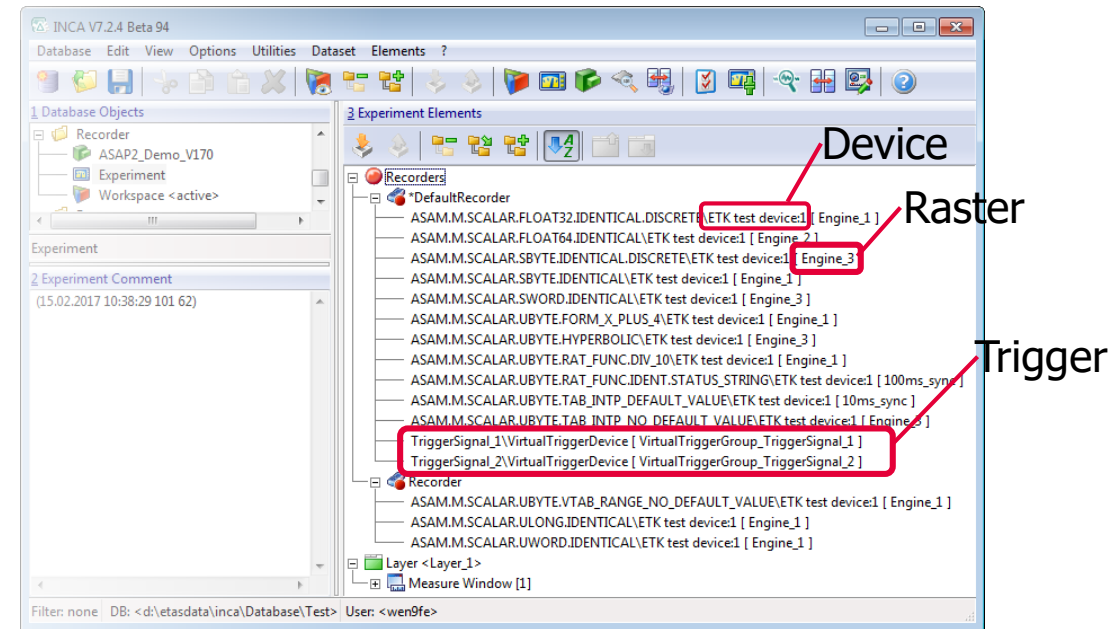

Available with INCA V7.2 SP4

INCA V7.2 – What's New

Functionality



Create Optimized exports for Drive Recorder (ES720/ES820)

For drive recorder use cases not all information is necessary. Therefore the drive recorder export coming with the Drive Recorder Add-on reduces the export file:

- Only used datasets are included
- CDM configurations are removed
- Application History is removed
- Key Variable Lists are removed

The additional option „optimized export“ reduces the export file once again:

- Calibrations not used in the experiment are removed
- Measure variables not being recorded are removed

Those optimizations lead to improvements in the drive recorder usage:

- Up to 25% faster loading and initializing of the experiment on a Drive Recorder
- Up to 60% smaller Drive Recorder export files compared to full export files
- Up to 30% less memory (RAM) consumption on a Drive Recorder



Available with [INCA V7.2 SP6](#)

INCA V7.2 – What's New

Functionality



Multi Raster – Measurements are updated even when some raster do not send data

INCA updates Measurement values even when some raster do not send data *)
(e.g. sync raster if Engine is stopped)

Multi Raster Support enabled

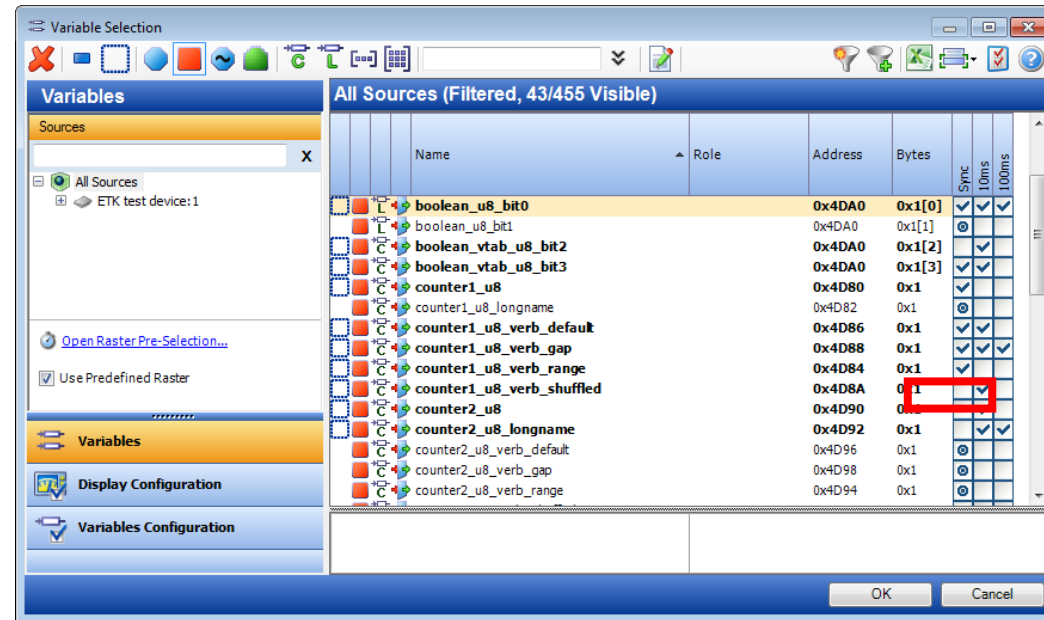
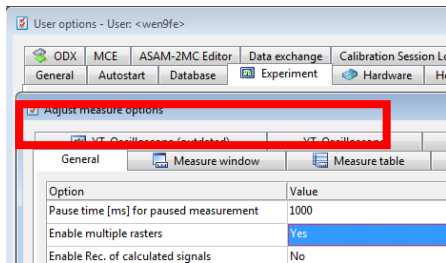

*) SP2: Only ETK; SP3: XCP & CCP added

Available with INCA V7.2 SP2

INCA V7.2 – What's New

Functionality



CDM – Default format for each action

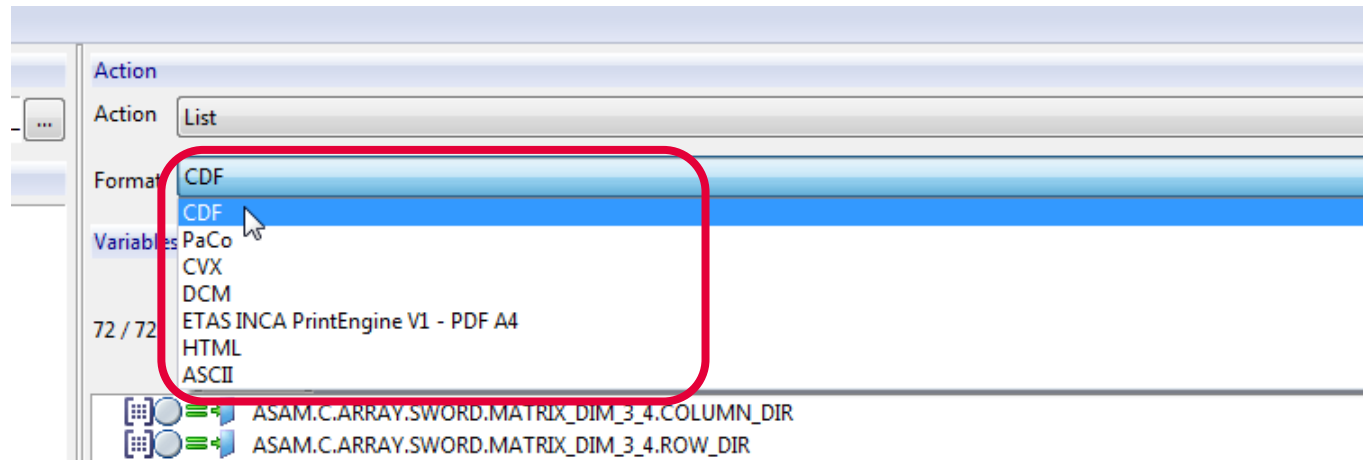

- CDM shows for each action the supported formats
- For each action CDM remembers the last selected format
- Pre-configuration by CDMdefault.ini is possible

INCA V7.2 – What's New

Functionality



CDM – Output path selectable

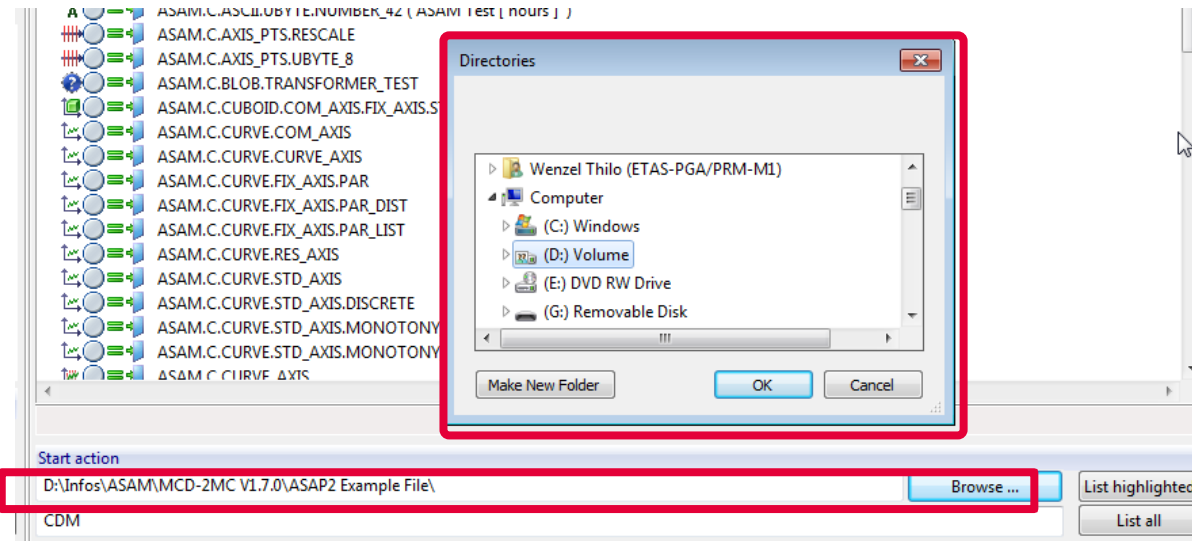

- CDM allows to select the output path by a path selection dialog
- Each configuration stores the selected path

INCA V7.2 – What's New

Functionality

CDM – Variables in the output file name

When generating a lot of files it is helpful to re-use information that is already available. CDM supports now variables in the output file name. By this the file name is automatically adapted to the related variable texts.

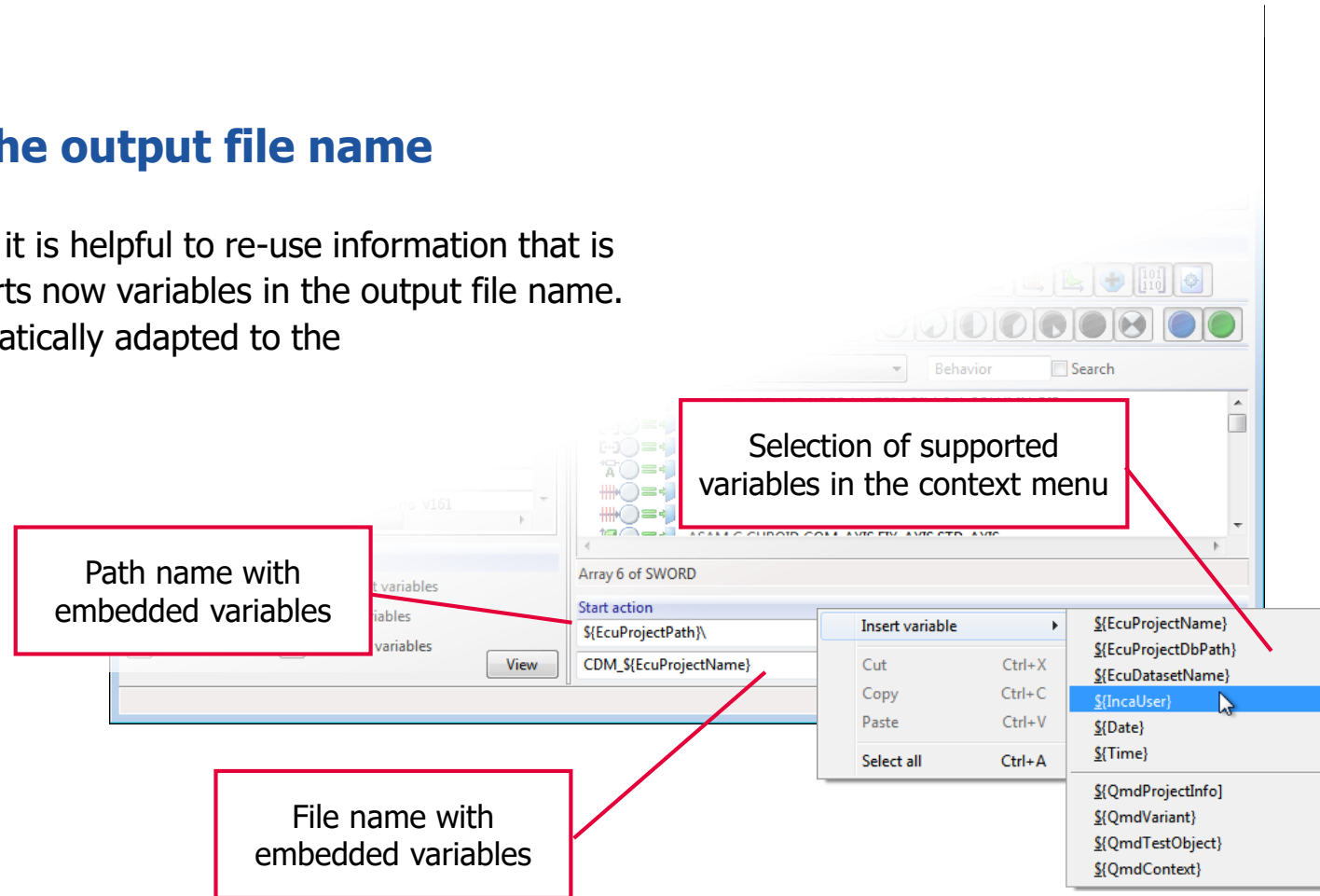

Available with INCA V7.2 SP6

INCA V7.2 – What's New

Functionality

CDM – Support COPY for Limited EMU RAM

If the working page on the ECU cannot cover all parameters CDM respects the same restrictions as the Experiments when working online.

Editing and Copy checks whether there is sufficient Emulation RAM to handle the changes on ECU side.



INCA Experiment

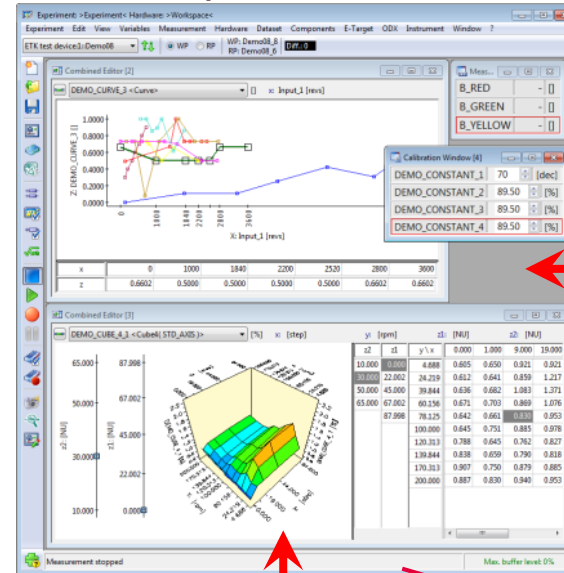

CDM open in parallel

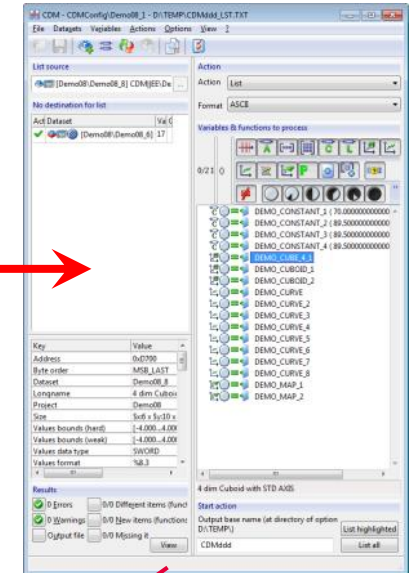

ECU

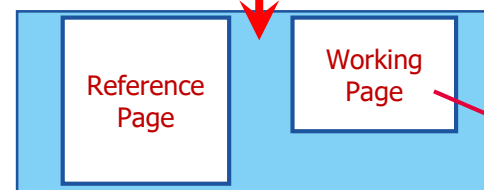

Respect the same ECU restrictions for Experiment and CDM

Limited EMU RAM

Available with INCA V7.2 SP12

INCA V7.2 – What's New

Functionality

Polling Mode – Option for Configuration

Polling allows to measure additional signals in parallel to the event driven measure modes of the different protocols. To ensure that the busses are not overloaded INCA supports

- A blocker that prohibits that polling raster are automatically used
- An option to configure INCA for polling in general

With the option "Enable measurement by polling" INCA can be configured individually.

This allows users that work with ECU without event based measurement to do polling and users that work with full CCP or XCP ECU to disable it.

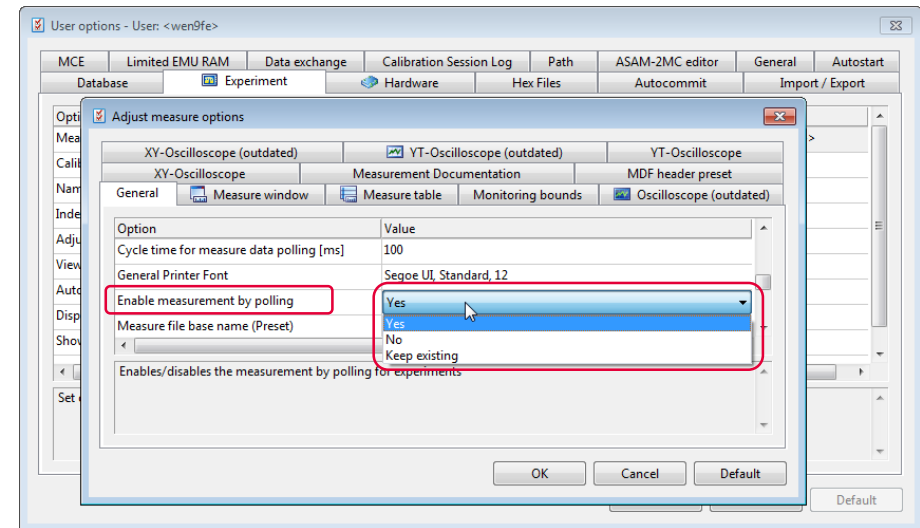

Available with INCA V7.2 SP10

INCA V7.2 – What's New

Functionality



EE – Dynamic appearance of Windows frame buttons

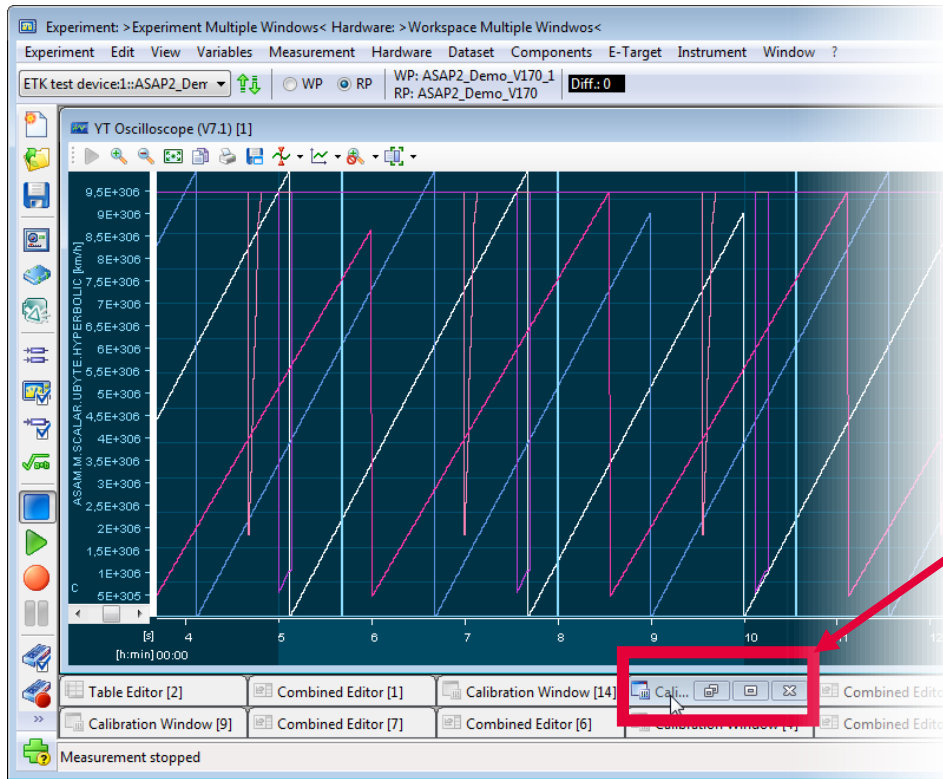

Frame Buttons are hidden for not active windows

- Headline better readable

Only frames with mouse over show the frame buttons

- Frame actions are available with one click

INCA V7.2 – What's New

Functionality



Experiment – Prevent unintended WP/RP switching

The difference between working and reference page could be huge. An unintended page switch may damage the engine. To avoid this INCA supports now an optional confirmation dialog.

As this is only necessary when there are critical differences between working and reference page the confirmation dialog can be enabled by an INCA user option.

Page switches via remote control are always possible, independent of the option setting.

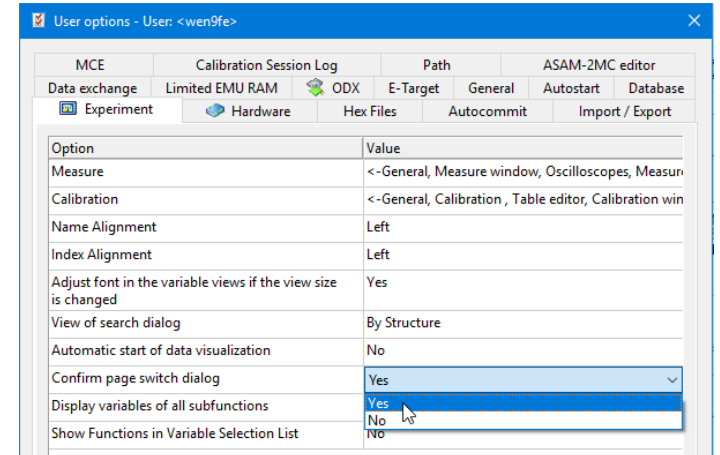
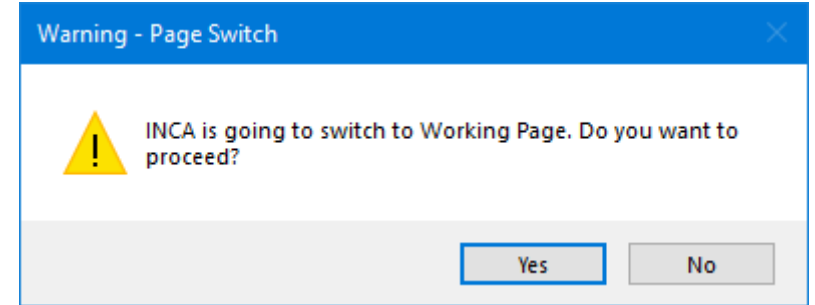

Available with INCA V7.2 SP13

INCA V7.2 – What's New

Functionality



Experiment – Improved UI support for Multi ECU handling

Show multiple devices

Memory Page Manager

Currently active device
(for hot keys)

Switch WP / RP

Differences

Hide detailed view

Component	WP	RP	Diff.
ETK test device:1 Demo09	<input type="radio"/>	<input checked="" type="radio"/>	2
ETK test device:2 Demo08	<input type="radio"/>	<input checked="" type="radio"/>	211
ETK test device:3 Demo09 - ASAP3	<input checked="" type="radio"/>	<input type="radio"/>	51

Measure	Value
Input_1	760 [revs]
Input_2	0.45 [ms/rev.]
MEASURE_T04	126.250 [mm2/st]
MEASURE_T05	5800.000 [rpm]
MEASURE_T06	20.000 [°C]
Output	-21.00 [degrees]
B_GREEN	False []
B_RED	True []
B_YELLOW	False []

Style	Name	Value
	A3_U08	68.00
	A3_U32	1,618.00
	A3_S32	1,600.00

Available with INCA V7.2 SP13

INCA V7.2 – What's New

Functionality



Editors – Paste from MS Excel

MS Excel allows to format cells in various ways.

To avoid wrong pasted values INCA uses a MS Excel specific clipboard format.

MS Excel

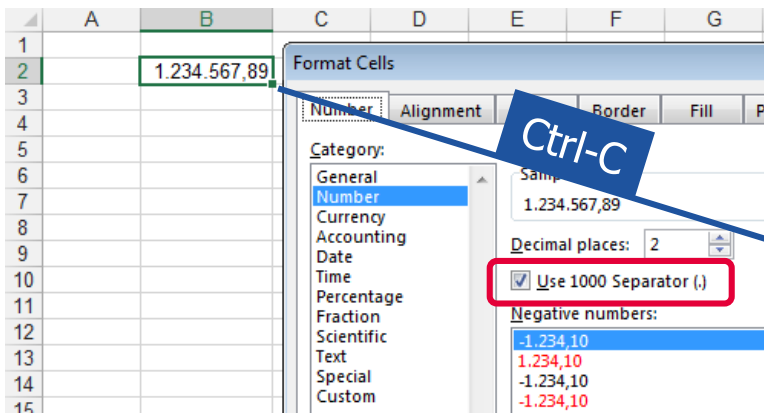

INCA Experiment

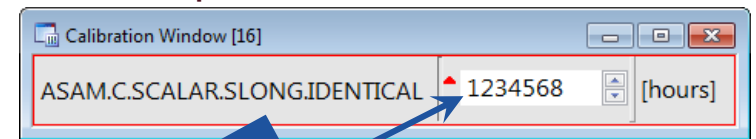

Clipboard "XML Spreadsheet"

```
<Cell>
  <Data>1234567.89</Data>
  <Format>\#\, \#\#0\.00</Format>
</Cell>
```

INCA V7.2 – What's New

Functionality



Editors – Bit Editor – Decimal numbering

To allow easier recognition of bit positions INCA allows to switch the bit position markers between decimal and hexadecimal counting.

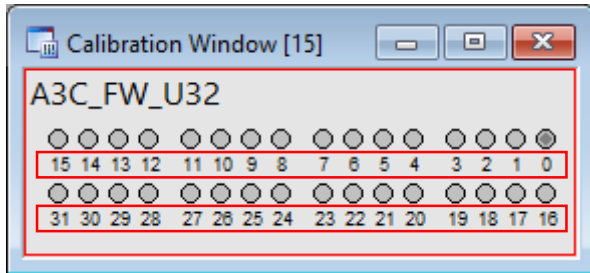

Ctrl-D: Decimal numbering

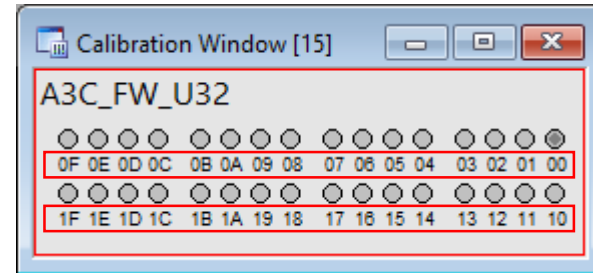

Ctrl-H: Hexadecimal numbering

[Available with INCA V7.2 SP12](#)

INCA V7.2 – What's New

Functionality



Combined Editor - Arrays

Combined Editor supports now arrays. The ASAP2 data types VAL_BLK, RES_AXIS, COM_AXIS can be now edited by the Combined Editor. This ensures that all data types have the same handling of "Limits", "Copy & Paste" ...

Arrays can be visualized graphically.

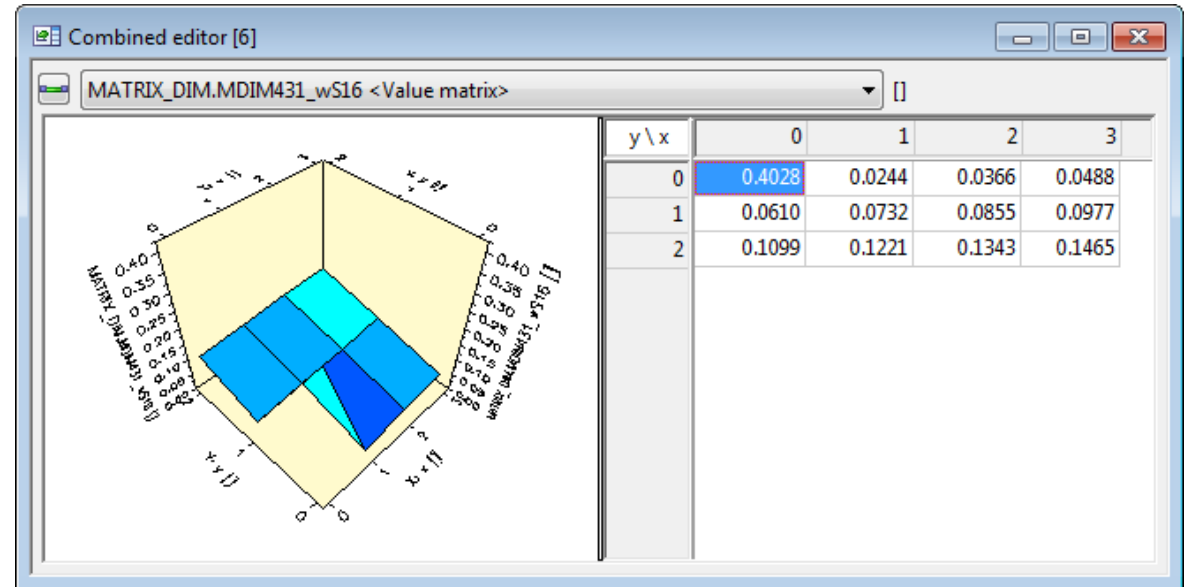

Available with INCA V7.2 SP10

INCA V7.2 – What's New

Functionality



VSD – Make variables inactive that are unique to layer

- Use Case
 - Create for each job to be done a dedicated layer in the Experiment
 - Deactivate layers (labels) which are currently not needed
- Extended context menu for layers in Variable Configuration Dialog
 - *Make variables active*
 - *Make variables inactive*
 - *All*
 - *Unique to layer*

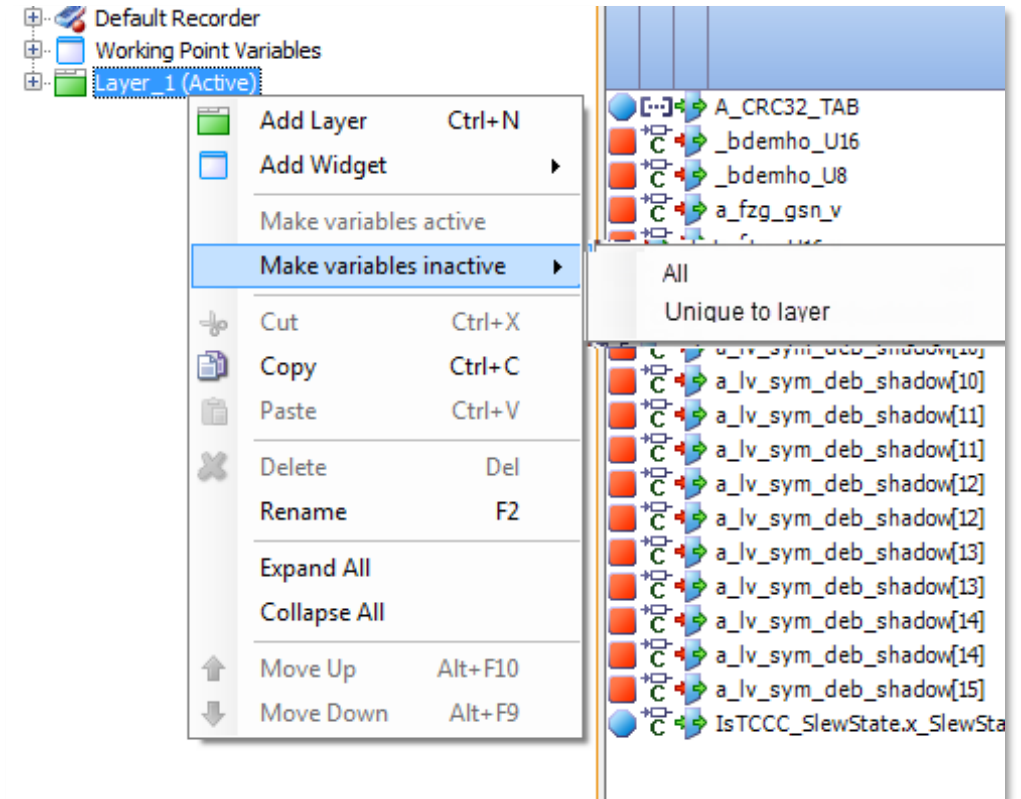

INCA V7.2 – What's New

Functionality

VSD – Easy selection of entire Functions or Groups in Experiment

- Functions and Groups will be listed in Variable Selection Dialog in the Experiment
 - Selecting a Function/Group will select all measure variables in that function
 - In addition all Calibration virtual measure variables selected
 - Controlled by User Option Experiment
 - >Show Functions in Variable Selection List->Yes
- Users can select variables faster and with less clicks

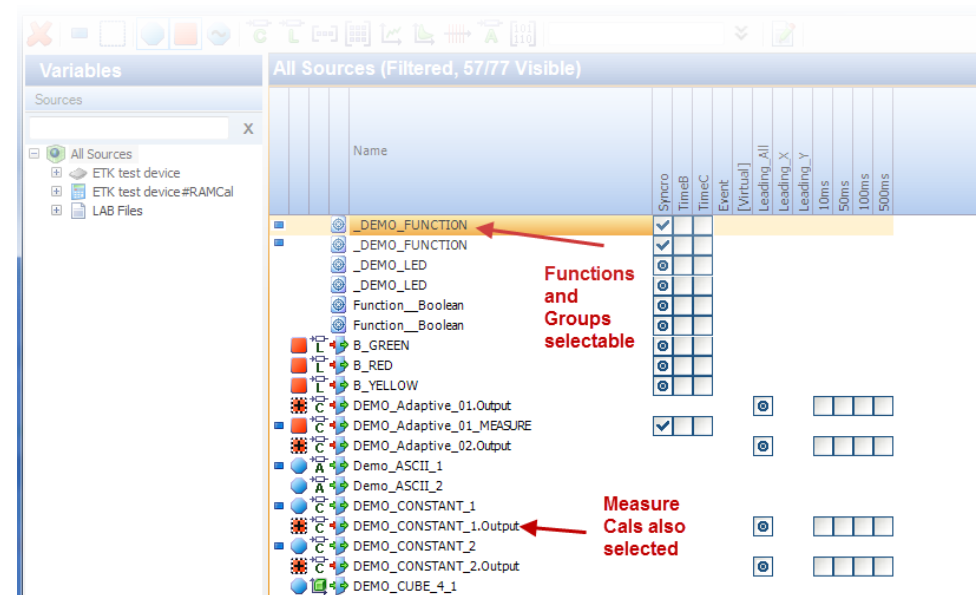





INCA V7.2 – What's New



Functionality

VSD – Display Function and Group selection status

- New Icons indicating the selection status
 -  : All Variables in Function/Group already selected
 -  : All Variables in Function/Group selected in this VSD session
 -  : Some variables of Function / Group already selected
 -  : Some variables of Function / Group selected in this VSD session
- Status Display in Variable list and Tree view

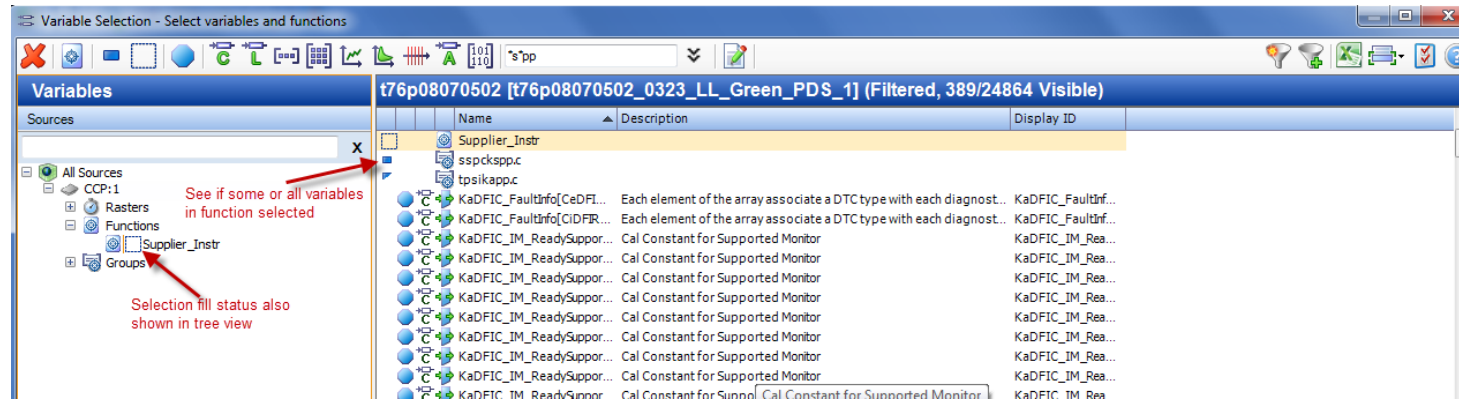

INCA V7.2 – What's New

Functionality

VSD – Add function list to Experiment tree

- Sources Tab added to Variable configuration
 - User able to filter variables by ECU function

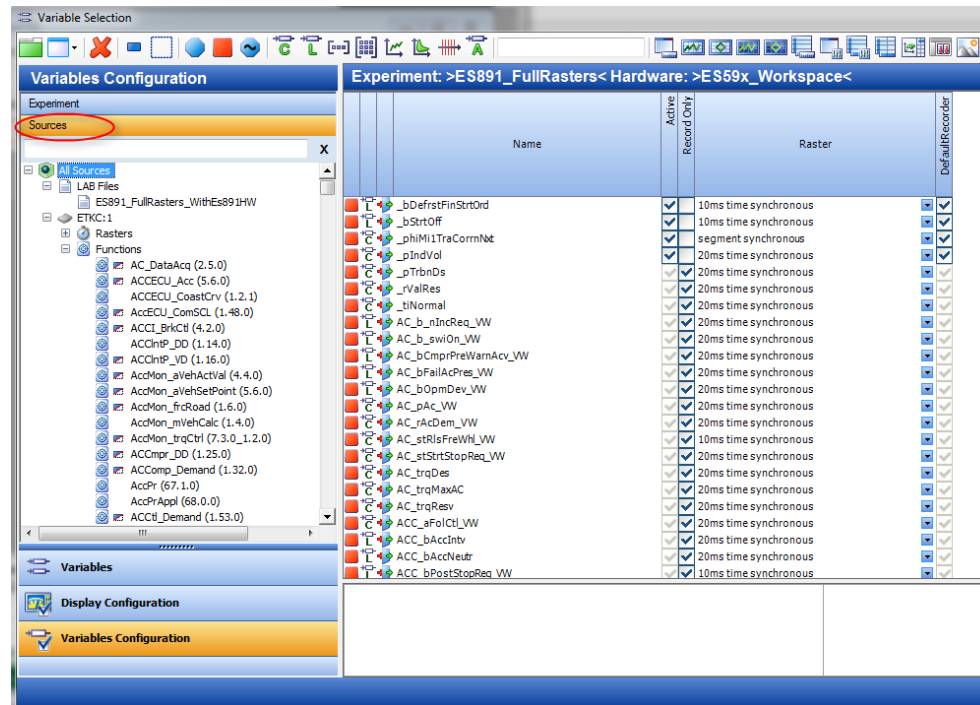

Available with INCA V7.2 SP1

INCA V7.2 – What's New

Functionality

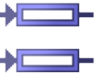

VSD – Add function list to Experiment tree (Cont)

- Sources tab selected automatically from Raster overflow dialog

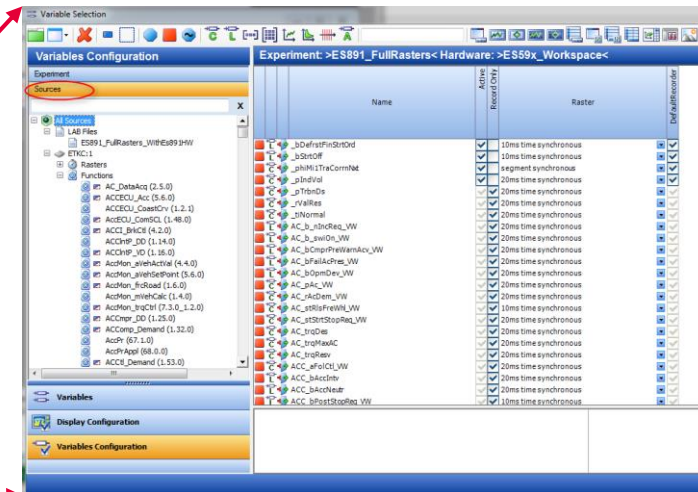
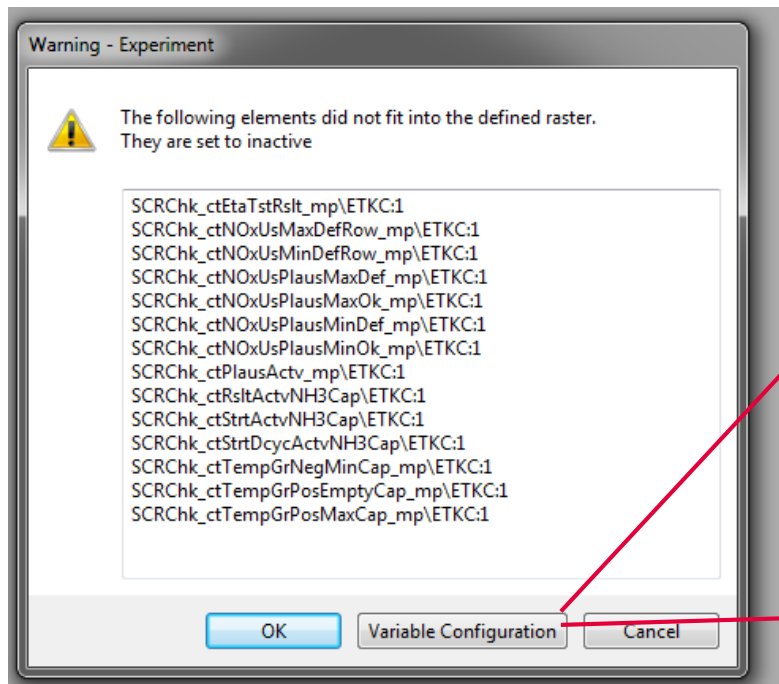

Available with INCA V7.2 SP1

INCA V7.2 – What's New

Functionality

VSD – Easy Raster re-assignment for changed ECU software

In A2L files, the predefined raster for measurement labels can be defined. INCA can use this information for setting up an experiment. When loading a new version of an A2L file with this experiment the predefined raster can have changed.

New: Users can quickly adapt their experiment to the new A2L by having INCA check and reassign all labels to their predefined raster. This is specially helpful for multi-core ECUs where raster are defined for each core

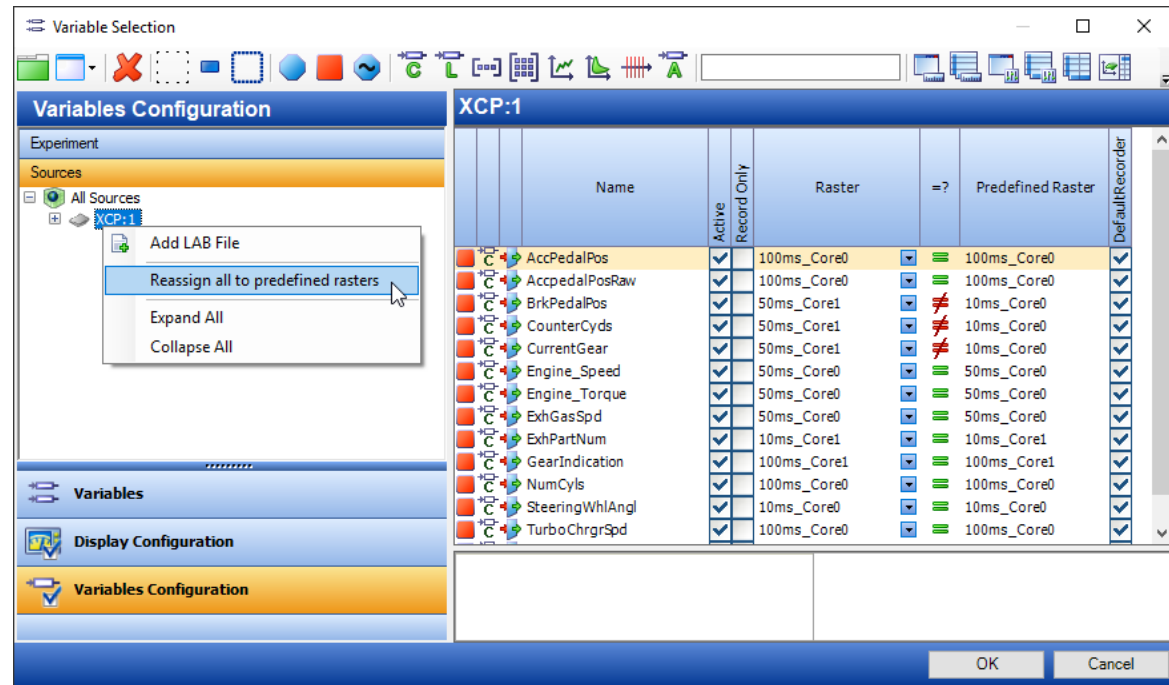





Available with INCA V7.2 SP13

INCA V7.2 – What's New

Functionality

Support New LAB format in VSD for Filters

- Functions from the LAB file
 - Current selection level
- Groups from the LAB file
 - Current selection level
- Signals from the LAB file
- Raster Info
 - Raster by A2L file 
 - Raster by LAB file 
 - Raster selected 
 - Including multi raster 

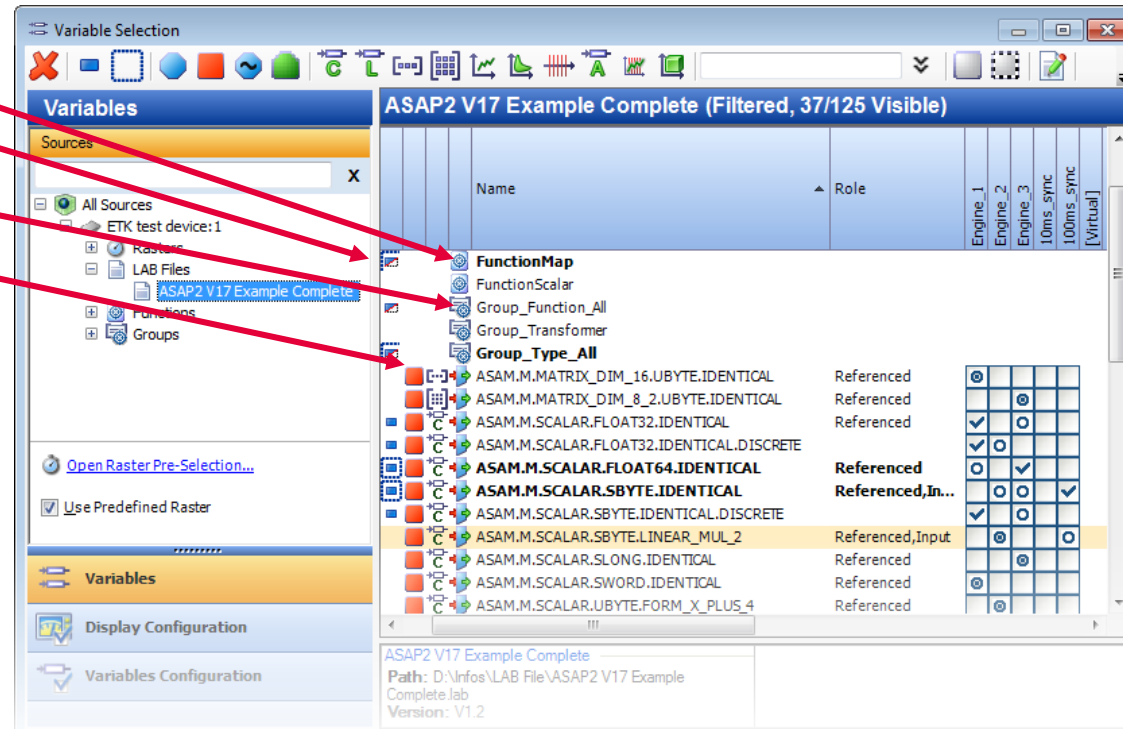

Available with INCA V7.2 SP3

INCA V7.2 – What's New

Functionality

VSD – Filter for non-selected Variables

Beside the filters for

■ “part of experiment”

□ “selected”

It is now possible to filter

□ “remaining” variables

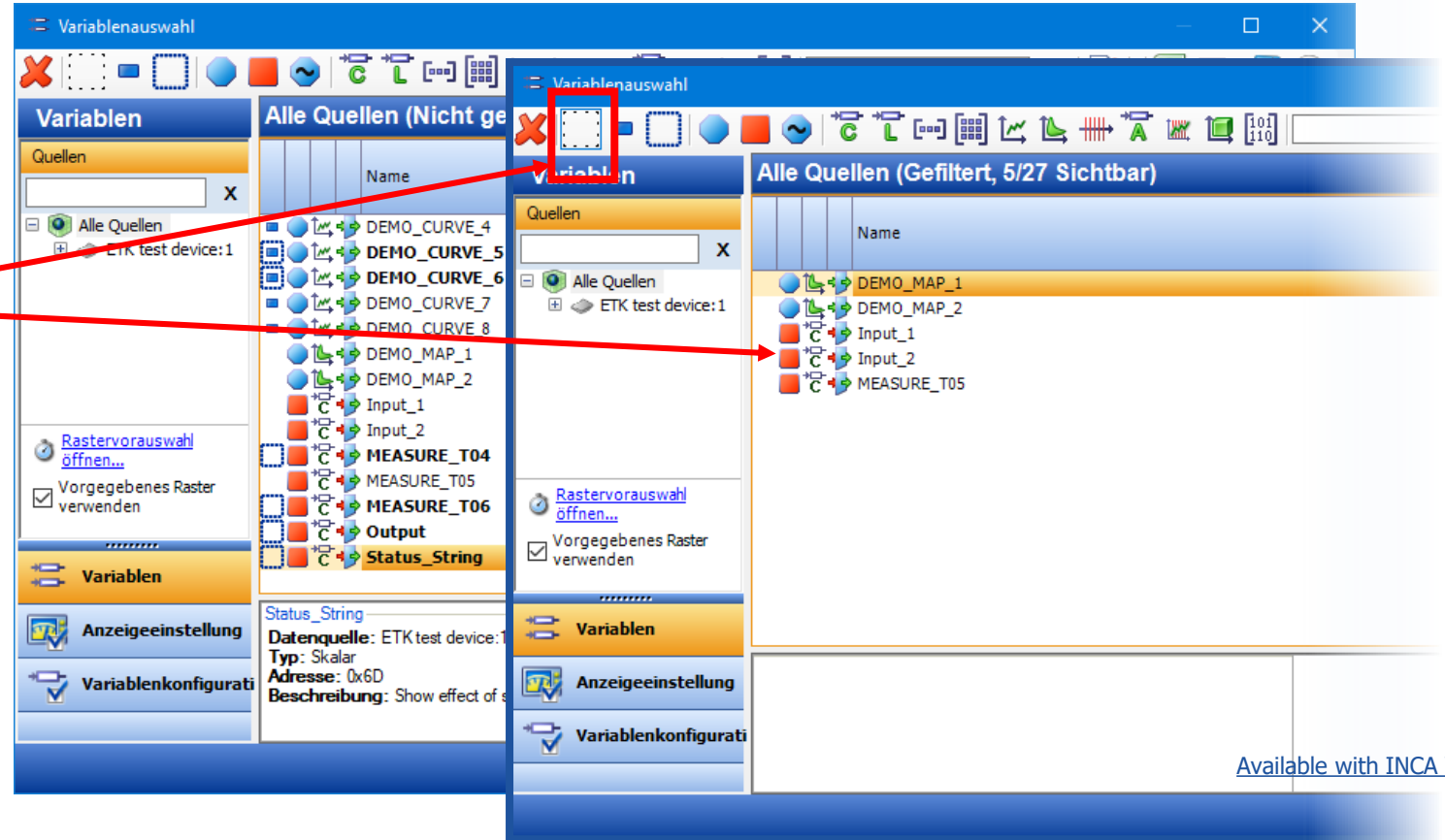

Available with INCA V7.2 SP11

INCA V7.2 – What's New

Functionality

VSD – Sorting by all columns

Beside the text columns
it is now possible to sort
the columns with icons too

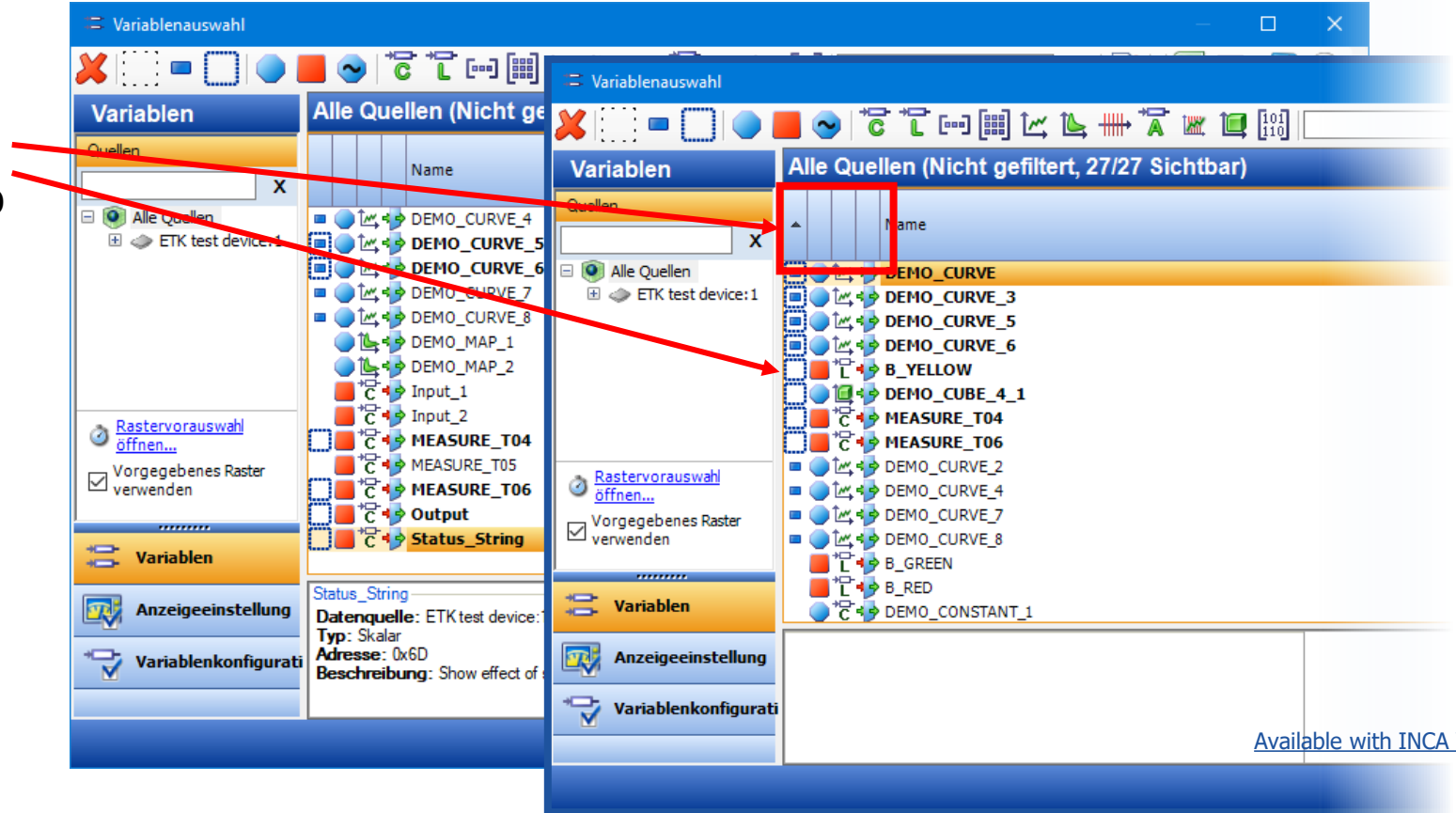

Available with INCA V7.2 SP11

INCA V7.2 – What's New

Functionality

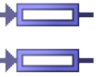

Variable Selection Dialog – Visualization of predefined Raster – 1 of 2

To indicate whether a measurement is selected in an predefined or preselected raster INCA shows this info beside the selected raster.

- Selected Raster
- Predefined (in A2L) or Preselected (in INCA)

Works for raster defined in LAB-files too.

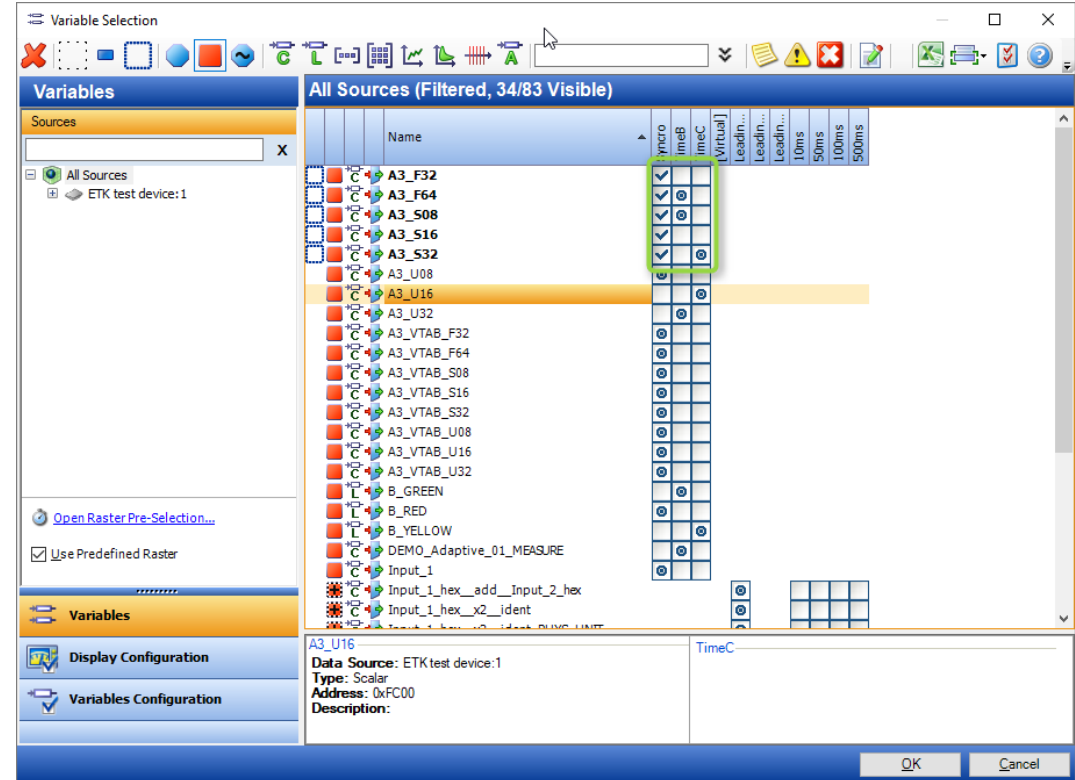

Available with INCA V7.2 SP12

INCA V7.2 – What's New

Functionality

Variable Selection Dialog – Visualization of predefined Raster – 2 of 2

The “Variables Configuration” has now

- new column “Predefined Raster”
- improved sorting logic for the existing column “=”; the column shows if the variable is selected in the predefined raster(s) or not

The user can sort the experiment variables by the column “=”, multi-select the variables with the same predefined rasters, press “F2” in “Raster” column and move the selected variables to the predefined raster in one click

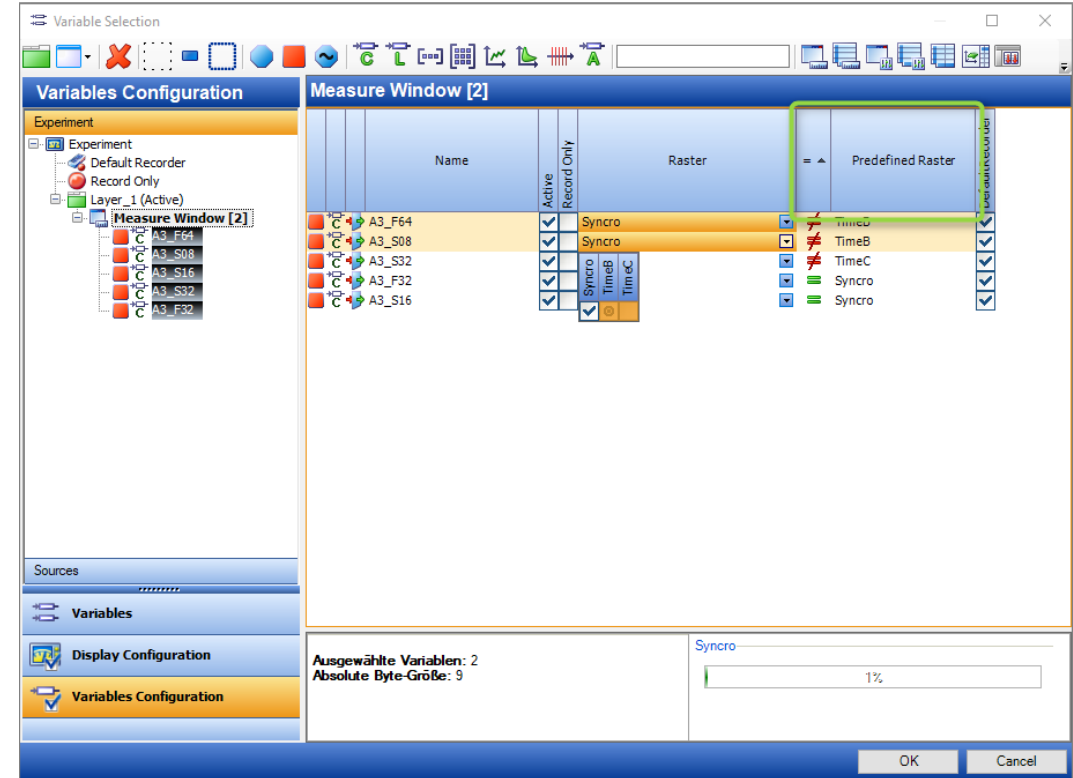

Available with INCA V7.2 SP12

INCA V7.2 – What's New

Functionality



XETK – Display Raster Check Details for Distab 13

The Raster Info gives now more details about the filling level

GREEN

You can add any kind of measurement

YELLOW

Restrictions available

RED

No more measurements can be added

Variable Selection

Rasters (Not Filtered, 3166/3166 Visible)

Measure	Progress	Color	Restriction
Measure_R01	97%	Green	None
Measure_R02	96%	Green	None
Measure_R03	49%	Yellow	Soft restriction: No more two byte measurements possible
Measure_R04	100%	Red	Hard restriction: No more Distab addresses available
Measure_R05	49%	Yellow	None
Measure_R07	97%	Yellow	None
Measure_R08	49%	Yellow	None

Available with INCA V7.2 SP11

INCA V7.2 – What's New

Functionality



ETK – Select the ETK interface when working offline

The A2L file with the ECU description allows to define multiple interfaces. This allows to describe multiple ECU configurations with one A2L file.

When the ECU is connected to the PC INCA detects the used ETK interface automatically.

The option "Device Selection" allows to pre-select the device that INCA uses offline.

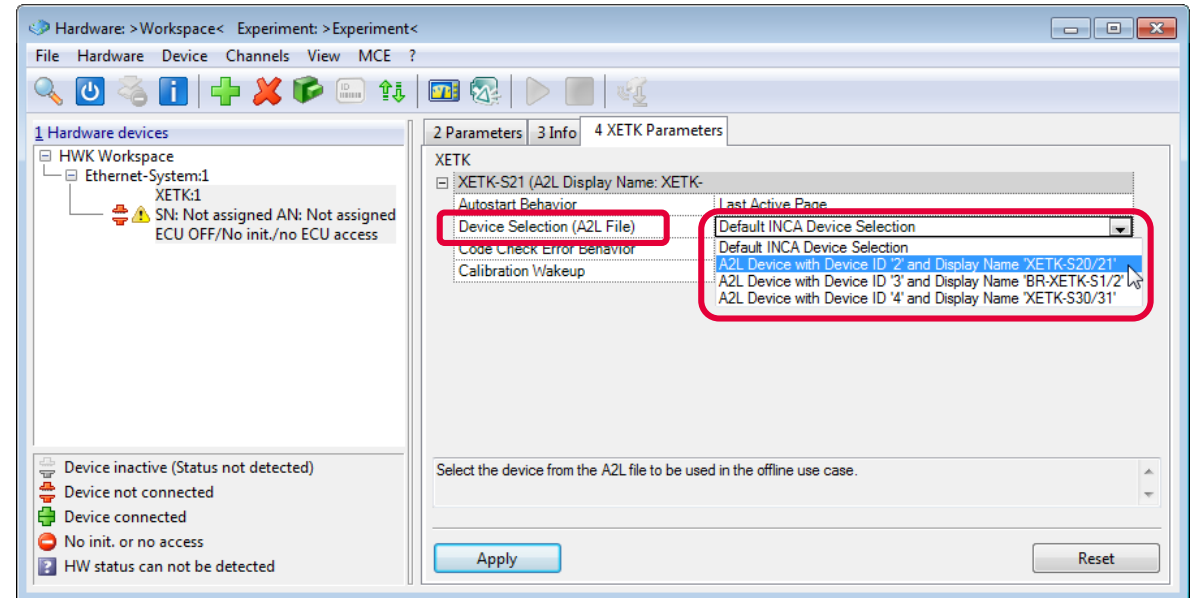

Available with INCA V7.2 SP10

INCA V7.2 – What's New

Functionality

Limited EMU RAM – Download for Data Freeze

Data Freeze for Serial ETK with Limited EMU RAM is per Download *) possible

- Experiment Preparation Mode
- Dynamic Emulation Mode

*) INCA uses internally ETK flashing.
No PROF configuration necessary.

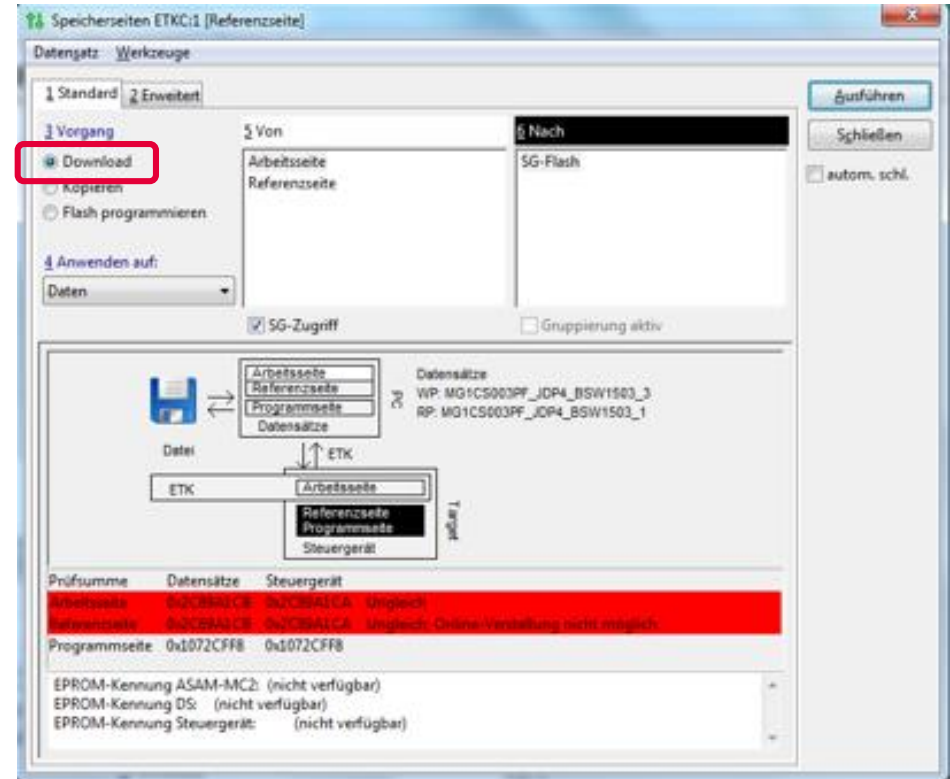

Available with INCA V7.2 SP1

INCA V7.2 – What's New

Functionality

Dynamic Emulation Mode – Calibration when Reference Page is different

For dynamic emulation INCA allows calibration on the working page (WP) when the reference page (RP) is different but all calibrations can be covered by the Emulation RAM.

- For recording INCA writes a comment in the MDF file that the RP is different. This gives the user a hint that recorded calibration values may not be identical to the ECU values
- To enable the functionality INCA supports the setting "Dynamic Emulation" = "Allow calibration with different RPs"

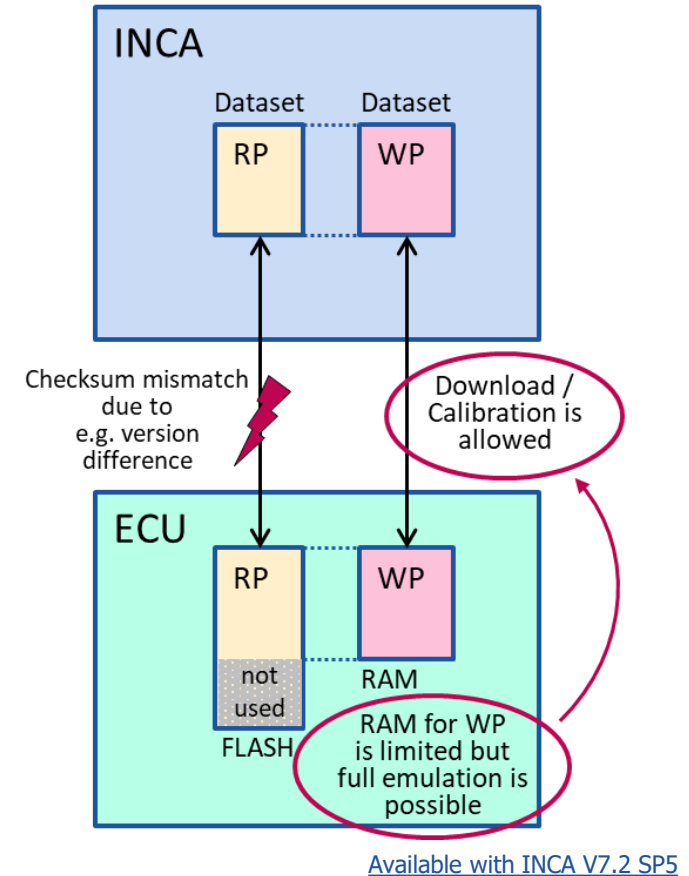
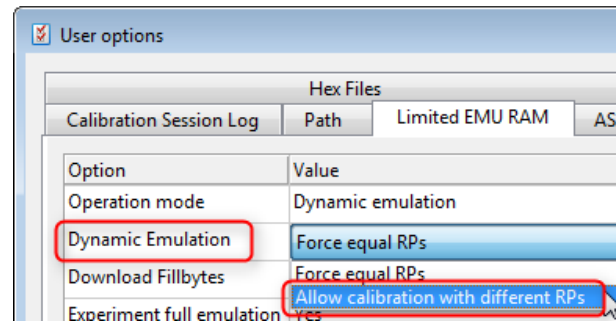

INCA V7.2 – What's New

Functionality



COM-API – Support of 32Bit and 64Bit Clients

- The INCA Tool API supports 32Bit and 64Bit Clients
- The INCA Add-on MIP supports 32Bit and 64Bit Matlab® *)



*) The Add-on MIP supports 64Bit Matlab® beginning with R2015b

[Available with INCA V7.2 SP1](#)

INCA V7.2 – What's New

Functionality



COM-API – Support of Bus Monitoring

For some bus monitoring applications it makes sense to exchange the bus descriptions often.

INCA supports the remote access to add the bus description to the INCA database,

- ReadCanDBFile
- ReadAutosarFile
- ReadFibexFile
- ReadLdfFile

and assign it to a monitoring device.

- HWProjectSystem.SetProject

Supported bus monitoring descriptions

CAN DB	for CAN, CAN FD, J1939
Autosar V4.1, 4.2, 4.3	for CAN, CAN-FD, Flexray
Fibex V3.0, 3.1	for Flexray
LDF V1.3, 2.3	for LIN

[Available with INCA V7.2 SP8](#)

INCA V7.2 – What's New

Functionality



COM-API – Support of CUBOID

The screenshot displays the .Net Tool-API Documentation window for the `GetValue()` method of the `CalibrationThreeDTableData` class. The documentation includes the following details:

- Namespace:** `de.etas.cebra.toolAPI.Common > CalibrationThreeDTableData > GetValue()`
- Description:** Gets the value and returns a Cube3Data object see also "de.etas.cebra.toolAPI.Common.MatrixData"
- Declaration Syntax:**

```
public virtual CalibrationCube3Data GetValue ()
```
- Return:** Experiment: > Experiment< Hardware: > Workspace_V1.7.1<

The combined editor window shows a 3D plot of a cube with axes labeled `ASAM.M.SCALAR.SBYTE.IDENTICAL [h...`, `ASAM.C.CUBOID.COM_AXIS.FIX_AXIS.STD_AXIS <Cu [hours]`, and `ASAM.M.SCALAR.SBYTE.I...`. The plot is overlaid with a blue cube. To the right of the plot is a data table:

z	y \ x	0	1	2	3	4	5	13	1
2	1	515	2305	3	4	5	8	7	ε
4	2	9	8	11	12	13	8	513	102
15	3	1541	2055	9	20	21	770	260	25ε
31									

Remote Access
via COM to parameters
of type CUBOID

Available with INCA V7.2 SP9

INCA V7.2 – What's New

Functionality



COM-API – Support of CUBE_4

The screenshot displays the .Net Tool-API Documentation window for the `CalibrationAbstractFourDTableData` constructor. The documentation includes the following declaration syntax in C#:

```
public CalibrationAbstractFourDTableData (
    SmalltalkToolAPI existingHandle,
    Identifiable newHandle
)
```

Below the documentation, the ETAS software interface is shown. The 'Combined Editor [15]' window displays a 3D plot of a CUBE_4 data set. The plot shows a green cube and a blue cube within a yellow bounding box. The axes are labeled with parameters: `z2: ASAM.M.SCALAR.SBYTE.IDENTICAL [hours]`, `z1: ASAM.M.SCALAR.SBYTE.IDENTICAL [hours]`, and `y: ASAM.M.SCALAR.SBYTE.IDENTICAL [hours]`. To the right of the plot is a data table:

	z2	z1	y \ x	1	2
1	1	1	1	9	14
2	2	2	2	15	16
3	3	3	3	17	34
4					

Remote Access
via COM to parameters
of type CUBOID

Available with INCA V7.2 SP10

INCA V7.2 – What's New

Functionality



COM-API – Check if ECU is turned on/off

New COM-API functions

1. `bool IsTargetEcuOff()`
detects the suspended/off state of the connected ECU
2. `bool SetAsyncBuffersToInvalid()`
clear latest/cached asynchronous measure value == display '-' measure value in EE

Both methods can be used to detect whether the ECU is in the driver program or left the program after power down (KL 15 off) or power up (KL 15 on)

[Available with INCA V7.2 SP11](#)

INCA V7.2 – What's New

Functionality



COM-API – Support of Test Settings

The following INCA options are now available via INCA COM-API

- **'Cycle Time For TS data Polling'** (INCA \ Experiment \ Measure \ General)
- **'Cycle Time'** (INCA \ Experiment \ Measure \ General)
- **'Strict Increasing'** (INCA \ Experiment \ Calibration \ General)
- **'Database Path'** (INCA \ Path)

[Available with INCA V7.2 SP15](#)

INCA V7.2 – What's New

Functionality



Database – Export only referenced data sets

When a complete INCA workspace shall be exported it is possible to decide whether all data sets of the INCA project are exported or only the referenced ones.

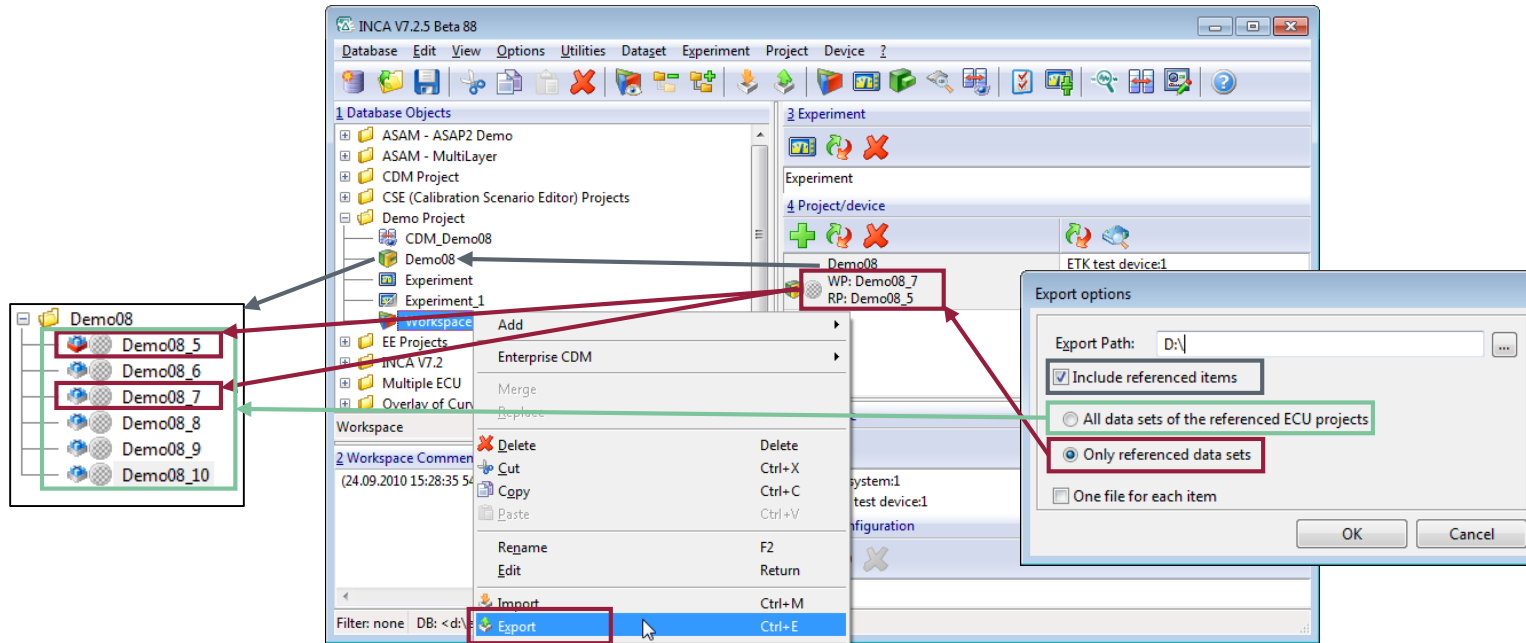

Available with INCA V7.2 SP5

INCA V7.2 – What's New

Functionality



Limited EMU RAM – Support of Renesas RH850 Overlay RAM

The Renesas RH850 Micro-controller family supports multiple flash memory clusters. For calibration each cluster needs a specific handling of the assigned Overlay RAM

INCA supports the RH850 memory overlay mechanism to allow calibration for all flash clusters. INCA optimizes the usage of global and cluster specific Overlay RAM

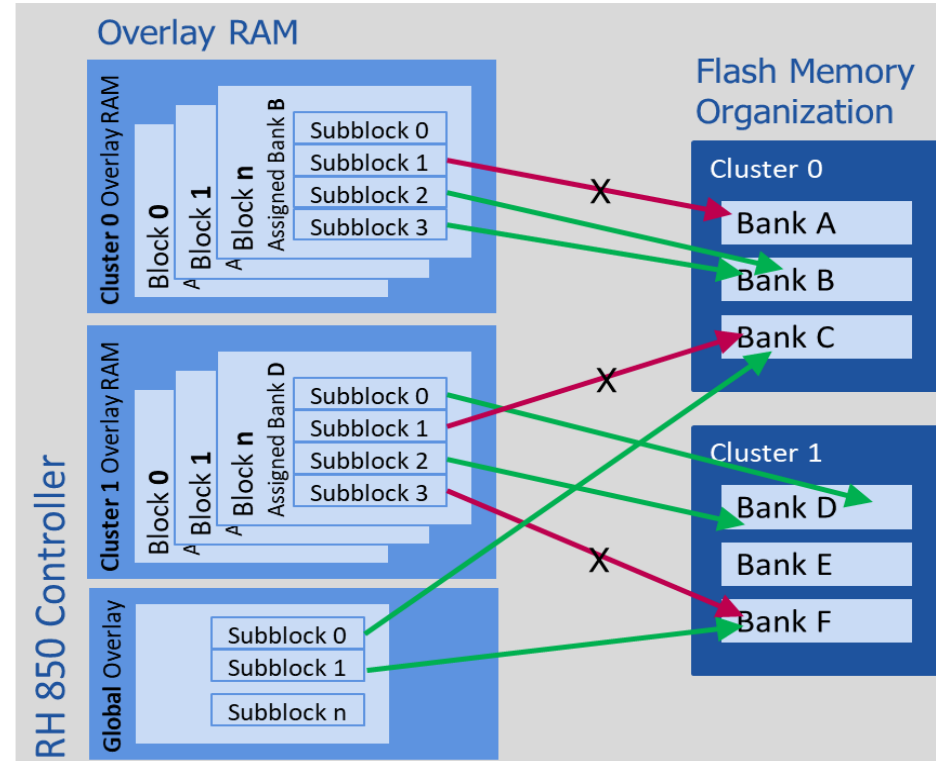

Available with INCA V7.2 SP8

INCA V7.2 – What's New

Functionality



64 Bit Integer Support (limited to 32bit value range)

The new generations of ECU controller support 64 Bit registers. To allow high performant data access the 64 Bit registers need to be read with one access. Normally data is less than 64 Bit in size, multiple data is stored in one 64 Bit data package.

INCA supports 64 Bit Integer access to read / write it with one access. 1) To separate the different information INCA supports 64 Bit Bitmasks. 2)

ECU 64 Bit Value

1011 0011 1010 0011 1011 0011 1011 0011 1011 0111 1001 0010 1011 1001 1011 1000

Bitmask for Signal A

0000 0000 0000 0000 0000 0000 0000 0000 0000 0000 0000 0000 1111 1111 1111 1111

Value Signal A

1011 1001 1011 1000

Bitmask for Signal B

0000 0000 0000 0000 0000 0000 0000 0000 1111 1111 1111 1111 0000 0000 0000 0000

Value Signal B

1011 0111 1001 0010

¹⁾ Monitoring is limited to 32 Bit data types

²⁾ The Bitmask must have max 32 Bits active; All active bits must be in one sequence

Available with [INCA V7.2 SP8](#)

INCA V7.2 – What's New

Functionality



64 Bit Integer Support (full range)

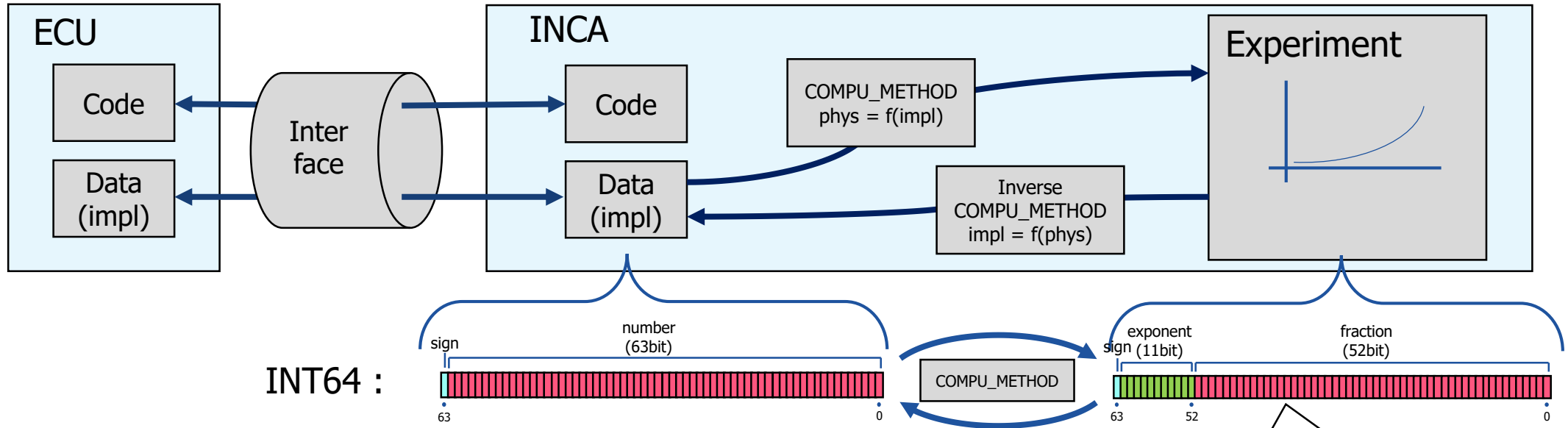

- Full 64 bit support for implementation values
- On physical side restriction to 52 bit precision of float

Available with INCA V7.2 SP14

INCA V7.2 – What's New

Functionality



Alias Name – Show and edit it in the Hardware Configuration

When going from one car to another car where more than one device of the same type is in use it is necessary to uniquely assign/identify hardware.

- E.g. two ETAS hardware devices of same type, like two XETKs
The serial number is not always helpful to see which device serves which function

To support this use case an alias name can be stored in the hardware device.
INCA displays it in:

- Search for hardware dialog
- Hardware mapping dialog

For an automatic hardware mapping, the INCA device name should be the same as the alias name

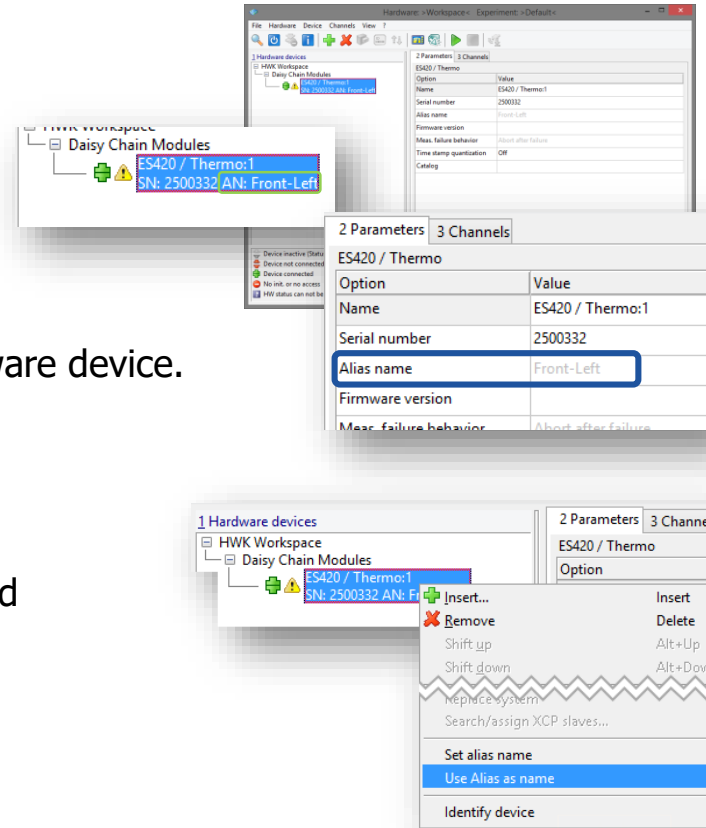

Available with INCA V7.2 SP8

INCA V7.2 – What's New

Functionality



INCA – "NaN" resp. "Inf" display in INCA

Why is NaN (Infinity) relevant for ECU data?

Numbers used on the ECU

New, powerful controllers have dedicated floating point units and can do floating point operations in hardware without performance loss. Here the ECU has to handle invalid float values (NaN).

Physical Data Model

To allow easier handling of the ECU data the ECU internal model is transferred to a physical model. For this computation methods define a formula $\text{phys} = f(\text{impl})$. If this formula contains e.g. a term $1/x$ infinite results (Infinity) are possible.

➤ **INCA supports now NaN and Infinity for its browsers and editors** *)

[Available with INCA V7.2 SP11](#)

*) *additional information as separate slide set available*

INCA V7.2 – What's New

Functionality



Database – Check for overlapping Parameters

If two parameters share the same memory a calibration of one parameter influences the other. This is not always intended. Parameters often need multiple bytes to store the values. A simple check of different start addresses does not detect all overlaps

INCA supports now a check that respects beside the address also the size of the parameter. The check can be started manually for INCA projects (A2L files)

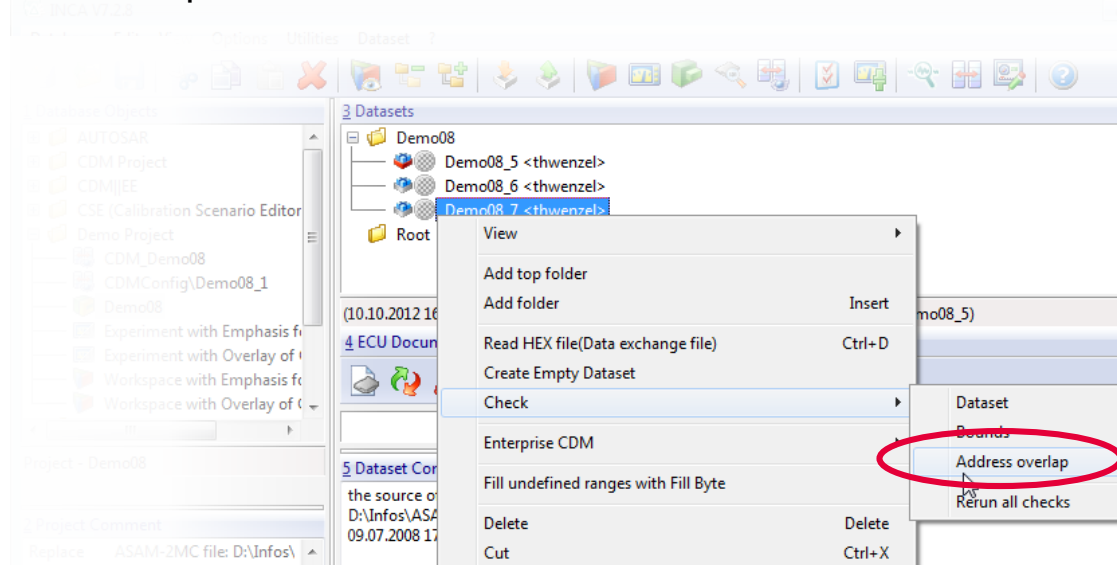

Note: overlapping parameters with different bitmask are detected too

Available with INCA V7.2 SP8

INCA V7.2 – What's New

Functionality



DBB - New HEX/S19 File Filter

If working with Intel and Motorola files it is easier to have a combination of file filters

- INCA supports now an "All hex files" filter
- INCA remembers the last used filter type for the current session

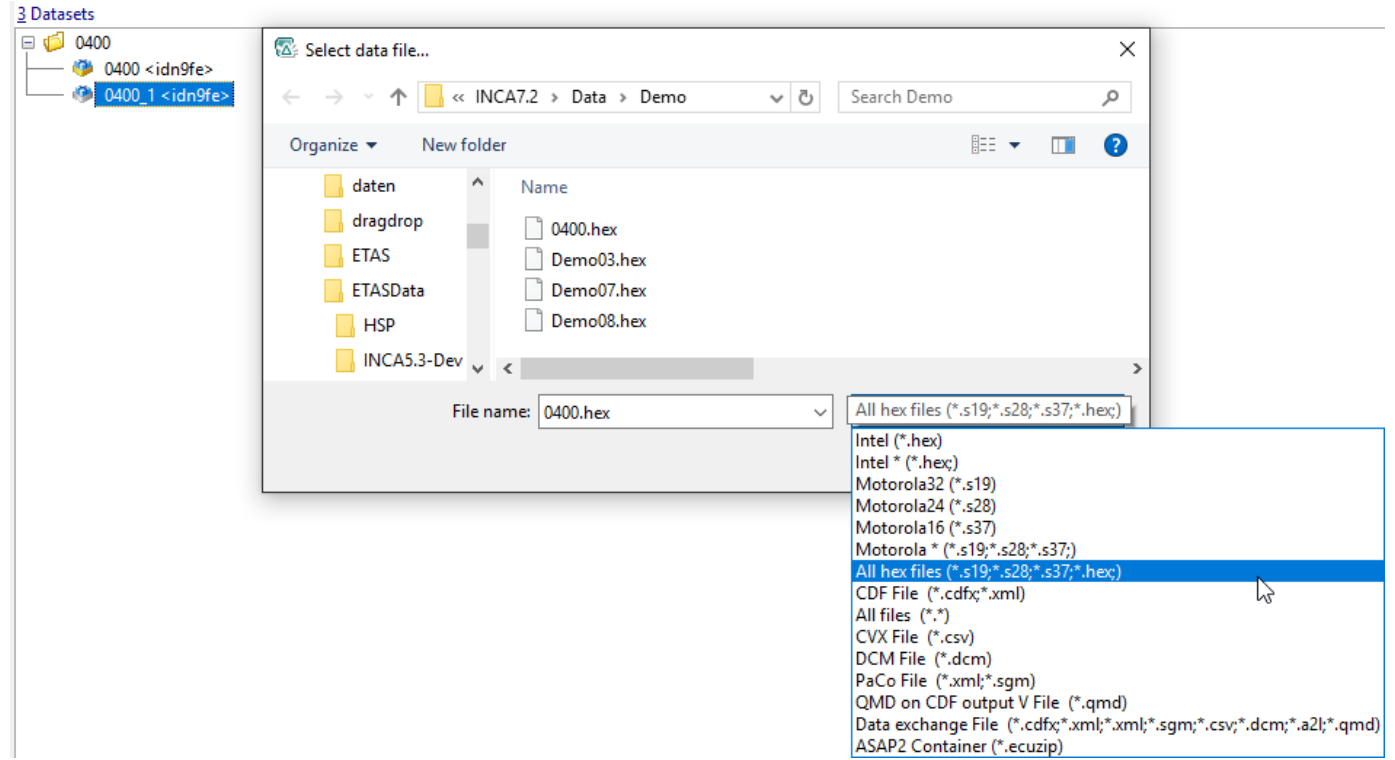

Available with INCA V7.2 SP11

INCA V7.2 – What's New

Functionality



Reduction of outdated INCA files

During installation and INCA usage log files and temporary files are written. These files were never deleted by INCA, the number of files increased steadily and wasted unnecessary space on the user's hard drive.

The INCA user now has the possibility to delete the temporary files and log files by selecting "*Clean up deprecated files...*" in the INCA Utilities menu

The files are deleted after INCA was closed

- ETAS\LogFiles\Inca
- ETAS\LogFiles\ProcessLogsV2
- ETAS\LogFiles\TgtSvr
- ETAS temp folder (only if not equal to system temp folder)
- (The list can be extended in future.)

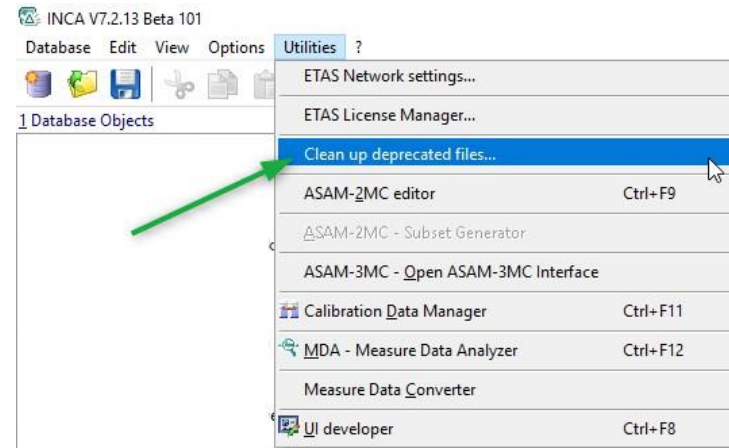

Available with INCA V7.2 SP13

INCA V7.2 – What's New

Overview

1. Product information (Use cases, Sample applications, Customer value) 3. Phase out information

- Performance
- Functionality
- **Standards**
- Usability
- HW support
- Add-ons

2. INCA Product Family

4. General Notes

INCA V7.2 – What's New

Standards



AUTOSAR – Support of Autosar V3.2.x for Flexray

- INCA supports Autosar Description Files V3.2 for Flexray Monitoring

Description file / Transport layer		Monitor							MC	
Desc. File	Version	CAN	CAN-FD	J1939	LIN	Ethernet/AETH		FlexRay	XCP on Flexray	
						DoIP	Some/IP			
AUTOSAR	3.0	NS	NA	NS	NS	NA	NA	NA	NS	NS
	3.1	OK	NA	NS	NS	NA	NA	NA	NS	NS
	3.2	OK	NA	NS	NS	NA	NA	NA	OK	NS
	4.1	OK	OK	NS	NS	NS	NS	NS	OK	NS
	4.2	OK	OK	NS	NS	NS	NS	NS	OK	NS
	4.3.0	OK	OK	NS	NS	NS	NS	NS	OK	NS
	4.3.1	OK	OK	NS	NS	NS	NS	NS	OK	NS
	4.4.x	NS	NS	NS	NS	NS	NS	NS	NS	NS
FIBEX	1.1.5a	NS	NA	NA	NS	NA	NA	NA	OK	OK
	1.2.0a	NS	NA	NA	NS	NA	NA	NA	OK	OK
	2.0.0	NS	NA	NA	NS	NA	NA	NA	OK	OK
	2.0.1	NS	NA	NA	NS	NA	NA	NA	OK	OK
	FIBEX+	NS	NA	NA	NS	NA	NA	NA	OK	OK
	3.0	NS	NA	NA	NS	NA	NA	NA	OK	OK
	3.1	NS	NA	NA	NS	NA	NA	NA	OK	OK
	4.1.0	NS	NS	NA	NS	NS	NS	NS	NS	NS
4.1.1	NS	NS	NA	NS	NS	NS	NS	NS	NS	
4.1.2	NS	NS	NA	NS	NS	NS	NS	NS	NS	
CAN DBC		OK	OK	OK	NA	NA	NA	NA	NA	NA
J1939 DBC		NA	NA	OK	NA	NA	NA	NA	NA	NA
LDF	1.2	NA	NA	NA	OK	NA	NA	NA	NA	NA
	1.3	NA	NA	NA	OK	NA	NA	NA	NA	NA
	2.0	NA	NA	NA	OK	NA	NA	NA	NA	NA
	2.1	NA	NA	NA	OK	NA	NA	NA	NA	NA
	2.2	NA	NA	NA	OK	NA	NA	NA	NA	NA

OK Feature available in INCA
NA Not applicable
NS Not supported

Available with INCA V7.2 SP11

INCA V7.2 – What's New

Standards



AUTOSAR – Support of V4.1 / V4.2 / V4.3.x for XCP on Flexray

Beside the Fibex files also the Autosar files describe the controller settings for the XCP on FlexRay controllers.

INCA supports now the configuration of XCP on Flexray controllers additionally by Autosar description file.

This allows the user to configure the devices automatically independent whether he uses Fibex or Autosar description files.

[Available with INCA V7.2 SP12](#)

INCA V7.2 – What's New

Standards



Autosar – File Reparsing

INCA shows now the status of the Autosar elements in the database. The yellow warning overlay icon shows that the data is not parsed with the current converter.

The user can see which elements have to be re-parsed before INCA will use them.

Implicit reparsing is executed if a used workspace uses such an Autosar element.

Explicit reparsing for a specific Autosar file entry or for all Autosar file entries can be started via context menu.

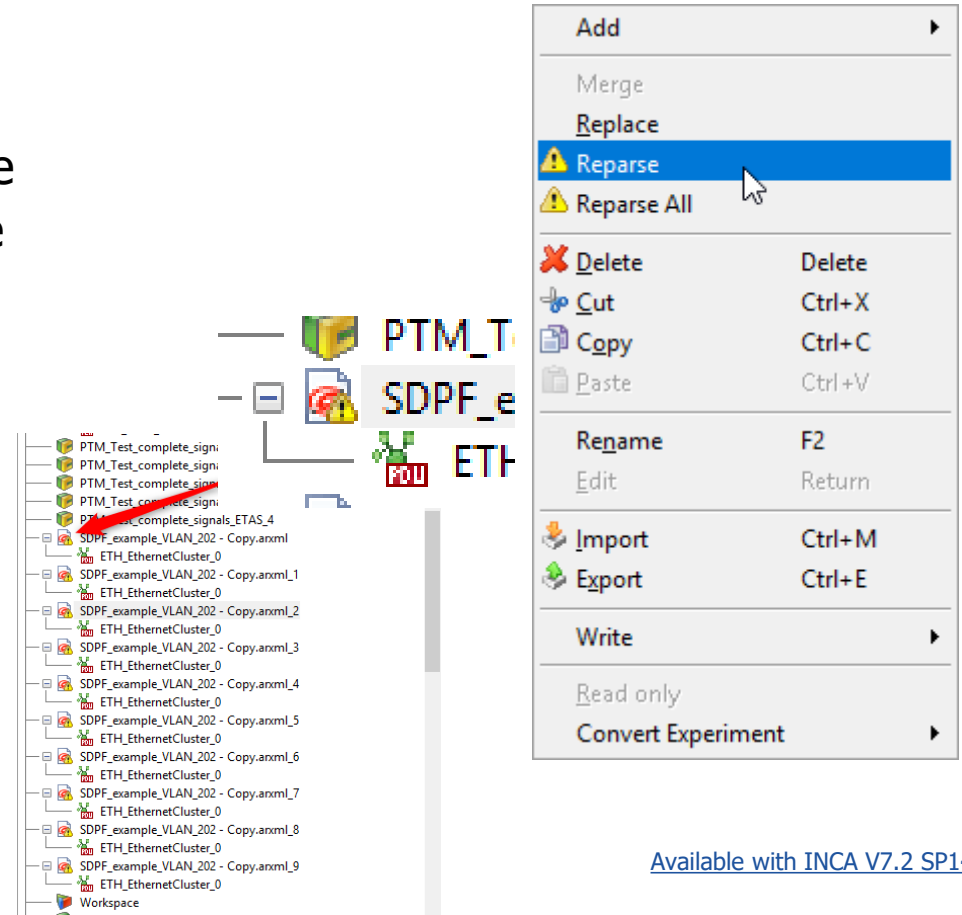

Available with [INCA V7.2 SP14](#)

INCA V7.2 – What's New

Standards



XCP – AUTOSAR Single Pointer Method via XCP protocol

With this calibration concepts INCA is able to emulate calibration data on working page dynamically. The calibration groups are defined in the a2l file and will be accessed from the ECU via pointer table which is located in RAM. With this approach calibration is possible with limited emulation RAM without flashing. The number and size of groups are flexible so that different use cases can be supported. All needed information to support this calibration concept are part of the a2l file.

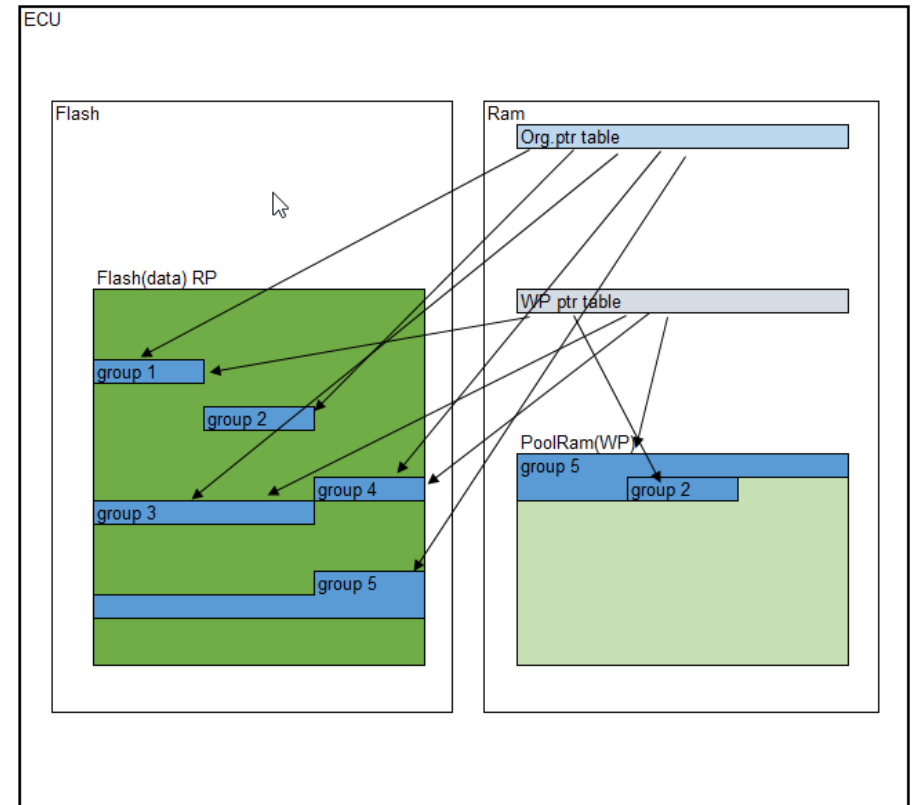

Available with INCA V7.2 SP14

INCA V7.2 – What's New

Standards



XCP - Support of new AML V1.4 / V1.5

ASAM released XCP V1.4 and V1.5.

With the new XCP versions the AML description format (IF_DATA) was changed.

ECU projects like to use the new description format in the A2L files. INCA accepts the new AML description format.

Note: *Only the XCP V1.4 / V1.5 format is supported. Support of new XCP functionality will follow later*

[Available with INCA V7.2 SP10](#)



XCP V1.3 – Time Correlation / Time Synchronization

- with XCP V1.3 / V1.4 / V1.5 it is now possible to improve the time correlation / synchronization between different devices that do not support the ETAS synchronization mechanism
- 3rd party HW with IEEE1588/PTP support and synchronized / synchronized clocks (grandmaster clock)
- INCA reads always clock description from ECU and not from a2l file
- Support based on Szenario3 of the XCP specification

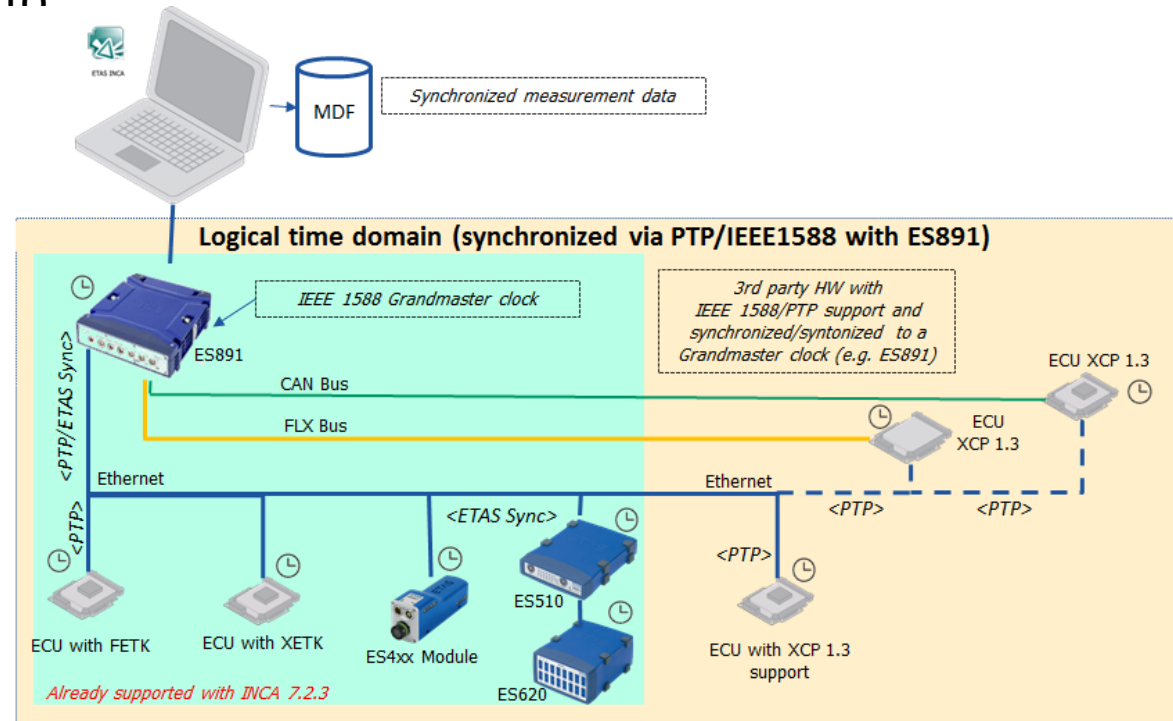

Available with INCA V7.2 SP11

FETK/XETK use an ETAS specific synchronization mechanism



XCP V1.4 – PACKET_ALIGNMENT_x – Packet Alignment for Ethernet

For a better performance and an aligned access in the XCP slave to the xcp messages within an Ethernet frame the Packet Alignment was introduced for XCP on TCP/IP and UDP/IP.

INCA supports this feature by setting the corresponding parameter in the a2I file.

The aligning is performed by optional FILL bytes within the tail.

When sending messages, INCA will always add the tail to each TCP or UDP message.

When receiving messages, the tail is optional for single UDP messages only.

[Available with INCA V7.2 SP12](#)



XCP V1.4 – ERR_TIMECORR_STATE_CHANGE - Additional error code for start/stop DAQ

With XCP V1.4 a new error code `ERR_TIMECORR_STATE_CHANGE` was defined in the XCP specification for the commands `START_STOP_DAQ_LIST` and `START_STOP_SYNCH` which is relevant for the usage of the `TIME_CORRELATION_PROPERTIES` command.

With this error code the slave can inform the XCP master about any change of the clocks since the last upload of the information.

[Available with INCA V7.2 SP12](#)



XCP V1.4 – START_STOP_SYNC – Enhancement of Command

To improve the start of measurements for the XCP slave the master sends a START_STOP_SYNCH command (with mode=3) direct before START_STOP_SYNCH command (with mode=1).

With this new command the master indicates the slave that there will no change anymore in the DAQ configuration.

The error handling is implemented as it is described in the XCP specification.

```
XCP-Packet: FREE_DAQ
XCP-Packet: ALLOC_DAQ
XCP-Packet: ALLOC_ODT
XCP-Packet: ALLOC_ODT_ENTRY
XCP-Packet: SET_DAQ_PTR
XCP-Packet: WRITE_DAQ_MULTIPLE
XCP-Packet: SET_DAQ_LIST_MODE
XCP-Packet: START_STOP_DAQ_LIST
XCP-Packet: TRANSPORT_LAYER_CMD
XCP-Packet: GET_DAQ_CLOCK
XCP-Packet: START_STOP_SYNCH (mode3) New
XCP-Packet: START_STOP_SYNCH (mode1)
XCP-Packet: TIME_CORRELATION_PROPERTIES
XCP-Packet: UPLOAD
XCP-Packet: UPLOAD
XCP-Packet: GET_DAQ_CLOCK
XCP-Packet: GET_STATUS
XCP-Packet: START_STOP_DAQ_LIST
XCP-Packet: START_STOP_SYNCH
```

[Available with INCA V7.2 SP12](#)



XCP V1.4 – Support of Packed DAQ Lists (DAQ Packed Mode)

Target: Reduce the number of interrupts of the controller/ECU and measure with faster Events.

Reduce overhead → optimization of busload.

Support for CAN-FD/Ethernet communication for static DAQ lists.

Support of element-grouped and event-grouped packed mode.

EVENT cycle time down to 1μs supported.

PID 0	00:03	A3	B3	C3	D3	E3	F3
PID 1	G3	H3	J3	K3	L3	M3	

Figure 8 Standard DTO format

PID 0	00:03	A0	A1	A2	A3	B0	B1	B2	B3	C0	C1	C2	C3	D0
		C3	D0	D1	D2	D3	E0	E1	E2	E3	F0	F1	F2	F3
PID 1	G0	G1	G2	G3	H0	H1	H2	H3	J0	J1	J2	J3	K0	
	J3	K0	K1	K2	K3	L0	L1	L2	L3	M0	M1	M2	M3	

Figure 9 DTO format in element-grouped packed mode.¹

PID 0	00:03	A0	B0	C0	D0	E0	F0	A1	B1	C1	D1	E1	F1	A2
		F1	A2	B2	C2	D2	E2	F2	A3	B3	C3	D3	E3	F3
PID 1	G0	H0	J0	K0	L0	M0	G1	H1	J1	K1	L1	M1	G2	
	M1	G2	H2	J2	K2	L2	M2	G3	H3	J3	K3	L3	M3	

Figure 10 DTO format in event-grouped packed mode.¹

Available with INCA V7.2 SP13

Figures taken from XCP specification V1.4

INCA V7.2 – What's New

Standards



XCP – IPv6 support for INCA

An a2l file can contain either an IPv4 or an IPv6 address for TCP or UDP in a transport layer instance as communication parameter.

INCA shows now either an IPv6 or an IPv4 parameter field in the HWC with the given parameter from the a2l file or for manually configuration.

Which kind of IP version will be shown is linked to the a2l description.

Search for IPv6 slaves is not supported.

The screenshot shows the INCA software interface. The top menu bar includes 'File', 'Hardware', 'Device', 'Channels', 'View', and 'MCE'. Below the menu is a toolbar with various icons. The main window is divided into two panes. The left pane, titled '1 Hardware devices', shows a tree view with 'HWK Workspace' expanded to 'Ethernet-System:1', which contains 'XCP:1' and 'ECU OFF/No init./no ECU access'. The right pane, titled '2 Parameters 3 Info', shows the configuration for 'XCP:1'. It includes a table of parameters and their values.

Option	Value
Name	XCP:1
Meas. failure behavior	Abort after failure
Time stamp quantization	Off
Connection behavior	Reinitialize automatically
Project working data	DEFAULT\XCP14onTCP_IPv6 Root\Empty Dataitem_1
Reference data	Root\Empty Dataitem
Differences (bytes)	0
Transport Layer Instance	dummyTLname
Ethernet Address (IPv6)	2001:db38:85a3:8d33:1319:8a2e:3730:7348
Ethernet Port	900
Ethernet Protocol Type	TCP-IP
Log out behavior	No Automatic Flash Back

```
/****** start of TCP_IP *****/
struct TCP_IP_Parameters {
    uint; /* XCP on TCP_IP version */
    uint; /* "1.4" = 0x0104 */
    uint; /* PORT */

    taggedunion {
        "HOST_NAME" char[256];
        "ADDRESS" char[15];
        "IPV6" char[39];
    };
};
```

Available with INCA V7.2 SP13

INCA V7.2 – What's New

Standards



FlexRay data from Autosar Description File V4.1/V4.2

INCA supports Autosar Bus description files for FlexRay Monitoring

INCA imports all FlexRay and CAN clusters from the Autosar file

The clusters can be used to configure the connected FlexRay and CAN hardware

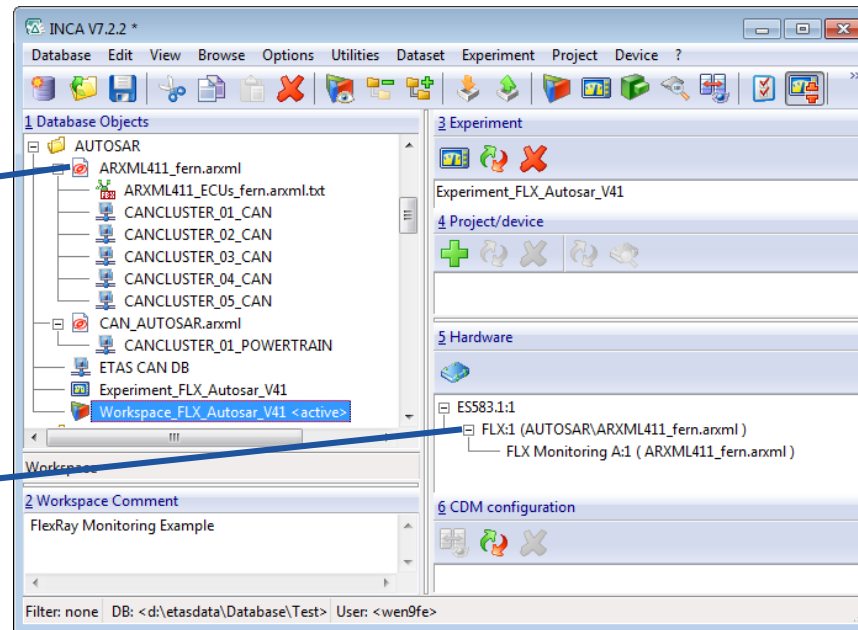

Available with INCA V7.2 SP2

INCA V7.2 – What's New

Standards



AUTOSAR V4.3 - CAN FD & FlexRay

INCA support AUTOSAR v4.3 with the functional scope as V4.2.2 for CAN/CAN FD and FlexRay monitoring.

Following special AUTOSAR features are supported:

- Monitoring of **Container I-PDU (Multiple PDU to Container)** on CAN FD
- **Monitoring of Secure on Board Communication (SecOC)** on CAN FD
INCA supports measurement and recording of signals defined in Secured I-PDUs



[Available with INCA V7.2 SP7](#)

INCA V7.2 – What's New

Standards



PROF Diagnostic on IP (DoIP) Flashing

1. PROF now supports DoIP flashing (UDS on Ethernet) according to ISO13400-2 for ECUs with **static IP address**
 - Use XCP on Ethernet in INCA HWC for measurement and calibration
 - Open the Memory Page Manager to start flashing as usual
 - Select a PROF configuration for DoIP flashing
2. The CNF file of a DoIP PROF configuration requires just three new parameters for DoIP (compared to a UDS on CAN PROF configuration):
 - DOIP_IP_ADDRESS
 - DOIP_SOURCE_ADDRESS
 - DOIP_TARGET_ADDRESS(updated PROF Documentation available)

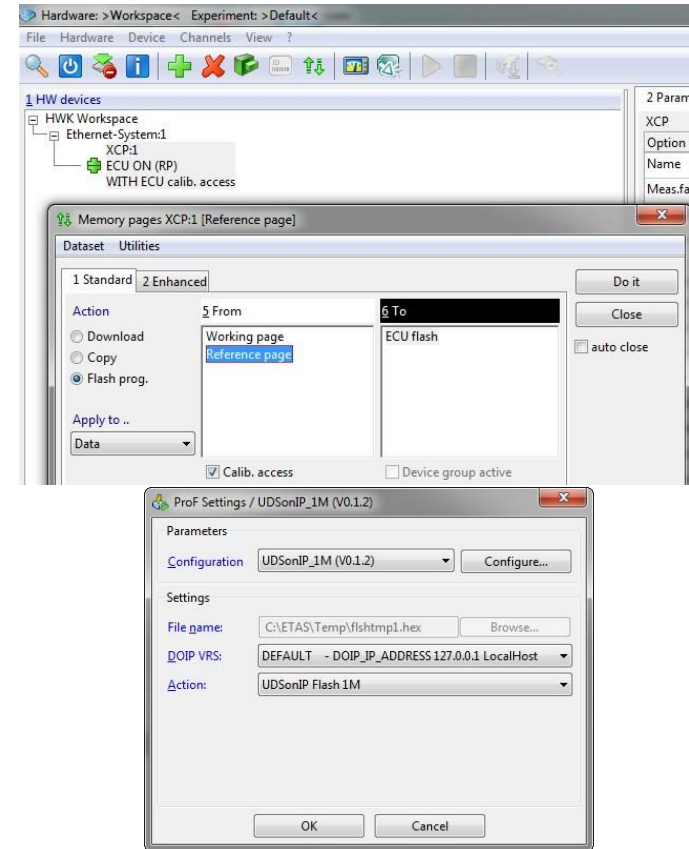

Available with INCA V7.2 SP3



PROF XCP Flashing – New XCP_SET_TIMEOUT Command

For XCP flashing, PROF uses the XCP connection that has been established based on the XCP parameters from A2L. These parameters are optimized for the XCP measurement and calibration use cases, but not for flashing.

During flashing, some actions have to be performed that take a long time to process, e.g. erasing of the ECU memory or checksum verification. If using the optimized low XCP timeouts $t_1 - t_7$ from the A2L file, the XCP communication could run into timeouts during flashing.

Up to now, it was not possible to use different XCP timeout parameters for flashing. This is now possible by using the new PROF command `XCP_SET_TIMEOUT`!

The new command allows to change the individual $t_1 - t_7$ timeouts during flashing and thereby avoids to run into timeouts during flashing.

The new command is documented in the PROF documentation.

[Available with INCA V7.2 SP8](#)



PROF – Full Support of DoIP Flashing

New CNF parameters for DoIP flashing

- **DOIP_IP_ADDRESS**
 - Static ECU IP address as string (either V4 or V6 format), e.g. "192.168.0.100"
- **DOIP_SOURCE_ADDRESS**
 - 16-bit source address of the UDS message sender (INCA), e.g. "0x0E00"
- **DOIP_TARGET_ADDRESS**
 - 16-bit target address of the UDS message receiver (ECU), e.g. "0xE000"
- **DOIP_ENTITY_IDENTIFICATION**
 - 6 Byte DoIP entity identification (EID) that uniquely identifies a DoIP ECU
- **DOIP_SUBNET_ADDRESS**
 - Subnet prefix address that is used by the DoIP network that contains the ECU to be flashed (either in V4 or V6 prefix notation), e.g. "192.168.40.0/24" or "2001:db8:abcd:0012::0/64" (the number behind the slash defines the number of prefix bits that are relevant for the subnet).

[Available with INCA V7.2 SP6](#)



PROF – Flashing up to 255 Memory Segments

In the past, PROF only supported up to 20 memory segment definitions in the CNF file of a PROF configuration.

Starting with SP9, PROF now supports up to 255 segments for all memory segment definitions:

- DEST_MEM_AREA
- SOURCE_MEM_AREA
- ERASE_MEM_AREA

The new functionality is documented in the PROF documentation:

The screenshot shows a documentation page for the `DEST_MEM_AREA` keyword. The text explains that this keyword defines programming areas in flash memory and other data areas in the control unit. A key update is highlighted: "Up to 255 different memory areas can be defined in the CNF file." The documentation also provides the syntax for the keyword: `DEST_MEM_AREA: , <index>, <memoryType>, <transferType>, <startAddr>, <endAddr>;` and lists parameters: `index, memoryType, transferType, startAddr, endAddr` with a reference to the `SOURCE_MEM_AREA` documentation. A note states: "The memory areas defined here can be accessed for reading or writing. The RB-AK flash requires that the memory type be specified in bits 23 ... 20 of the target address when programming the flash memory. This can be used to specify whether to access flash EPROM, internal RAM, external RAM, etc. The end address always refers to the last memory cell to be erased or written and has to be odd-numbered - at least for 16-bit CPUs." An example line of code is shown: `DEST_MEM_AREA: , 1, 0x00, 0x00, 0x00000L, 0x1FFFFFFL;`. A "Since" section is highlighted with a green box, stating: "Until INCA 7.2.9, up to 20 memory areas were supported only."

[Available with INCA V7.2 SP9](#)



PROF – UDS messages up to 64kByte for CAN-FD and DoIP flashing

With previous INCA versions the maximum UDS message length was limited on INCA side to 4kByte.

With the introduction of CAN-FD and IP transport layers, ECU suppliers started to increase the UDS message size limit on ECU side.

PROF now supports UDS messages up to 64kByte for CAN-FD and DoIP flashing. But PROF uses larger messages only, if

- it is supported by the ECU (requestDownload response parameter) and
- it is not limited by the MAX_LENGTH and AALFI parameters in the PROF script and
- the used HW device supports larger messages

With SP10, the USB devices ES582 and ES584 support 64kByte messages. Further ETAS devices will be updated later (HSP update needed).

[Available with INCA V7.2 SP10](#)



ProF – Support spaces in paths and none-8dot3 path format for ProF flashing

With previous INCA versions, ProF flashing could fail when using path names with spaces or special characters for the ProF config installation path or the hex file path.

Most customers solved this issue by activating the 8dot3 path notation of Windows, which shortens path names and removes spaces and other special characters:

`C:\ETASData\My Prof Configurations\UDSonCAN_StdID_ExtAddr_1MBaud` → `C:\ETASDATA\MYPROF~1\UDSONC~1\` (8dot3 path)

ProF now supports Windows compliant paths with spaces, special characters and up to 259 characters of length with and without active 8dot3 notation!

But switching a PC from 8dot3 mode to none-8dot3 mode or vice versa is not supported for already installed ProF configs! Installed ProF configs can only be used in the same 8dot3 mode (either on or off) as it was configured during installation of the ProF config.

In addition, not all customer ProF configs itself support paths with spaces, e.g. if customer specific DLLs called within the config do not support spaces or if paths with spaces, commas, brackets or other special characters are used without quotation marks! -> Customers need to check their ProF configs, before switching off 8dot3!

INCA V7.2 – What's New

Standards



ASAP2 Container

The ASAM standardized container combines A2L, HEX, CDF and other files

The user can select which files to read in

INCA extracts*) the selected files into its database

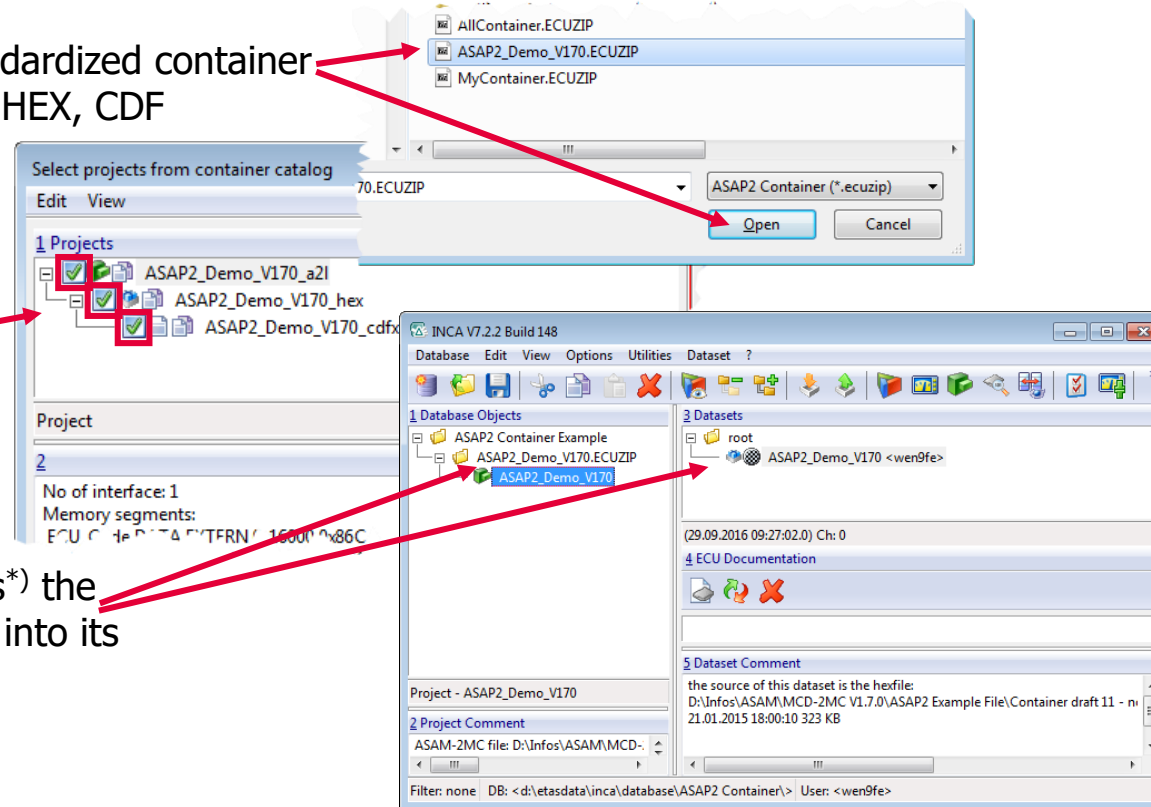

*) INCA needs 7ZIP installed

Available with INCA V7.2 SP3



ASAP2 – Disable Download for OFFLINE_DATA

To get consistent ECU data memory segments can be described as OFFLINE_DATA. This ensures that all calibration changes are written to the ECU with one download.

New Multi Core ECU may have memory segments with calibration data that are not always accessible.

In this case calibration is only offline possible. Additionally, a download is not allowed too. All changes in these segments have to be flashed.

INCA supports for this use case the description OFFLINE_DATA ROM

MEMORY_SEGMENT program type	MEMORY_SEGMENT memory type	Checksum	Online Calibration	Offline Calibration	Upload	Download	Flashing
OFFLINE_DATA	FLASH	yes	no	yes	yes	yes	yes
OFFLINE_DATA	ROM	yes	no	yes	yes	no	yes

[Available with INCA V7.2 SP9](#)



ASAP3 V3.0 – Extended Commands for Measurement & Calibration

ASAP3 V3.0 improves calibration handling.

INCA supports the new ASAP3 V3.0 commands

GET CALPAGE INFO
GET CURRENT CALPAGE
SET CURRENT CALPAGE



- Info over available pages
- Active page switching

GET CHARACTERISTIC INFO
READ CHARACTERISTIC
READ CELL VALUES
WRITE CHARACTERISTIC
WRITE CELL VALUES



- Covers all characteristic types defined in ASAP2
- Reading and writing of implementation and physical values

[Available with INCA V7.2 SP12](#)

INCA V7.2 – What's New

Standards



ASAP3 V3.0 – Extended Commands for Measurement & Calibration

INCA supports the new ASAP3 V3.0 commands

GET RASTER OVERVIEW
GET MEASUREMENT INFO



Info over all raster
and available raster

PARAMETER FOR VALUE ACQUISITION EV2
GET ONLINE VALUE EV2
DEFINE RECORDER PARAMETER



Assign concrete raster

SET FORMAT



Switch calibration values between physical and ECU
internal value

[Available with INCA V7.2 SP13](#)

INCA V7.2 – What's New

Standards



ASAP2 – Transfer Keyword **SYMBOL_LINK** in MDF File

INCA adds the **SYMBOL_LINK** info to the MDF file. MDA 8 shows it in the Signal Explorer.

The image shows two screenshots from the INCA software. The left screenshot displays the 'About Variable' dialog for 'Input_1\ETK test device:1'. The 'Property' table includes a 'Symbol link' property with the value '@@_Input_1 0x70'. The right screenshot shows the 'Signal Explorer' window with a table of signal data. A red box highlights the 'Symbol Link Name' and 'Symbol Link Offset' columns, which contain values like '@@_B_GREEN', '@@_B_RED', and '@@_Input_1'. A central icon labeled 'MDF V4' with a magnifying glass over a waveform is connected to both screenshots by red arrows, indicating the transfer of this information to the MDF file.

Name	Symbol Link Name	Symbol Link Offset
\$ActiveCalibrationPage	No Data	No Data
\$CalibrationLog	No Data	No Data
\$EVENT_COMMENTS	No Data	No Data
B_GREEN	@@_B_GREEN	2
B_RED	@@_B_RED	0
B_YELLOW	@@_B_YELLOW	1
Input_1	@@_Input_1	112
Input_2	@@_Input_2	112
MEASURE_T04	@@_MEASURE_T04	0
MEASURE_T05	@@_MEASURE_T05	0
MEASURE_T06	@@_MEASURE_T06	0
	@@_Output	1

Available with INCA V7.2 SP9

INCA V7.2 – What's New

Overview

1. Product information (Use cases, Sample applications, Customer value)

- Performance
- Functionality
- Standards
- Usability
- **HW support**
- Add-ons

2. INCA Product Family

3. Phase out information

4. General Notes



INCA V7.2 – What's New

HW support



ES89x Interfaces

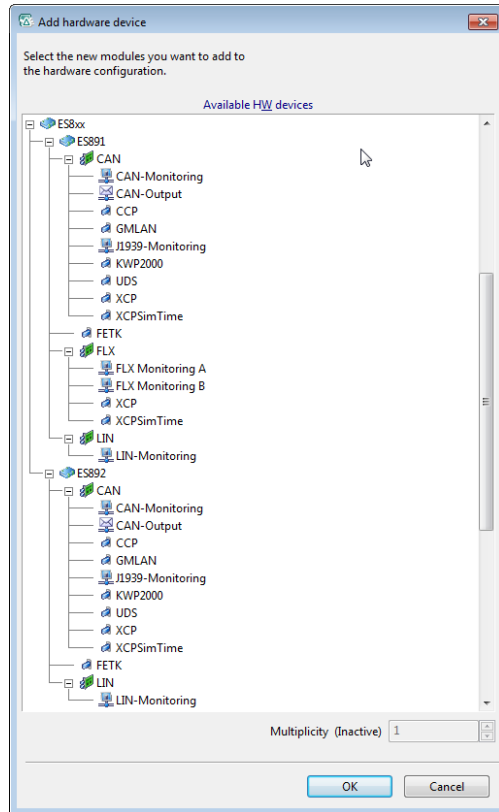

ES891 / ES892



Feature	Characteristic
System performance per FETK link	More than 38,000 signals or 17 MB/s data from the ECU into INCA
No. of high-performance FETK interfaces on ES891 / ES892	2
Bus interfaces on ES891 / ES892	3 CAN(-FD), 1 LIN, 1 FLX (A/B) ^{only ES891} Reconfigurable to 1 LIN, 5 CAN(-FD)
Raster speed	Down to 5 μ s
RP/bypassing latency (FETK-T)	170 μ s (32 Byte / 5 μ s)
Time synchronization with other interface/measurement hardware via IEEE1588	<1 μ s

INCA V7.2 – What's New



HW support

ES886 – INCA integration

New generation of ECU and bus access module

- Stacking concept for easy extension with further modules using a high-speed interconnect system
- Simultaneous access to multiple ECUs and a variety of busses
- MCD, Flash Programming, Rapid Prototyping
- Direct access to **BR_XETK** or **Automotive Ethernet**
- Time Synchronization at all interfaces
- **IEEE1588/PTP** support
- Ready for **internal TAPing** and **SOME/IP Monitoring** that will be supported by INCA in a future version.



Support of following interfaces in INCA

- 1 x 1000Base-T Gigabit Host/PC connection towards INCA
- 1 x 100Base-T Fast Ethernet (for ETAS legacy devices)
- 4 x 100Base-T1 Automotive Ethernet (3x for BR_XETKs + 1x currently not in use)
- 1 x 1000Base-T Gigabit Ethernet (for ETAS ES8xx devices)
- 5 x CAN/CAN FD
- 1 x LIN

[Available with INCA V7.2 SP9](#)

INCA V7.2 – What's New

HW Support



ES886 – Extensions

- Enables capturing on up to 4 Ethernet interfaces in parallel with time synchronization.
- Any of the 100Base-T1 (AE1-4), GE or FE can be configured for Ethernet capturing.
- Enables up to 2x internal TAP (AE1-2, AE3-4)
- Ethernet Monitoring of AUTOSAR PDU based or SOME/IP signals
- Automatically configuration of 1st stage HW filter (VLAN)

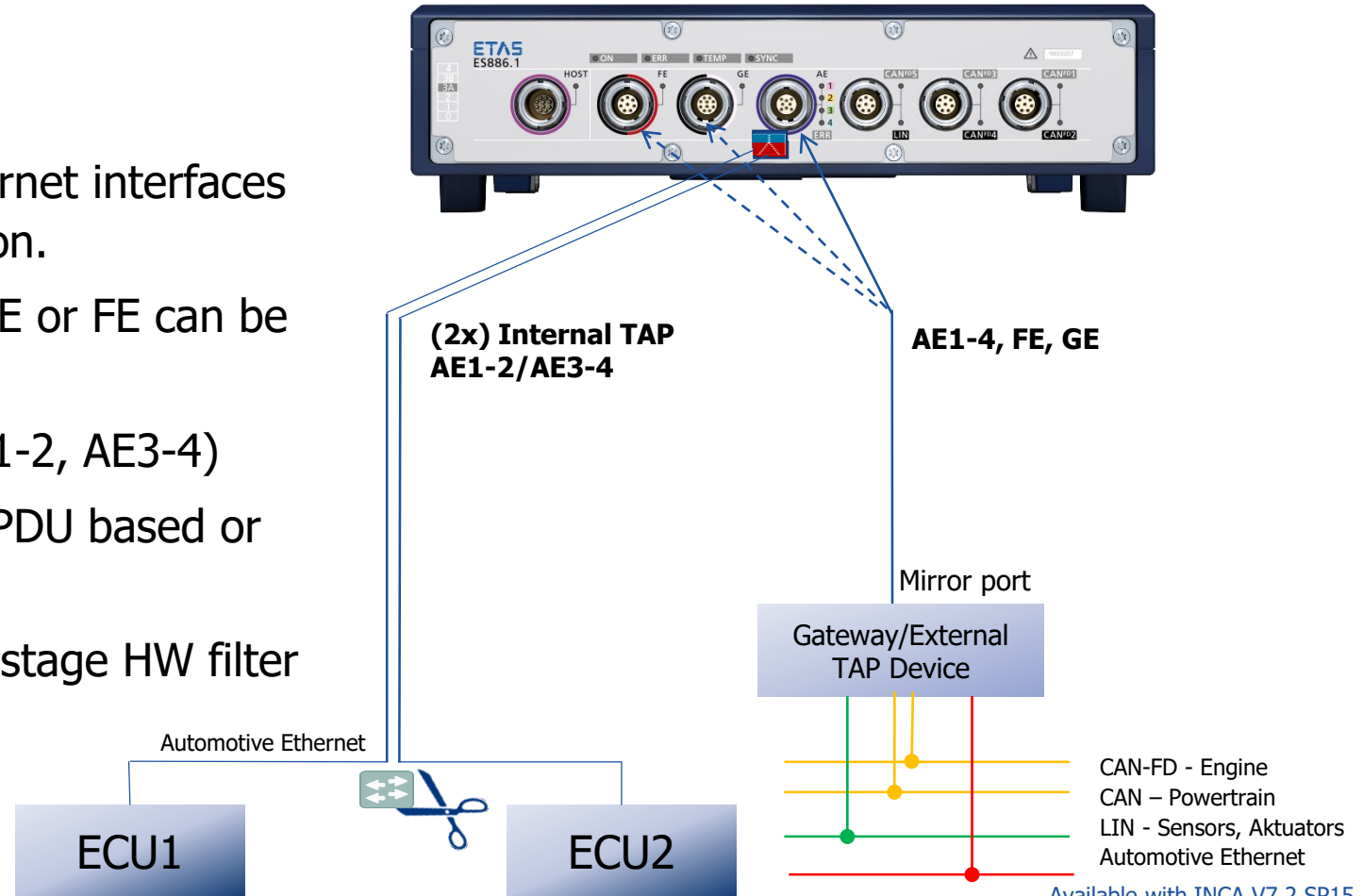

INCA V7.2 – What's New

HW support



VN5610/A – Support for Automotive Ethernet & BR-XETK

Support as Ethernet monitoring capture device.

Support as Ethernet monitoring tapping device.

Support as media converter.

Support of 2 CAN/CAN-FD ports for XCP, KWP2000
UDS, CCP, CAN-Monitoring...

INCA enable bit (F-00K-112-085) has to be ordered
to use the HW in INCA.

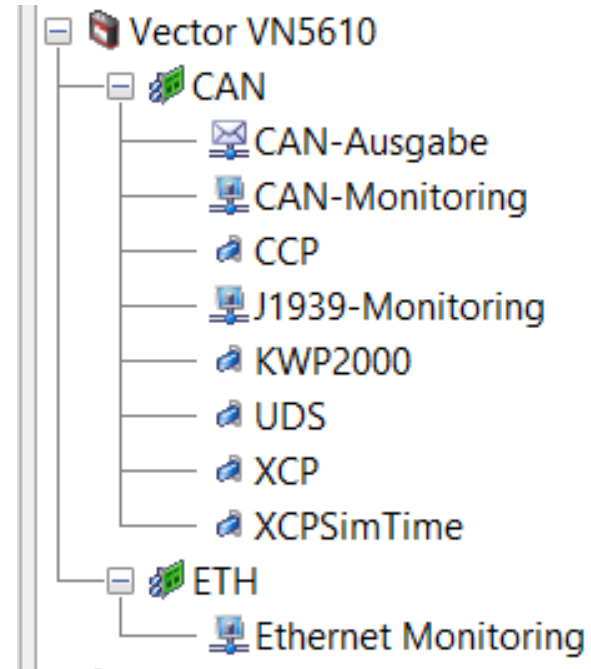

[Available with INCA V7.2 SP13](#)

INCA V7.2 – What's New



HW support

CAN FD Support for Vector VN Devices

INCA 7.2 supports now CAN FD for already supported Vector VN modules:
VN1610, VN1611, VN1630/VN1630A, VN1640/VN1640A and VN8970



Uses cases supported on CAN FD bus:

- CAN FD Monitoring
- UDS on CAN FD (ISO14229 on ISO15765-2 from 2013-10-22)
- UDS on CAN FD flashing with INCA-ProF
- XCP on CAN FD
- XCP Flash on CAN FD
- CAN FD Frames sending with ProF

[Available with INCA V7.2 SP9](#)

INCA V7.2 – What's New

HW support

VN7610 Support

The VN7610 is an USB to FlexRay/CAN/CAN-FD hardware

INCA 7.2 SP2 supports following interfaces:

- 1 x FlexRay (Channel A and B) with 1082cap Transceiver
- 1 x CAN High-Speed / CAN-FD with 1051cap Transceiver

Interfaces CAN/CAN-FD and FLX are supported in parallel using a FX/CANcable (2Y cable)

CAN-FD capabilities of this device are also supported in INCA



[Available with INCA V7.2 SP2](#)



INCA V7.2 – What's New

HW support

ES582.1 – INCA Integration

The ES582.1 is an USB to CAN/**CAN FD** (flexible data-rate) hardware.

The new ES582.1 module is a compact, cost effective dual-channel CAN FD interface which support up to 5 MB/s for the data transmission und up to 8 MB/s under laboratory conditions.

This device supports non-ISO CAN FD and CAN FD ISO 11898-1 standard. The frame format can be defined in the Hardware Configuration Dialog (HWC) of INCA.

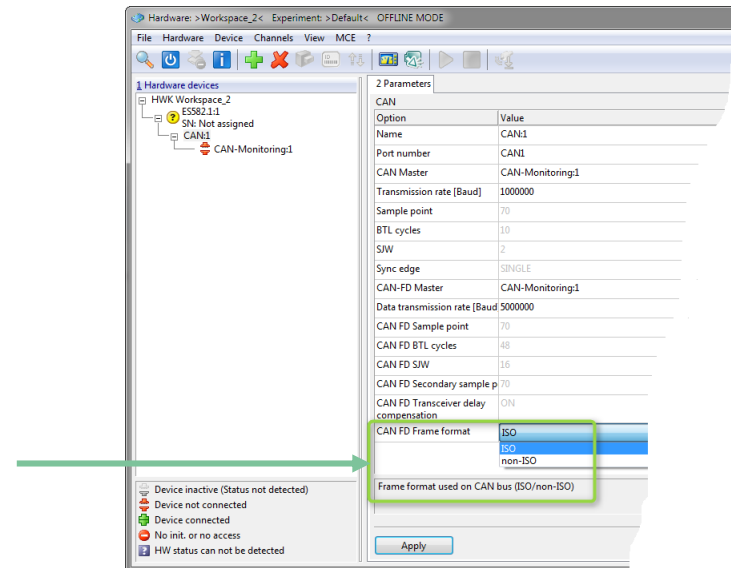
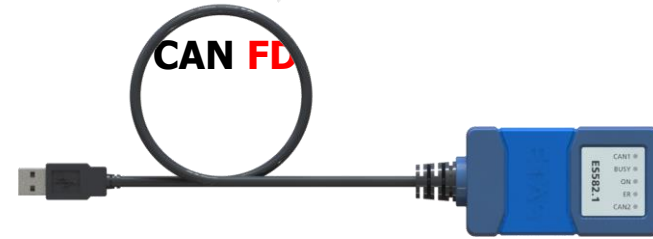

Available with INCA V7.2 SP3



INCA V7.2 – What's New

HW support



ES922 – INCA integration

The ES922 is a **CAN FD** piggy for the **ES910.3**.

ES922 piggy provides 2 x CAN-FD interfaces which can be used in INCA with all CAN FD features like Monitoring, XCP, UDS, ProF.

Support of CAN FD ISO and non-ISO frame format

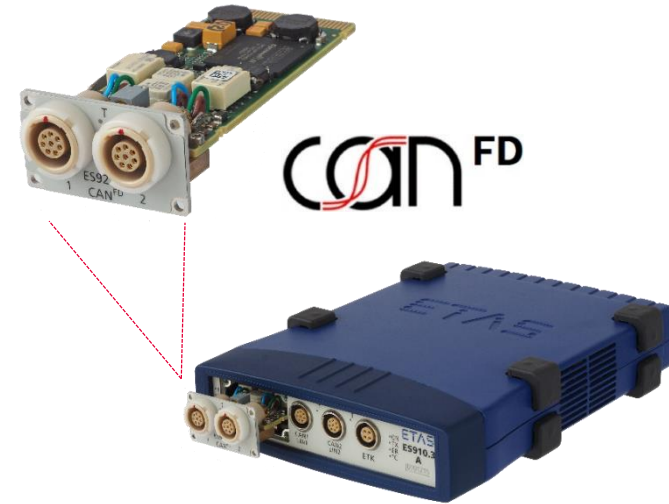

[Available with INCA V7.2 SP6](#)

INCA V7.2 – What's New

HW support



ES584.1 – INCA integration

The ES584.1 is an USB to **CAN/CAN FD** and **LIN** hardware.

Supported interfaces:

- Support of 1 x CAN/CAN-FD channel
- Support of 1 x LIN channel
- Parallel use of both channels requires Y cable
- Support of CAN-FD ISO and non-ISO frame format



[Available with INCA V7.2 SP6](#)

INCA V7.2 – What's New



HW support

ES882 – INCA integration

New generation of ECU and bus access module for:

- Stacking concept for easy extension with further modules using a high-speed interconnect system
- Simultaneous access to multiple ECUs and a variety of busses
- MCD, Flash Programming, Rapid Prototyping
- Direct access to BR_XETK or Automotive Ethernet
- Time Synchronization at all interfaces.
- IEEE1588/PTP support

Support of following interfaces in INCA:

- 1 x 1000Base-T Gigabit Host/PC connection towards INCA
- 1 x 100Base-T Fast Ethernet (for ETAS legacy devices)
- 4 x 100Base-T1 Automotive Ethernet (3x for BR_XETKs + 1x currently not in use)
- 1 x 1000Base-T Gigabit Ethernet (for ETAS ES8xx devices)
- 5 x CAN/CAN **FD**
- 1 x LIN



[Available with INCA V7.2 SP7](#)

INCA V7.2 – What's New



HW support

IEEE 1588 Time Synchronization with ES891/ES892

The time synchronization of ES891/ES892 modules is conform to IEEE1588 standard, facilitating easy integration into heterogeneous test setups and automation solutions with a central clock. INCA improves its time domain management interfaces to provide higher precision of the time synchronization.

Example use case:

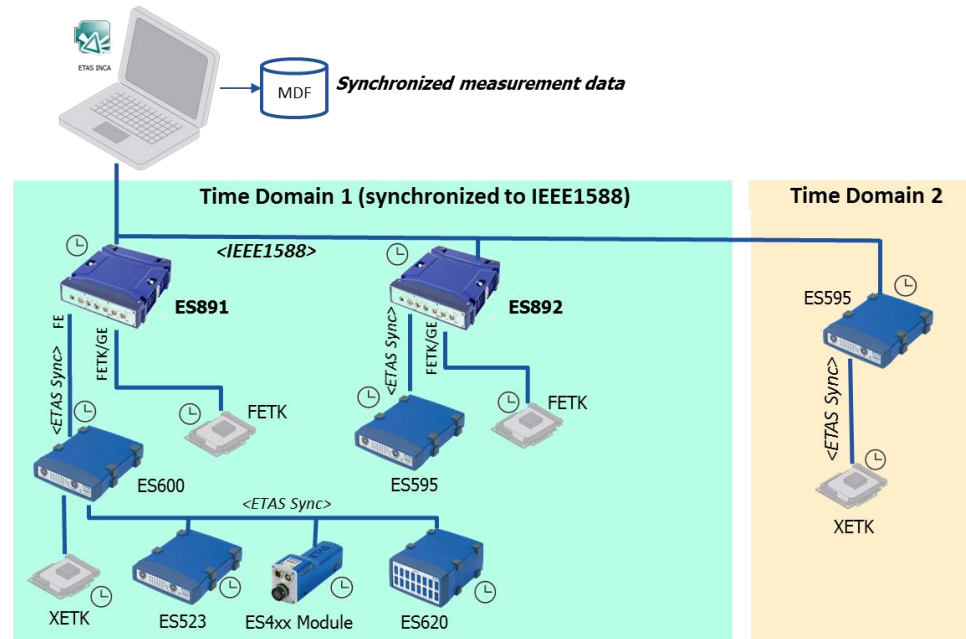

Available with INCA V7.2 SP4

INCA V7.2 – What's New



HW support

Improvement of the Time Synchronization in INCA

In order to support the new device generation ES8xx, the time synchronization mechanism has been improved on all protocols:

- XCP
- FETK
- XETK
- ETK
- CAN/CAN FD monitoring
- FlexRay monitoring
- LIN monitoring
- ES4xx "daisy chain"
- CCP
- UDS
- KWP2000

[Available with INCA V7.2 SP4](#)

INCA V7.2 – What's New

Overview

1. Product information (Use cases, Sample applications, Customer value)

- Performance
- Functionality
- Standards
- Usability
- HW support
- **Add-ons**

2. INCA Product Family

3. Phase out information

4. General Notes



INCA V7.2 – What's New

Add-on MCE



MCE – FETK Support

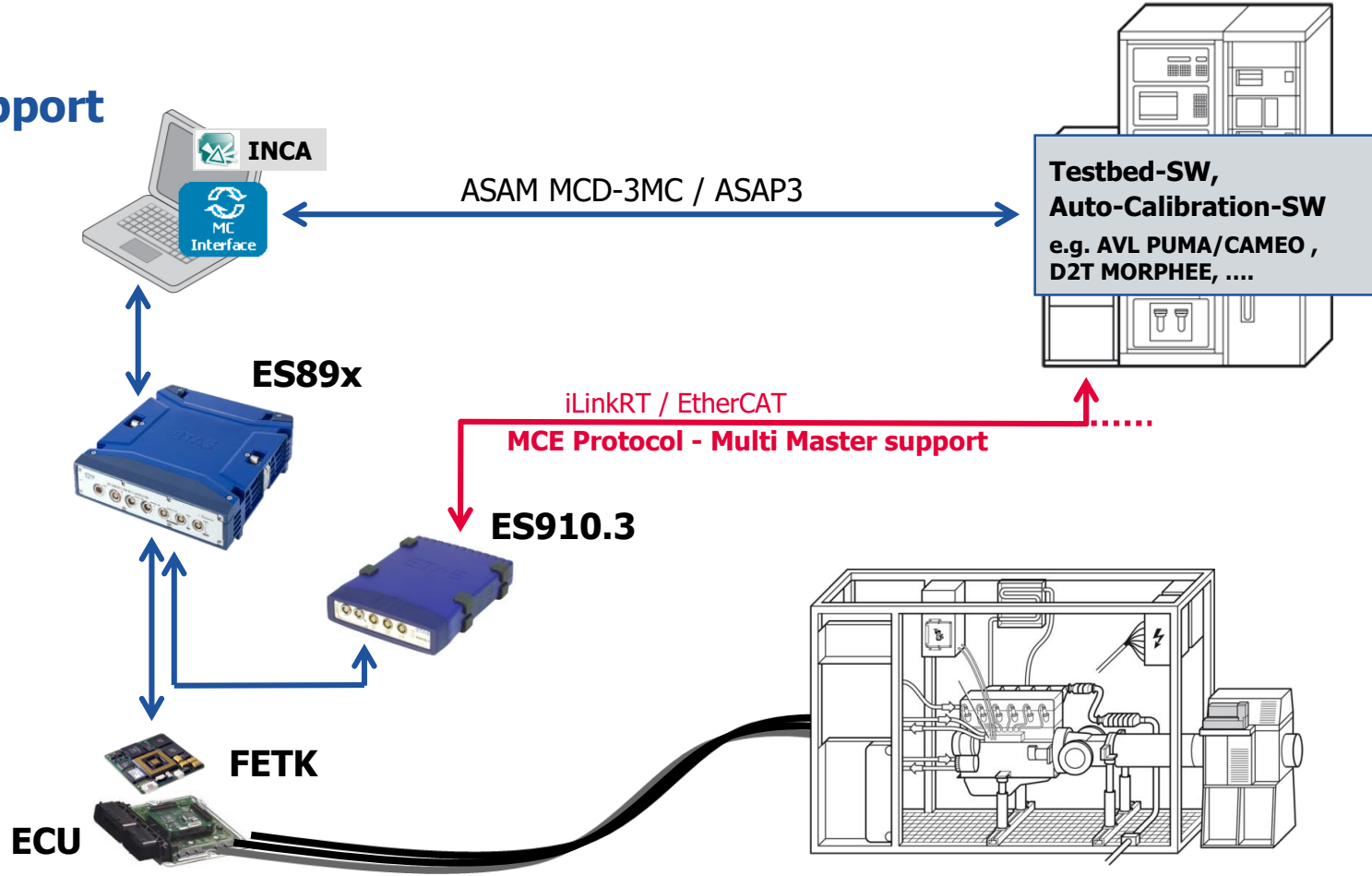

Available with INCA V7.2 SP1

INCA V7.2 – What's New



Add-on MCE

MCE – Variable Selection

The MCE Variable Selection Dialog shows all Measurements & Calibration Variables that are configured for MCE

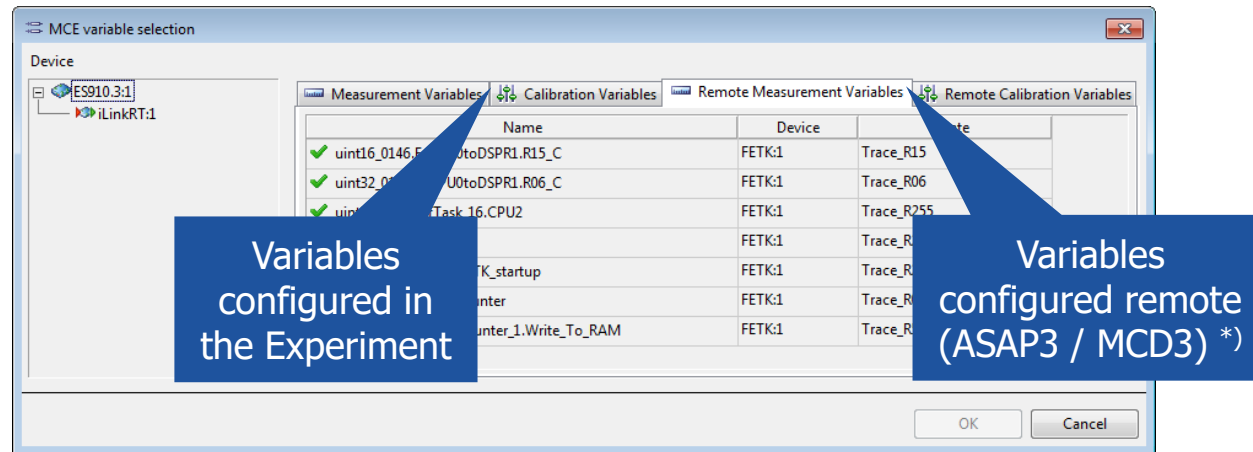

- The Dialog is always available
 - For configuration while measurement is stopped
 - For overview while measurement is running

*) Variables that are configured twice (Experiment & Remote) are in the Experiment lists only

[Available with INCA V7.2 SP1](#)

INCA V7.2 – What's New

Add-on MCE

MCE – Visualization of mapped XETK/FETK

- MCE supports different input devices, for XETK and FETK the user has to assign which XETK/FETK has to work with which ES910.3 manually
- INCA shows an icon in the HWC window to visualize which XETK/FETK and ES910 are already configured
- the user now can see directly if this configuration step was already executed without opening the mapping dialog

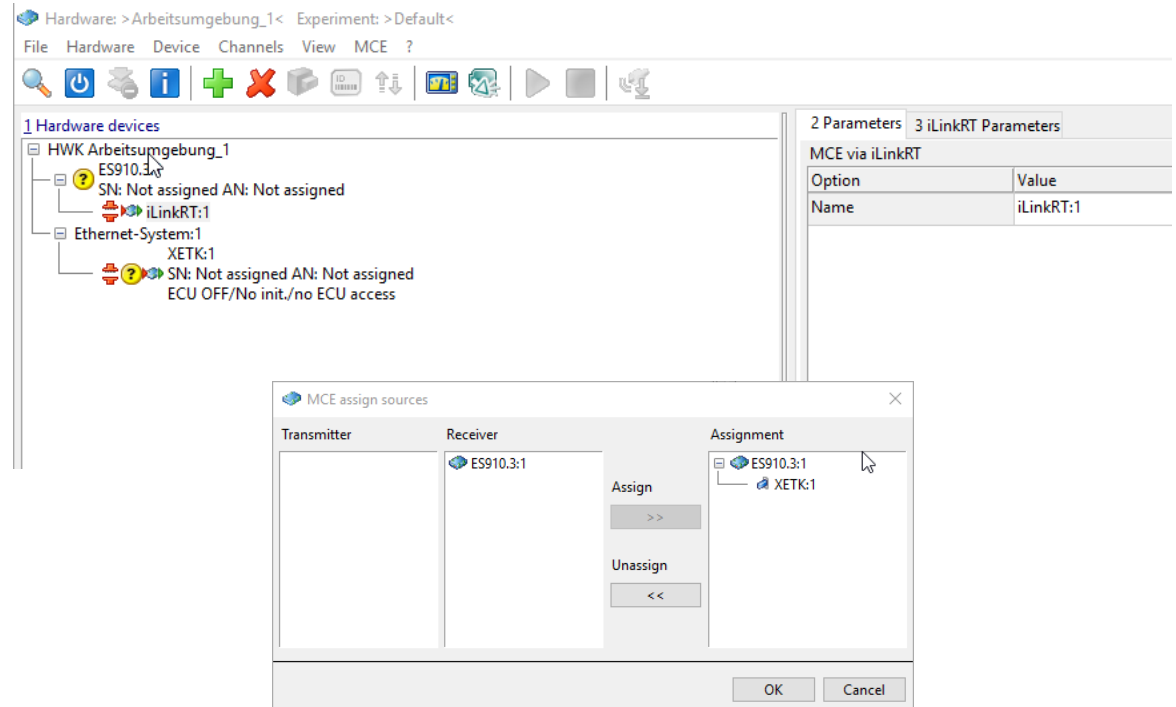

Available with INCA V7.2 SP11

INCA V7.2 – What's New

Add-on Installer



INCA MSI Installer includes Add-ons

- With INCA V7.1 Service Packs ETAS introduced the distribution of INCA updates and Add-ons in one package
 - Ensures consistent installation of INCA and matching add-ons
- With INCA V7.2 INCA and the add-ons will be delivered within separate MSI installations. The INCA Service Pack Installer starts all selected MSI installations
 - The INCA installation will contain
 - MDA *
 - INCA Add-ons * **
 - INCA-EIP (incl. INCA-SIP)
 - INCA-FLEXRAY
 - INCA-LIN
 - INCA-MIP
 - INCA-MCE
 - INCA-ODX
 - INCA-QM-BASIC

* Installation is optional

** requires separate licensing

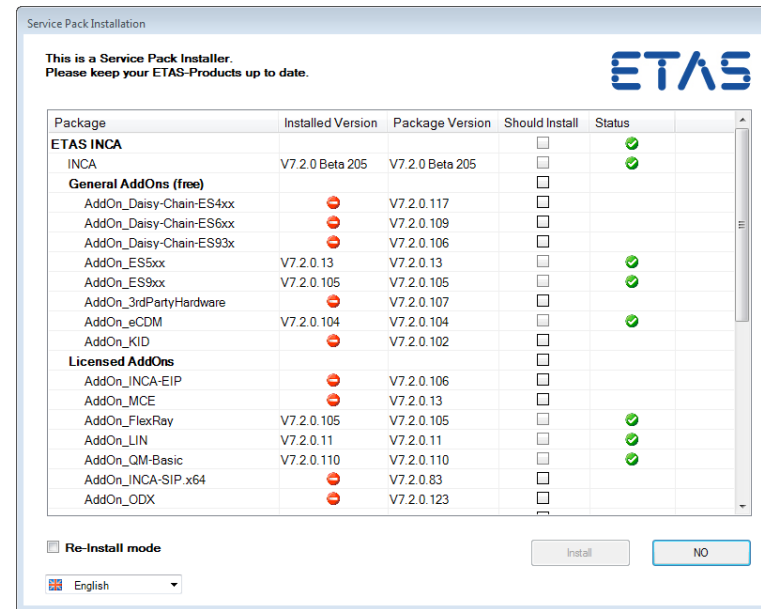

INCA V7.2 – What's New

Add-on SIP

Support of MATLAB

INCA SIP now supports MATLAB 2016a / 2016b

Support of Pre-lookup & Interpolation Blocks

INCA SIP now supports

- Direct Table lookups
 - 1D
 - 2D
 - 3D
 - 4D
- Interpolation Blocks
 - 1D
 - 2D
 - 3D
 - 4D

[Available with INCA V7.2 SP4](#)

INCA V7.2 – What's New

Add-on SIP



INCA-SIP – Remote Operation

- Allows INCA-SIP to connect to an instance of INCA on another machine
- DCOM is used to control INCA remotely from INCA-SIP (configuration might be needed to allow DCOM)
- Both INCA and INCA-SIP need to be installed on both machines to ensure all the needed components can be found on either machine
- A2I and S19 Files are saved on a shared network path (both machines need to access the same folder location given a network or mapped drive path)



[Available with INCA V7.2 SP14](#)

INCA V7.2 – What's New

Add-on SIP



INCA-SIP – Enable 'Connect to INCA' when Model is Running

- Allows users to connect to a model even when the model is already running (or paused)
- INCA-SIP block needs to be present in the model for this to work
- ECU and configuration settings can also be changed when model is running. Changes will take affect on the next connect
- Faster reconnection speeds as model is not compiled again on reconnect

[Available with INCA V7.2 SP14](#)

INCA V7.2 – What's New

Functionality



INCA-SIP – User configurable Hooks for Variable naming and filtering

User custom functions can be set as hooks in INCA-SIP to allow

- custom filtering
- custom measurement & calibration naming
- custom group naming
- in-depth variable customisation, i.e.:
 - set a display identifier
 - change the min- and max-values
 - set the description fields
 - add calibration/measurement labels to additional groups
 - force axis to be COM-axis in the A2L-File

[Available with INCA V7.2 SP15](#)

INCA V7.2 – What's New

Add-on INCA-MIP / INCA-SIP



Support of Matlab

INCA-SIP

- Support of DLL-Mode:
 - INCA-SIP is now able to measure and calibrate variables within a DLL
 - For detailed explanations please look into the INCA-SIP documentation
- Support of Matlab 2017B

INCA-MIP

- Support of Matlab 2017B

[Available with INCA V7.2 SP7](#)

INCA V7.2 – What's New

Add-on INCA-MIP / INCA-SIP



INCA-MIP & INCA-SIP – Support of MATLAB 2018A

INCA-SIP

- Support of Matlab 2018A

INCA-MIP

- Support of Matlab 2018A

[Available with INCA V7.2 SP9](#)

INCA V7.2 – What's New

Add-on INCA-MIP / INCA-SIP



INCA-MIP & INCA-SIP – Support of MATLAB 2018B

INCA-SIP

- Support of Matlab 2018B

INCA-MIP

- Support of Matlab 2018B

[Available with INCA V7.2 SP11](#)

INCA V7.2 – What's New

Add-on INCA-MIP / INCA-SIP



INCA-MIP & INCA-SIP – Support of MATLAB 2019A

INCA-SIP

- Support of Matlab 2019A

INCA-MIP

- Support of Matlab 2019A

[Available with INCA V7.2 SP13](#)

INCA V7.2 – What's New

Functionality



INCA-MIP & INCA-SIP – Support of MATLAB 2019B

INCA-SIP

- Support of Matlab 2019B

INCA-MIP

- Support of Matlab 2019B

[Available with INCA V7.2 SP15](#)

INCA V7.2 – What's New

Add-on INCA-SIP



INCA-SIP supports referenced models

Reference one Model from another Model

You can include one model in another by using [Model](#) blocks. Each instance of a Model block represents a reference to another model, called a *referenced model*. For simulation and code generation, the referenced model effectively replaces the Model block that references it. The model that contains a referenced model is its *parent model*. A collection of parent and referenced models constitute a *model reference hierarchy*.

For example, the `sldemo_mdref_basic` model includes Model blocks that reference three instances of the same referenced model, `sldemo_mdref_counter`

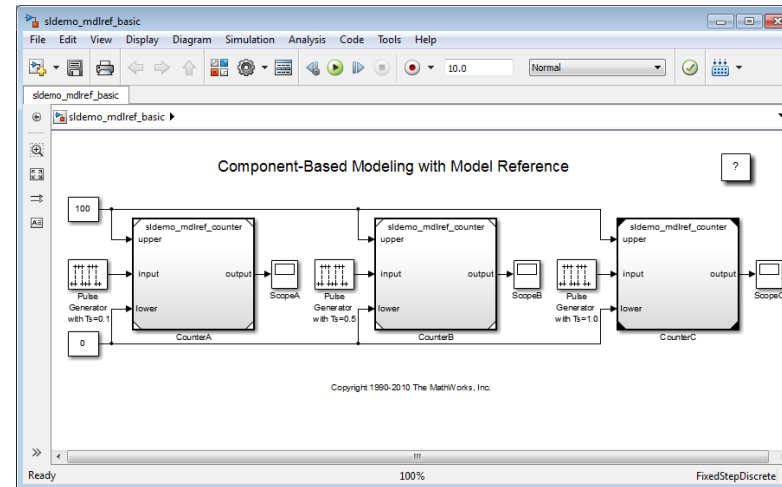

<http://de.mathworks.com/help/simulink/ug/overview-of-model-referencing.html>

Available with INCA V7.2 SP5

INCA V7.2 – What's New

Add-on INCA-SIP



INCA-SIP – Support of mask parameters

- S-Function blocks in Simulink® can have masks that expose certain mask parameters which can be visible in the block dialog when double-clicked

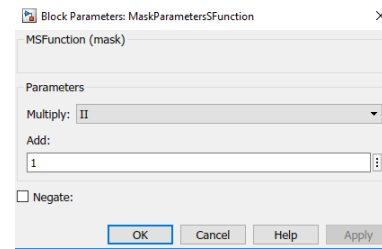
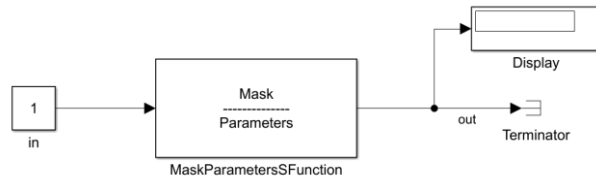

- INCA-SIP now supports the calibration of these parameters for Edit-fields, Checkboxes and Pop-ups with INCA

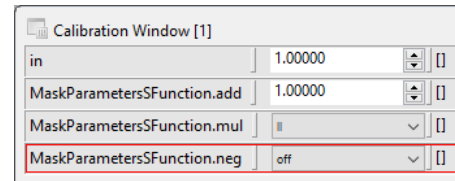
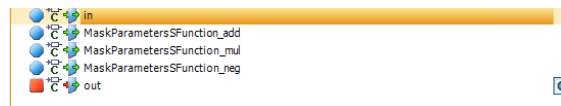

INCA-SIP - Check for correct System Variable before start of INCA-SIP

- Improved user experience in case of an incorrect system variable

Available with [INCA V7.2 SP6](#)

INCA V7.2 – What's New

Add-on INCA-SIP



INCA-SIP

- Real-time Emulation Mode has been extended to support the different Real Time Multipliers
- In Normal and Accelerated Mode it is now possible to measure measurements in a linked library
- MATLAB® Does not need to be executed as an administrator

[Available with INCA V7.2 SP12](#)

INCA V7.2 – What's New

Add-on INCA-SIP



INCA-SIP – Use Workspace Variable in INCA Experiment

With this functionality, the user has the ability to display and calibrate MATLAB® workspace variables in INCA.

[Available with INCA V7.2 SP13](#)

INCA V7.2 – What's New

Add-on INCA-SIP



INCA-SIP – Support of Data Dictionaries

MATLAB®/Simulink® allows storing model data in workspace variables.

Similar to that, data dictionaries are persistent repositories of model relevant data, but they provide more capabilities than typical workspace variables (e.g. they can be stored in external files).

With this functionality, INCA-SIP users can access data that is stored in data dictionaries within INCA.

[Available with INCA V7.2 SP13](#)

INCA V7.2 – What's New

Add-on INCA-SIP



INCA-SIP – Display measurement values of referenced models

In the past, INCA/INCA-SIP could only display calibration parameters when using referenced models in Simulink®.

With this functionality, the user has the ability to define which additional measurement values he wants to be displayed in INCA.

[Available with INCA V7.2 SP13](#)

INCA V7.2 – What's New

Add-on INCA-SIP



INCA-SIP – Basic support of Stateflow® blocks

Stateflow® provides a model and decision logic using state machines and flow charts and is often used together with Simulink®.

Users of INCA-SIP would like to see and calibrate the variables of Stateflow® blocks in INCA, similar to how they see other model parameters.

This new functionality supports the basic functionality of Stateflow® blocks used in Simulink® models.

[Available with INCA V7.2 SP13](#)

INCA V7.2 – What's New

Add-on INCA-EIP



EIP – Support of ES830 as E-Target Interface

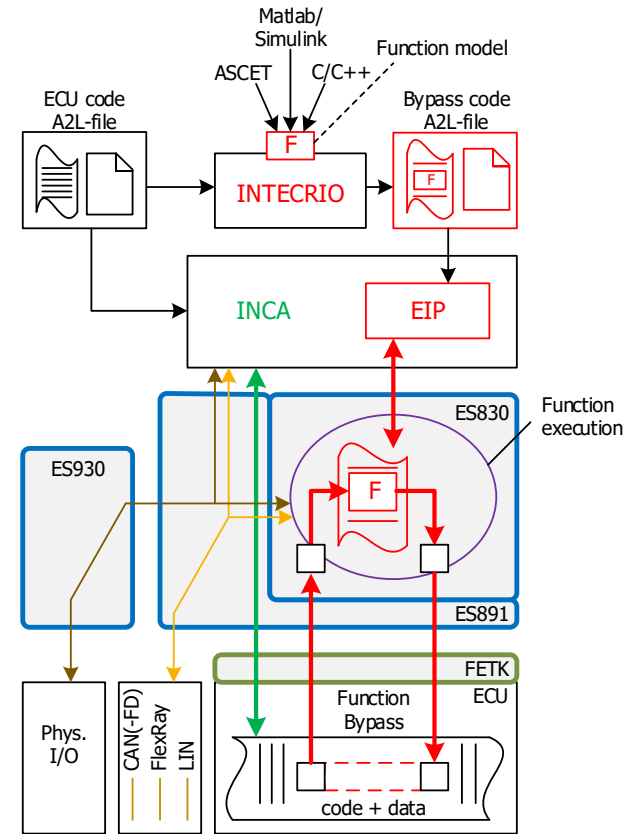
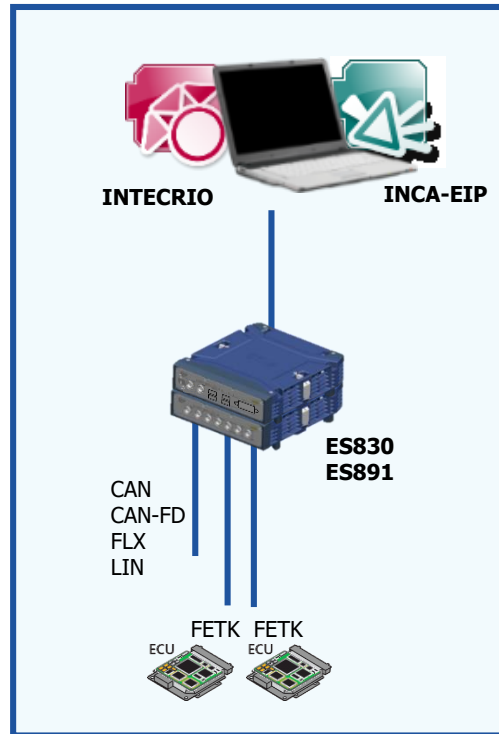

Available with INCA V7.2 SP7

INCA V7.2 – What's New

Add-on INCA-EIP



EIP – Support of Arrays up to 64k (8Bytes)

INCA can now handle ETARGET* arrays up to 65536 elements
This is valid for MEASUREMENT** and PARAMETER arrays

INCA can furthermore check for the max size of an array
and determine whether it fits to the new limits or not.

In the Experiment the combined editor can be
used to display the PARAMETER arrays.

*Virtual Prototypes do not support the large arrays

**MEASUREMENT arrays are treated by INCA as multiple scalars

Name	Bytes	Data Source	Element Type
GEM_facAir_mFct_C_VW.Test_Stumpp	0x3E804	ES910/Simulation Controller:1	64-bit Float
GEM_facAir_mMdl_VW	0x8	ES910/Simulation Controller:1	64-bit Float
dT	0x8	ES910/Simulation Controller:1	64-bit Float
GECDcpl_idxRampAsg_mFuCmb_VW	0x4	ES910/Simulation Controller:1	32-bit Unsigned
CEPfil_stStc_tDeRgnNrm_VW	0x4	ES910/Simulation Controller:1	32-bit Unsigned
ArryIndex_VW.Test_Stumpp	0x4	ES910/Simulation Controller:1	32-bit Unsigned



INCA V7.2.11
Experiment: >NewExp < Hardware: >Workspace <
ES910/Simulation Controller:1 | WP: Test_32000_DS1_1 | RP: Test_32000_DS1 | Diff.: 64

GEM_facAir_mFct_C_VW.Test_Stumpp <Vz	[]
x	84 31985 31986 31987 31988 31989 31990 31991 31992 31993 31994 31995 31996 31997 31998 31999
z	00 0.00 0.00 0.00 0.00 0.00 0.00 0.00 0.42 0.42 0.42 0.42 0.42 0.42 0.42 0.42

Available with INCA V7.2 SP11

INCA V7.2 – What's New

Add-on INCA-EIP



EIP – Allow up to 15000 Measurements per Raster in the ETARGET

In the past the maximum amount of measurement labels per raster was limited, e.g. to 2000 signals for the ES910.

INCA-EIP increases now the amount of measurement labels per raster for the ETARGETs*

- Support 15000 signals or 2MBytes for ES910.3
- Support 15000 signals or 8MBytes for ES830
- Support 15000 signals or 32kBytes for RT-PRO PC

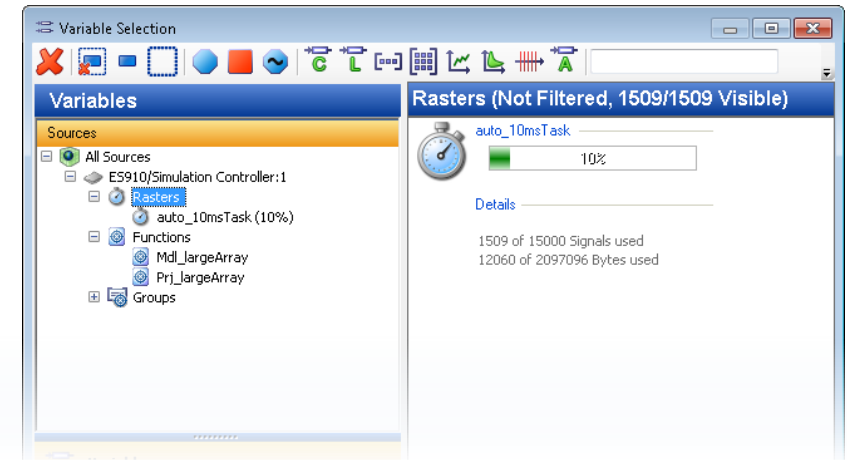

* Limitations: Virtual Prototypes do not support the increased measurement labels per raster; the available L1 buffer depends on the used ETARGET Hardware, however the INCA VSD determines in an online raster check the actual size.

[Available with INCA V7.2 SP11](#)

INCA V7.2 – What's New

Functionality



EIP – Support of Default Raster

INCA suggests to select the measurement in the default raster

- Measuring is done in the correct raster
- It makes the variable selection faster and easier

```
/begin MEASUREMENT
/* Name */ BypassOffset.BypassOffset_U.BypModel_IN1
/* Long identifier */ ""
/* Data type */ FLOAT64_IEEE
/* Conversion method */ BypassOffset_CM_double
/* Resolution */ 0
/* Accuracy */ 0
/* Lower limit */ -1.7e+308
/* Upper limit */ 1.7e+308
ECU_ADDRESS 0x0
DISPLAY_IDENTIFIER BypassOffset.BypModel_IN1
/begin IF_DATA E_TARGET
  KP_BLOB 0xFFFFFFFF 0xFFFFFFFF 3 1001 0 1001 1 1001 0
/end IF_DATA
/end MEASUREMENT
```

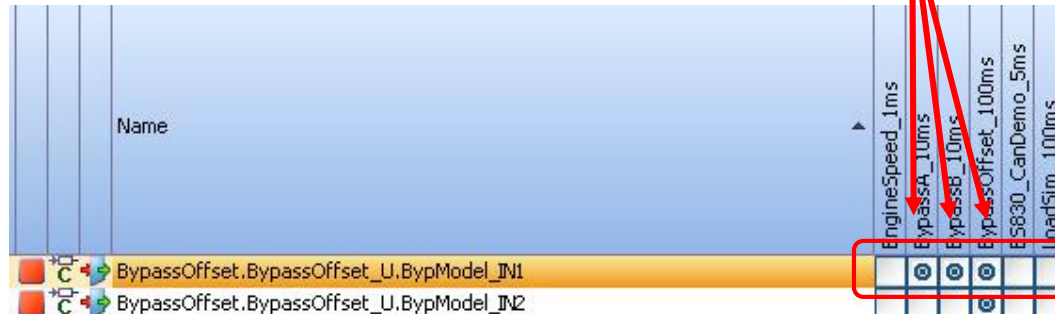

```
/begin IF_DATA E_TARGET
/begin SOURCE
/* Raster identifier */ "EngineSpeed_1ms"
/* Raster time unit */ 0 /* ms */
/* Raster period */ 1000
/* Raster number */ QP_BLOB 5
/end SOURCE
/begin SOURCE
/* Raster identifier */ "BypassA_10ms"
/* Raster time unit */ 0 /* ms */
/* Raster period */ 10000
/* Raster number */ QP_BLOB 1
/end SOURCE
/begin SOURCE
/* Raster identifier */ "BypassB_10ms"
/* Raster time unit */ 0 /* ms */
/* Raster period */ 10000
/* Raster number */ QP_BLOB 2
/end SOURCE
/begin SOURCE
/* Raster identifier */ "BypassOffset_100ms"
/* Raster time unit */ 0 /* ms */
/* Raster period */ 100000
/* Raster number */ QP_BLOB 3
/end SOURCE
/begin SOURCE
/* Raster identifier */ "ES830_CanDemo_5ms"
/* Raster time unit */ 0 /* ms */
/* Raster period */ 5000
/* Raster number */ QP_BLOB 4
/end SOURCE
/begin SOURCE
/* Raster identifier */ "LoadSim_100ms"
/* Raster time unit */ 0 /* ms */
/* Raster period */ 100000
/* Raster number */ QP_BLOB 6
/end SOURCE
```

Available with INCA V7.2 SP15

INCA V7.2 – What's New

Add-on INCA-MCE



MCE – Support of XCPonCAN FD via ES922

The extension card ES922 allows to use CAN FD together with the ES910

- o MCE supports to send XCPonCAN FD signals via iLinkRT or EtherCAT

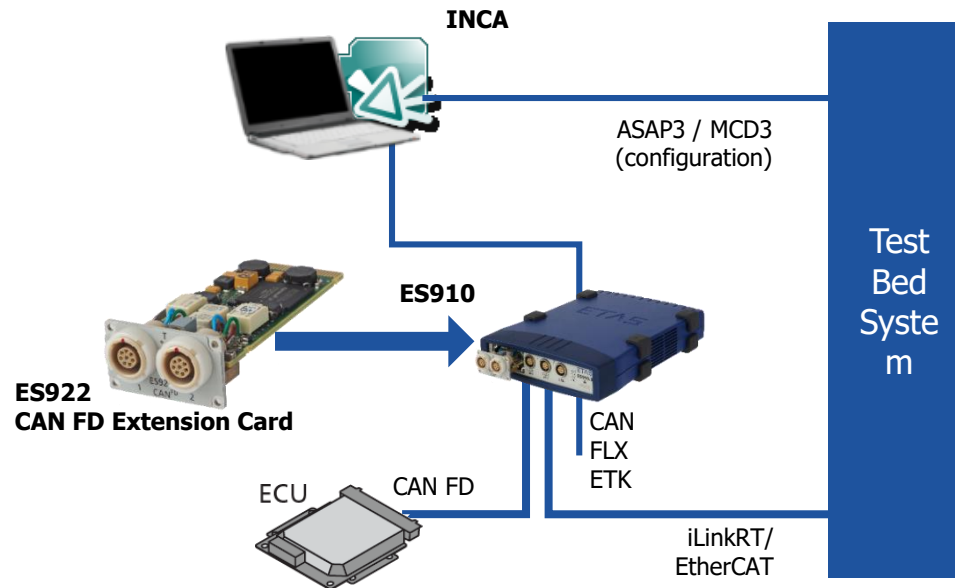

[Available with INCA V7.2 SP7](#)

INCA V7.2 – What's New

Add-on INCA-ODX



ODX – OBD and WWH-OBD update according to SAE J1979 of 2017-2

ODX-LINK now supports the SAE J1979-DA standard of Febr. 2017:

- New Mode 1 and Mode 2 **PIDs \$9D - \$A9**
- New Mode 6 **MIDs \$11 - \$14 and \$51 - \$54** and new unit and scaling ID support
- New Mode 9 **InfoTypes \$12 - \$29**
- New Mode 9 **IUMPR monitor counters**
- All new data is supported by the OBD UI window and new signals are available in the VSD for ODX polling measurement

The new ODX projects get installed with the SP9 ODX Add-on into the `<ETASData|ODX7.2|Projects>` folder:

- **OBDOnCAN_ETAS_SAEJ1979_2017-02.pdx**
- **WWH_OBD_ETAS_SAEJ1979_2017-02.pdx**

To use the new functionality, the new ODX projects have to be imported into INCA and assigned to a Workspace with OBDOnCAN device.

[Available with INCA V7.2 SP9](#)

INCA V7.2 – What's New

Add-on INCA-ODX



Add-on INCA-VOICE_RECORDER – Recording of spoken comments

The INCA Add-on Voice Recorder gives the possibility to record voice comments to a measurement.

The voice comments are stored in wav-Files. The link to the MDF file is given by events which are added to the MDF file.

The Add-on is available with the INCA service pack installer.

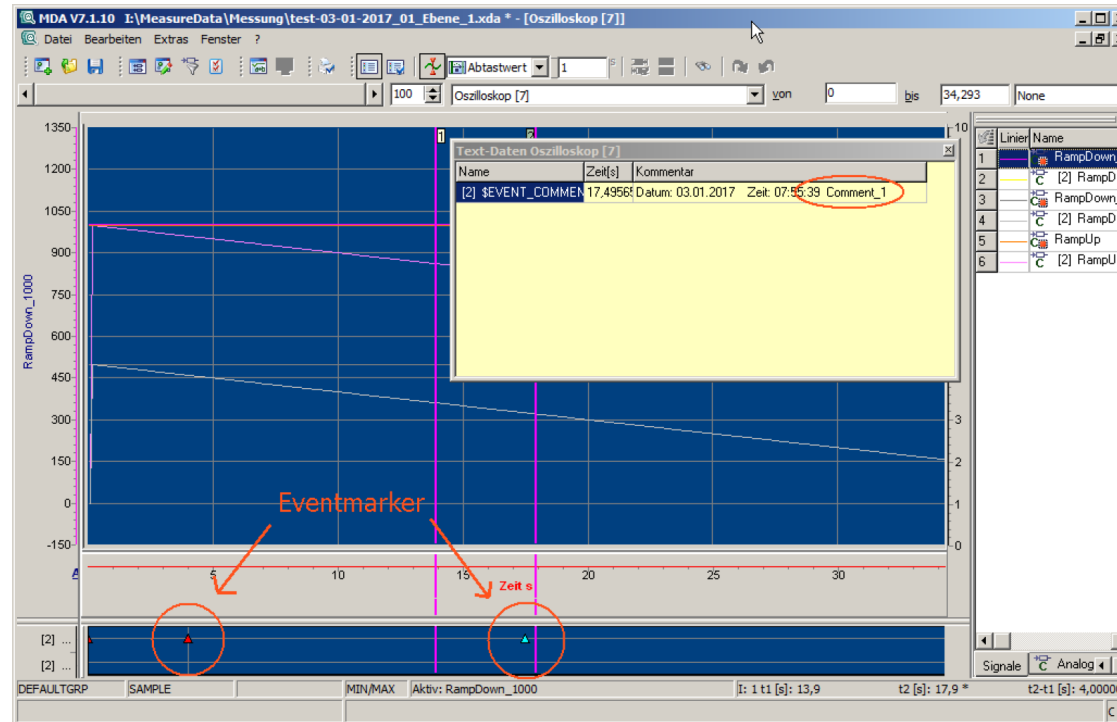

Note: A license is needed to use the add-on

Available with INCA V7.2 SP10

INCA V7.2 – What's New Functionality



ETAS Analytics Tool Box – Connect to INCA

Evaluation of the last recorded data

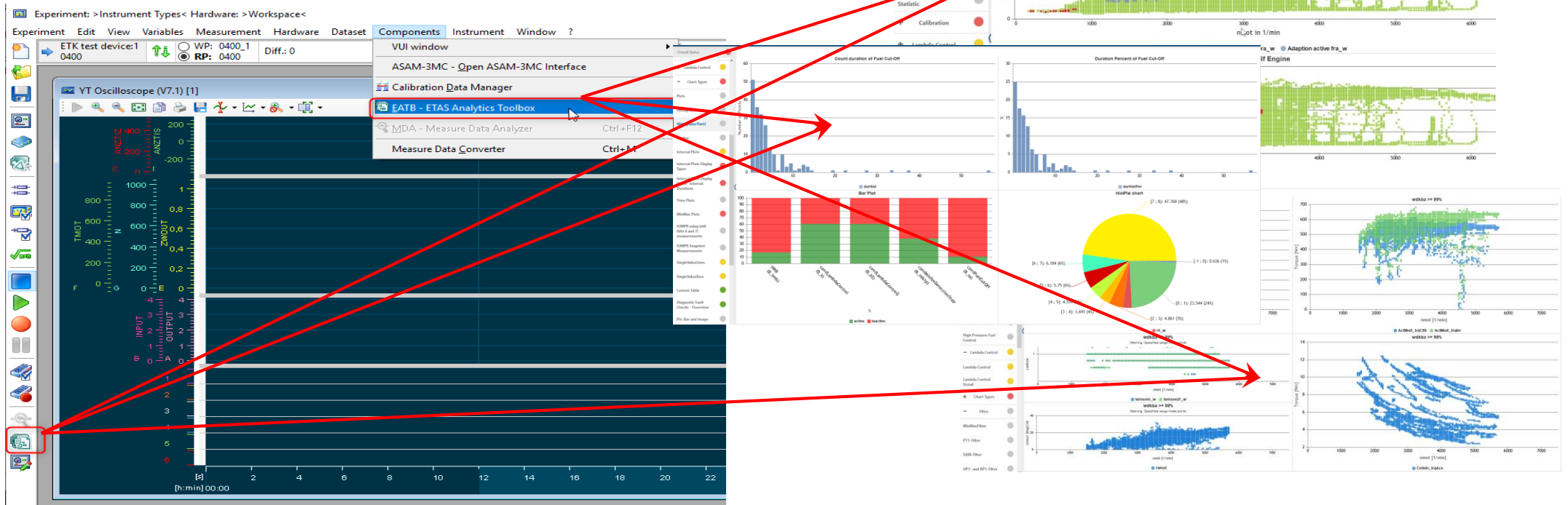

Note: This feature requires EATB V4.1 or higher

Available with INCA V7.2 SP15

INCA V7.2 – What's New

Slewing



Slewing - Multiple Slew Ranges

For ECU that use multiple controllers or controllers with multiple cores

The screenshot shows the 'Variable Selection' dialog in INCA. The 'Variables' pane on the left shows a tree structure with 'Slews_Core1' selected. The 'IsAASR_b_AAS1_CommFA_1 (Not Filtered,)' pane on the right shows a list of variables with their addresses. A red box highlights the selected variable 'IsAASR_b_AAS1_CommFA_1' in the tree and its corresponding entry in the list. A large blue arrow points downwards from the dialog to the 'Measure Window'.

Name	Address
IsAASR_b_AAS1_CommFA.x_SlewState	0x17FC3C
IsAASR_b_AAS1_CommFA.q_SlewAbsolute	0x17FC40
IsAASR_b_AAS1_CommFA.o_SlewModify	0x17FC44
VeAAS0_b_AAS1_CommFA	0x400145E8

```
/begin GROUP
Slews_Core1
" "
ROOT
/begin SUB_GROUP
IsAASR_b_AAS1_CommFA_1
IsAASR_b_AAS1_UcodeOrCommFA_1
IsAASR_b_AAS2_CommFA_1
IsAASR_b_AAS2_UcodeOrCommFA_1
IsAASR_Cnt_TorqueModeShtr1_1
IsAASR_Cnt_TorqueModeShtr2_1
IsAASR_Pct_CmdShtr1_1
IsAASR_Pct_CmdShtr2_1
IsAASR_U_IgnPT_Relay_1
/end SUB_GROUP
/end GROUP

/begin GROUP
IsAASR_b_AAS1_CommFA_1

/begin REF_CHARACTERISTIC
IsAASR_b_AAS1_CommFA.x_SlewState
IsAASR_b_AAS1_CommFA.q_SlewAbsolute
IsAASR_b_AAS1_CommFA.o_SlewModify
/end REF_CHARACTERISTIC
/begin REF_MEASUREMENT
VeAAS0_b_AAS1_CommFA
/end REF_MEASUREMENT
/end GROUP
```

```
/begin CALIBRATION_METHOD
"Slewing"
3
/begin CALIBRATION_HANDLE
0x0017FC00
0x00000200
0
CALIBRATION_HANDLE_TEXT "Slews_Core1"
/end CALIBRATION_HANDLE
/begin CALIBRATION_HANDLE
0x0017FE00
0x000001F8
0
CALIBRATION_HANDLE_TEXT "Slews_Core2"
/end CALIBRATION_HANDLE
/end CALIBRATION_METHOD
```

The screenshot shows the 'Measure Window [1]' for the variable 'VeAAS0_b_AAS1_CommFA'. The 'Mode' is set to 'CeSlewOff'. The 'Absolute' value is 0.00000 and the 'Modify' value is 0.00000.

Mode	Absolute	Modify
CeSlewOff	0.00000	0.00000

Available with INCA V7.2 SP15

INCA V7.2 – What's New

Functionality



ETK Tools

- Support of TC36x and TC37x production device (XETK-S20, XETK-S30, BR_XETK-S1 BR_XETK-S3, FETK-S1.1B)

Microcontroller Type	TC39xED (B Step)
DAP Clock Speed [MHz]	TC38x_A
DAP Mode	TC39xED (A Step)
ECU Standby RAM Power Supply Supervision	TC39xED (B Step)
Handshake Timeout [ms]	TC37xED_A
Trigger Register Polling Rate [µs]	TC37x_A
	TC36x_A

- Support of STMicro Centauri (Flashing)

Program CENTAURI SR6P7x-A - CODE FLASH [cluster0]
Program CENTAURI SR6P7x-A - CODE FLASH [cluster0]
Program CENTAURI SR6P7x-A - DATA FLASH [eeprom]
Program CENTAURI SR6P7x-A - CODE + DATA FLASH [cluster0 + eeprom]
DbgTest CENTAURI SR6P7x-A - Bootstrap startup only [no flashing]

- Support of ECU-Info Mailbox, currently only with BR-XETK-S4 (Centauri)
 - The ECU can provide information, originally defined in the A2L file, via a mailbox. This information overwrites the definition, given in the A2L file.

Available with INCA V7.2 SP15

INCA V7.2 – What's New

Overview

1. Product information (Use cases, Sample applications, Customer value) 3. Phase out information

- Performance
- Functionality
- Standards
- Usability
- HW support
- Add-ons

2. INCA Product Family

4. General Notes



INCA V7.2 – What's New

INCA Product Family



ETAS License Server – Contingent Mode

ETAS supports now an Contingent Mode to allow the user to work for some days without license in a Grace Mode.

INCA allows the user a contingent of 14 days to work without license, beginning from the first installation of INCA. The contingent of 14 days can be split to single days e.g. when the network is not available.

The Contingent Mode supports additionally a refill mechanism that brings back used Grace Mode days after a longer period working with a valid license.

The new Contingent Mode replaces the former Grace Mode handling and affects all ETAS Tools that use the ETAS License Manager with Grace Mode.

	G	G	G	G	G	G
G	G	G	G	G	G	G
G	x	x	x	x	x	x
x	x	x	x	x	x	x
x	x	x	x	x	x	x

Former Grace Mode

	G		G	G		
G	G	G		G		
			G			
	G			G		
	G	G	G	G	x	x

New Contingent Mode

[Available with INCA V7.2 SP13](#)

INCA V7.2 – What's New

INCA Product Family



Contingent Mode – Recommendations

To ensure that contingent does not run out on the user's PC, we recommend

- Ensure you have a sufficient number of floating licenses for parallel usage
 - Do not forget to borrow licenses before disconnecting from the network
 - Optional: Activate "Auto Borrow" mechanism when installing INCA
 - Monitor remaining contingent of Grace Mode days. Shown when INCA is started in Grace Mode
 - If the contingent of Grace Mode days runs low unexpectedly, please contact the ETAS support
- The support can reactivate contingent in emergency cases

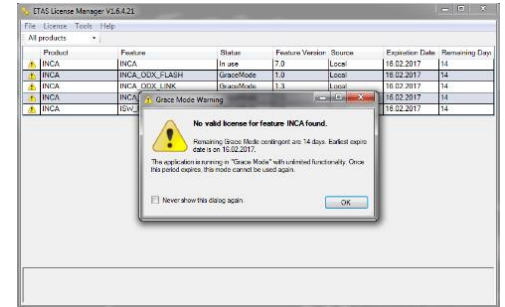

INCA / LIMA shows remaining contingent



LiMaTool.exe

Contingent Reset procedure

1. Customer sends "seed" file



2. Support sends "key" file



LiMaTool.exe

Available with [INCA V7.2 SP13](#)

INCA V7.2 – What's New

INCA Product Family



Service Pack Installer allows Downgrade

Beginning with SP3 the Installer compares automatically the version installed with the version to be installed.

Dependent to the result it offers upgrade or downgrade.

Necessary for downgrade is the availability of the complete service pack of the former version.

It is possible to up- and down-grade Base Installations, Service Packs and Hotfixes.

Service Pack Installation V2.2.3.71

This is a Service Pack Installer.
Please keep your ETAS-Products up to date.

Package	Installed Version	Package Version	Should Install	Status
ETAS INCA				
INCA	V7.2.3 Beta 88	V7.2.3 Beta 86	<input checked="" type="checkbox"/>	↓
General AddOns (free)				
AddOn_Daisy-Chain-ES4xx	V7.2.3 Beta 77	V7.2.3 Beta 75	<input checked="" type="checkbox"/>	↓
AddOn_Daisy-Chain-ES6xx	V7.2.3 Beta 80	V7.2.3 Beta 78	<input checked="" type="checkbox"/>	↓
AddOn_Daisy-Chain-ES93x	V7.2.3 Beta 74	V7.2.3 Beta 72	<input checked="" type="checkbox"/>	↓
AddOn_ES5xx	V7.2.3 Beta 71	V7.2.3 Beta 69	<input checked="" type="checkbox"/>	↓
AddOn_ES9xx	V7.2.3 Beta 71	V7.2.3 Beta 69	<input checked="" type="checkbox"/>	↓
AddOn_3rdPartyHardware	V7.2.3 Beta 71	V7.2.3 Beta 69	<input checked="" type="checkbox"/>	↓
AddOn_eCDM	V7.2.3 Beta 71	V7.2.3 Beta 69	<input checked="" type="checkbox"/>	↓
AddOn_DriveRecorder	⊖	V7.2.3 Beta 74	<input type="checkbox"/>	
AddOn_KID	⊖	V7.2.3 Beta 69	<input type="checkbox"/>	
AddOn_Video-Tutorials	⊖	V7.2.3 Beta 69	<input type="checkbox"/>	
Licensed AddOns				
AddOn_MCE	V7.2.3 Beta 71	V7.2.3 Beta 69	<input checked="" type="checkbox"/>	↓
AddOn_FlexRay	V7.2.3 Beta 71	V7.2.3 Beta 69	<input checked="" type="checkbox"/>	↓
AddOn_LIN	V7.2.3 Beta 71	V7.2.3 Beta 69	<input checked="" type="checkbox"/>	↓
AddOn_QM-Basic	V7.2.3 Beta 71	V7.2.3 Beta 69	<input checked="" type="checkbox"/>	↓
AddOn_INCA-EIP	V7.2.3 Beta 71	V7.2.3 Beta 69	<input checked="" type="checkbox"/>	↓
AddOn_INCA-SIP	⊖	V7.2.3 Beta 71	<input type="checkbox"/>	
AddOn_ODX	V7.2.3 Beta 75	V7.2.3 Beta 73	<input checked="" type="checkbox"/>	↓

Language (used for user interface of all ETAS multi-language software)
English

Install Close

Available with INCA V7.2 SP3

INCA V7.2 – What's New

INCA Product Family



Service Pack Installer – Show Errors in GUI

In Case of an installation error the Service Pack Installer provides now a link to more detailed information

Service Pack Installer V2.2.12.1

This is a Service Pack Installer.
Please keep your ETAS-Products up to date.



Package	Installed Version	Package Version	Install	Status	
ETAS INCA			<input checked="" type="checkbox"/>		
INCA		V7.2.11 Beta 100	<input checked="" type="checkbox"/>		Error code : 65574. See logs for more details
General AddOns (free)			<input type="checkbox"/>		
AddOn_Daisy-Chain-ES4xx		V7.2.11 Beta 74	<input type="checkbox"/>		
AddOn_Daisy-Chain-ES6xx		V7.2.11 Beta 73	<input type="checkbox"/>		
AddOn_Daisy-Chain-ES93x		V7.2.11 Beta 74	<input type="checkbox"/>		
AddOn_ES5xx		V7.2.11 Beta 71	<input type="checkbox"/>		

Available with INCA V7.2 SP11

INCA V7.2 – What's New

INCA Product Family



Support Shell – Display customer specific support info in "Support" shell

This allows to show some company specific information beside the ETAS support info

An CustomerSupport.rtf file can be deployed to C:\ProgramData\ETAS\{toolname}\SupportInfo\ and its content is displayed below the ETAS info

The rtf can contain plain text and also hyperlinks.

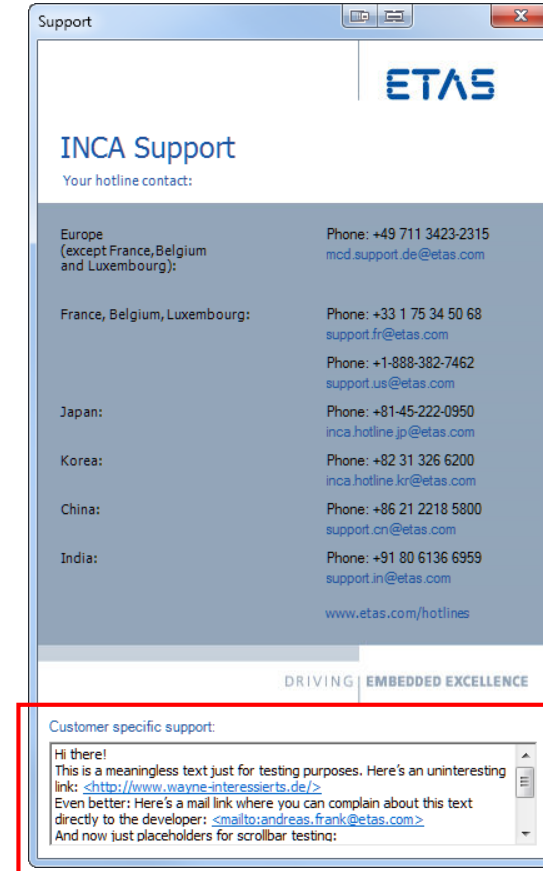

Available with INCA V7.2 SP11

INCA V7.2 – What's New

INCA Product Family – New License Key



New License Keys

- With INCA V7.2 new license keys will be introduced for
 - INCA
 - MDA
 - INCA add-ons
- New licenses files will be provided for all installations under maintenance
- New license keys are backward compatible
(will allow the usage of INCA V7.2 as well as earlier versions like INCA V7.1, V7.0 and V6)

INCA V7.2 – What's New

INCA Product Family – New License Key



Upgrade of ETAS License Server from V11.11.1 to V11.15.1

License Server has to be updated for usage with ETAS SW

- Machine based licenses are not effected
- License servers from other tool vendors are not affected by this upgrade

Compatibility after upgrade to V11.15.1:

Intention for the upgrade

- V11.11.1 is no longer maintained by Flexera
- Support of WinServer 2016

e.g. INCA \leq V7.2 SP11

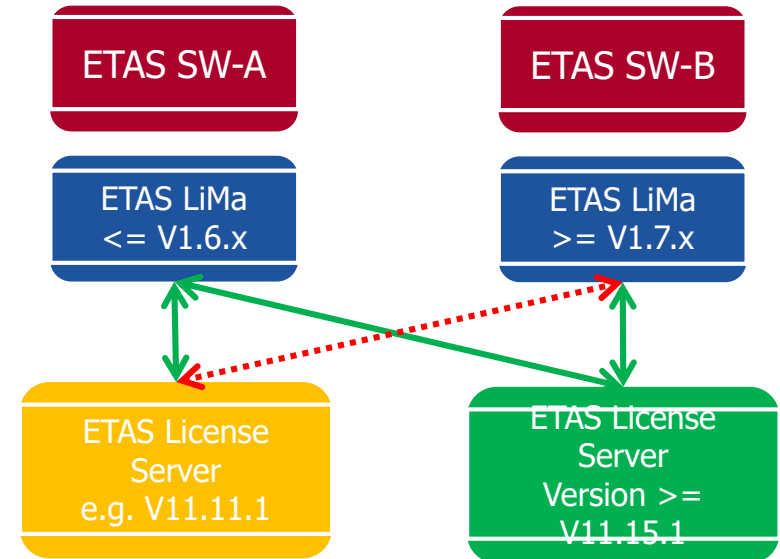

◀.....▶ Previous ETAS License server with version $<$ 11.15.1 is not compatible with newer ETAS-LiMa V1.7.x

INCA V7.2 – What's New

INCA Product Family – New License Key



Distribution of new license files

- Along with the product DVD, the customer will receive an entitlement certificate with the new license numbers for INCA V7.2
- V7.2 licenses, that were activated in the previous version (V7.0) will be automatically activated for the same host within the upgrade process. The customer can download the new keys by himself using the ETAS licensing portal <https://license.etas.com/flexnet/operationsportal/showSelfRegisterUserPage.do>

or

get them from his ETAS Sales contact.

INCA V7.2 – What's New

INCA Product Family – New License Key



Replacing License File – Dependent on the License Type

- **Local licenses** (machine based)
 - New license key has just to be installed as usual on the client machine.
 - Old license key can be removed
- **For server based environments**
 - With Autoborrow
 - New license keys have to be deployed in parallel within the current INCA 7.0 licenses (both versions of the license residing on the license server)
 - The new license keys (V7.2) have to be marked with the keyword **sort=(value > 100)** to avoid lost of current license usage information
 - After a transition phase the old licenses keys shall be removed from the server

INCA V7.2 – What's New

INCA Product Family – New License Key



Replacing License File – Dependent on the License Type

- **For server based environments**

- Without Autoborrow

- The license keys V7.0 can be just replaced by the new license keys V7.2 on the server
- In case the user tries to execute an early return of a borrowed old license (V7.0/V7.1), he has to confirm the following dialog with "Yes".

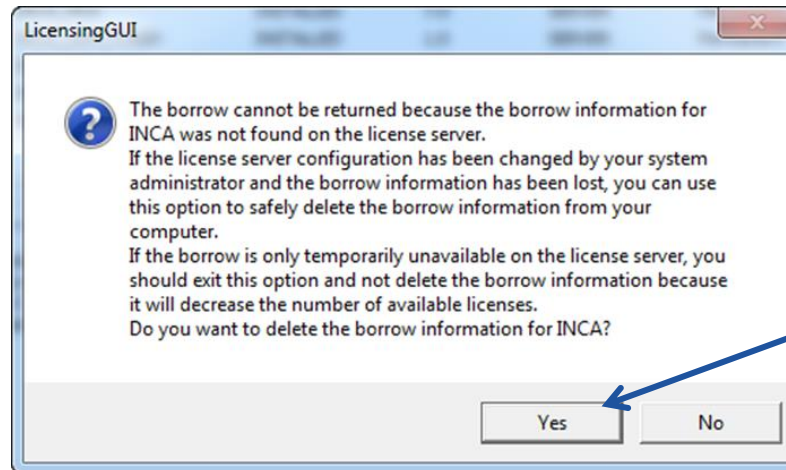

By clicking „Yes“, the local (borrowed) license will be removed and the user can borrow a license from the new license pool V7.2

INCA V7.2 – What's New

INCA Product Family – New License Key



Additional license types for INCA-FLEXRAY and INCA-LIN

- **INCA-FLEXRAY** and **INCA-LIN** have now three different licenses types
 - Machine based license
 - User based license
 - Floating license
- **Migration**
 - Customers with valid service contract for INCA-FLEXRAY / INCA-LIN will be migrated to a machine based license
 - Migration to user based or floating license on demand possible

INCA V7.2 – What's New

Merge INCA-SIP with INCA-EIP



With INCA V7.2 INCA-SIP will become part of INCA-EIP

- **INCA-EIP** will cover **INCA-SIP**
 - One single Add-on for virtual targets and rapid prototyping targets
 - User still can install INCA-EIP and INCA-SIP separately, according to his needs
- **Migration**
 - SIP users without a service contract keep their license but cannot use version 7.2 and higher
 - SIP users with a service contract will receive new EIP licenses key (free) and be migrated to an EIP Service Contract with the renewal of next service contract
 - EIP users without a service contract keep their license, but cannot use version 7.2 and higher
 - EIP users with a service contract receive new EIP licenses key (free) covering SIP as well
 - The price for EIP service contract will not change

INCA V7.2 – What's New

Replacement of INCA-VLINK by INTECRIO-RLINK



With INCA V7.2 the Add-on INCA-VLINK will be discontinued

- **INCA-VLINK** functionality will be covered by **INTERCRIO-RLINK**
- **Migration**
 - VLINK users without a service contract keep their license, but cannot use version 7.2 and higher
 - VLINK users with a service contract receive new RLINK license keys (free) and are migrated to a RLINK Service Contract with the renewal of next service contract

INCA V7.2 – What's New

New Product Cut for Prototyping



Changed Product Cut for Prototyping

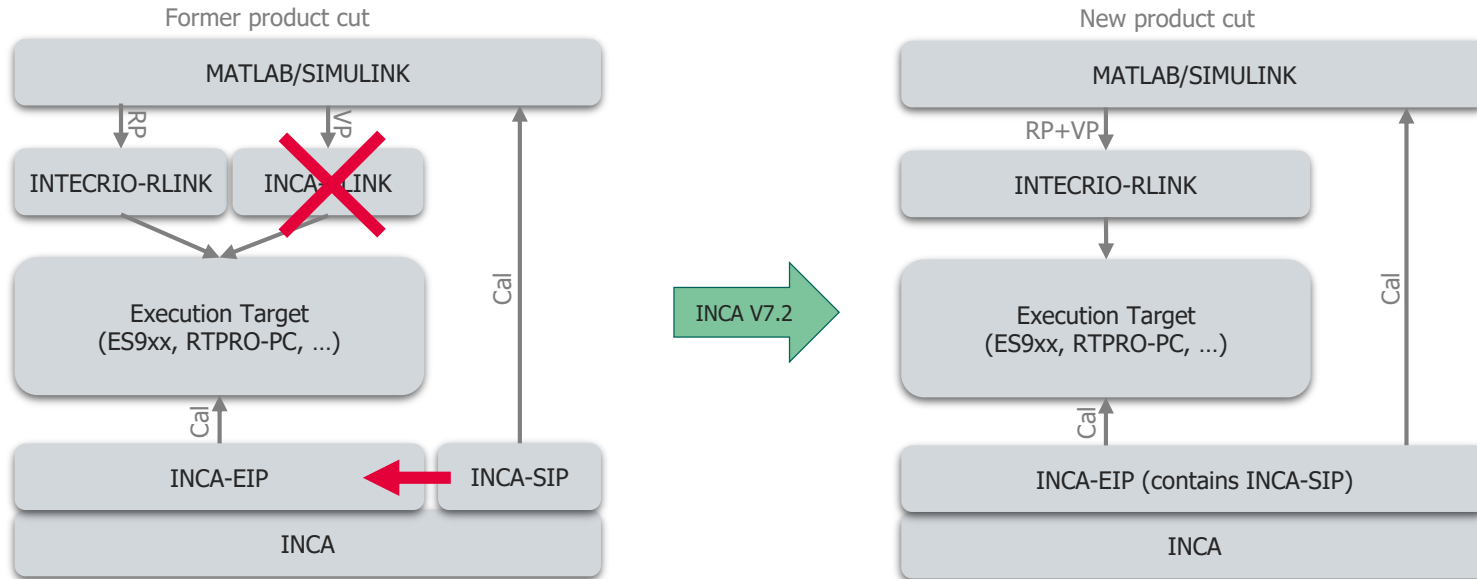

- [Discontinuation of VLINK](#)
- [Integration of INCA-SIP to INCA-EIP](#)

INCA V7.2 – What's New

Introduction of MSI Installer



Installation for INCA V7.2 will be based on MSI technology

- With INCA V7.2 the INCA installer will be based on MSI technology
- Relevant for customers deploying INCA via central installation mechanism
- Benefits
 - Same installer mechanism for ETAS products (e.g. LABCAR, INTECRIO,...)
 - Based on “standard” Microsoft technology for easier integration into customers IT infrastructure

INCA V7.2 – What's New

Overview

1. Product information (Use cases, Sample applications, Customer value)

- Performance
- Functionality
- Standards
- Usability
- HW support
- Add-ons

2. INCA Product Family

3. Phase out information

4. General Notes



INCA V7.2 – What's New

Phase Out Information



ES1000

ES1000.3 System

- Including:
- ES1000.3
 - ES1120.3
 - ES1135.1
 - ES1222.4-A
 - ES1232.2-A
 - ES1303.1
 - ES1310.1
 - ES1325.1
 - ES1380.2/KID2

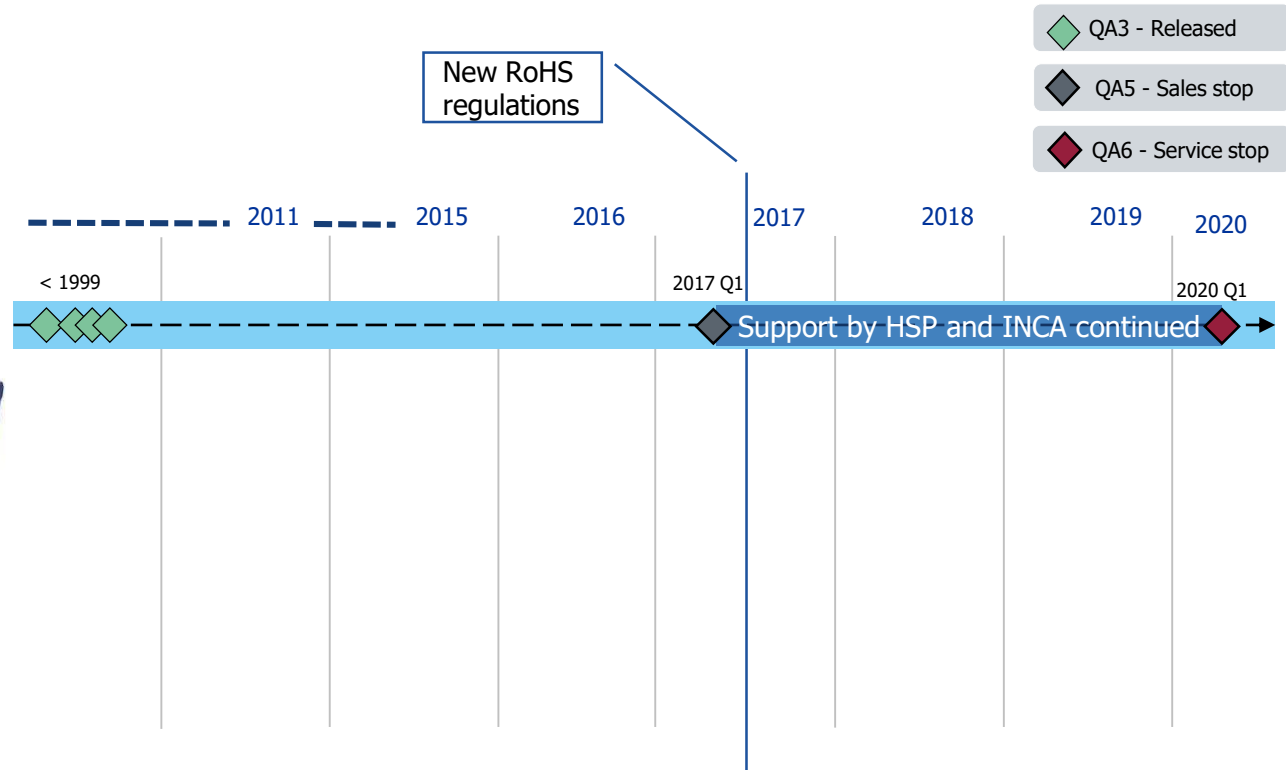

INCA V7.2 – What's New

Phase Out Information



ES590 / ES591

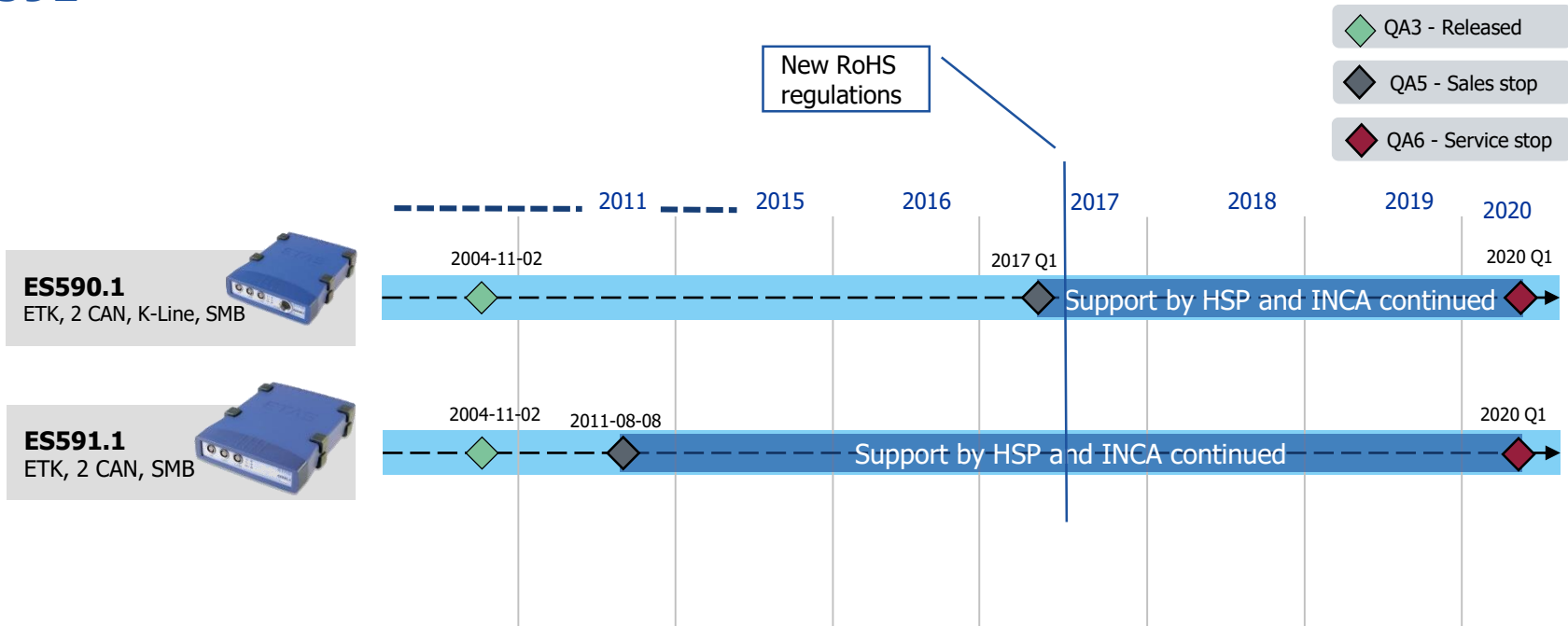

INCA V7.2 – What's New

Phase Out Information



Maintenance stop for INCA under Windows Vista

- Microsoft announced the end of the Extended Support for Windows Vista by 11th of April 2017
<http://windows.microsoft.com/en-us/windows/lifecycle>
- ETAS will stop the INCA maintenance for Windows Vista by 11th of April 2017 too

INCA V7.2 – What's New

Phase Out Information



Maintenance stop for INCA under Windows 7

- Microsoft announced the end of the Extended Support for Windows 7 by January 14, 2020
<http://windows.microsoft.com/en-us/windows/lifecycle>
- ETAS will stop the INCA maintenance for Windows 7 by January 14, 2020, too

INCA V7.2 – What's New

Phase Out Information



Maintenance Stop for INCA V7.1

INCA V7.x Maintenance

- ETAS continues INCA V7.1 by INCA V7.2
- With the release of INCA V7.2
 - New Features and Bugfixes are delivered with Service Packs for INCA V7.2
 - For INCA V7.1 there will be no more Updates

INCA V7.2

- Available for all users with Service Contract free of charge
- Now with MSI Installer
- Installable in parallel to INCA V7.1
- New license keys that support INCA V7.2 down to INCA V6

INCA V7.2 – What's New

Phase Out



Discontinuation of Support of Matlab V2014B / Simulink 2014B and earlier

Matlab / Simulink supports MS Windows 10 beginning with V2015A. As INCA is going to be used mainly with Windows 10 ETAS focuses on Matlab / Simulink V2015A or higher.

Beginning with INCA V7.2 SP12 ETAS will no longer test combinations of INCA and Matlab / Simulink on MS Windows 7.

It is strongly recommended to use Matlab / Simulink V2015A or higher in combination with INCA

INCA V7.2 – What's New

Phase Out



Discontinuation of ODX Flash

The last version of ODX Flash will be delivered with INCA V7.2 SP12.

The ODX Flash functionality will be discontinued with INCA V7.2 SP13. Beginning with INCA V7.2 SP13 the INCA ODX Add-on will no longer contain the ODX Flash functionality.



Reduction of ODX Link Functionality

Beginning with INCA V7.2 SP13 the INCA ODX Add-on will no longer contain the ODX Flash functionality.

Additionally beginning with INCA V7.2 SP13 some very specific diagnostic windows will be removed:

Memory Dump Window (Read ECU memory segments)

- Was only usable for KWP2000 (readMemoryByAddress)
- Similar functionality is available with the Diagnostic Services Window

DTC Window

Read and Clear of DTCs (fault memory) and related Freeze Frames (environment data at error time). Compact display of the DTCs as list / tree (related DTC Status Flags)

- Requires complex and extensive configuration by the user (selection and parametrization of the ODX services to read DTCs und environment data)
- Same functionality is available in the Diagnostic Services window (manual selection of the ODX services to read fault memory / error frames)

Sequence Window

Configuration and replay of diagnostic services. The ECU responses can be filtered to show only relevant parameters.

- Functionality is available in the Diagnostic Services window
 - Either by ODX Java Jobs, which can be called in the Diagnostic Services window
 - Or by manual calling of single services of a sequence (without response filtering)

INCA V7.2 – What's New

Hardware Phase Out Announcement



Reduction of HW Support in INCA

Beginning with INCA V7.2 SP13 the ES520 hardware module will not be supported by INCA anymore.

- ES520 has already QA6 (service stop) status and will not be supported by HSP anymore.

Beginning with INCA V7.2 SP13 the Kvaser hardware module will not be supported by INCA anymore.

- QA6 (service stop) workflow already started.

INCA V7.2 – What's New

Overview of Functionality added by Service Packs



Links to Functionality Description of Service Pack 1

- [VSD - Add function list to Experiment tree](#)
- [COM-API - Support of 32Bit and 64Bit Clients](#)
- [MCE - FETK Support](#)
- [MCE – Variable Selection](#)
- [XCP V1.3 - Slave detection on Ethernet](#)
- [XCP - ODT Optimization & Measurement Data Consistency](#)
- [Limited EMU RAM - Download for Data Freeze](#)

INCA V7.2 – What's New

Overview of Functionality added by Service Packs



Links to Functionality Description of Service Pack 2

- [Key Variable List](#)
- [Resolution of IP address conflict of ETAS HW](#)
- [Exchange recorder configuration](#)
- [Multi Raster – Measurements are updated even when some raster do not send data](#)
- [FlexRay data from Autosar Description File V4.1/V4.2](#)
- [VN7610 Support](#)

INCA V7.2 – What's New

Overview of Functionality added by Service Packs



Links to Functionality Description of Service Pack 3

- [Support New LAB format in VSD for Filters](#)
- [ASAP3 - Get & Set INCA Options / Get State](#)
- [Diagnostic on IP \(DoIP\) Flashing with PROF](#)
- [Key Variable List - Black List](#)
- [ASAP2 Container](#)
- [ES582.1 INCA Integration](#)
- [Service Pack Installer allows Downgrade](#)

INCA V7.2 – What's New

Overview of Functionality added by Service Packs



Links to Functionality Description of Service Pack 4

- [Reuse Parts of Experiment – Recorder](#)
- [IEEE 1588 Time Synchronization with ES891/ES892](#)
- [Improvement of the Time Synchronization in INCA](#)
- [Support of MATLAB 2016B / Support of Pre-lookup & Interpolation Blocks](#)

INCA V7.2 – What's New

Overview of Functionality added by Service Packs



Links to Functionality Description of Service Pack 5

- [Dynamic Emulation Mode – Calibration when Reference Page is different](#)
- [Database - Export only referenced data sets](#)
- [Support of MATLAB 2017A](#)
- [INCA-SIP supports referenced models](#)
- [INCA-TOUCH](#)

INCA V7.2 – What's New

Overview of Functionality added by Service Packs



Links to Functionality Description of Service Pack 6

- [Create Optimized exports for Drive Recorder](#)
- [Improvement of search for hardware functionality](#)
- [Disable search for J2534 hardware](#)
- [PROF – Full Support of DoIP Flashing](#)
- [CAN FD Monitoring – Container PDU](#)
- [CAN FD Monitoring - Secure Onboard Communication \(Secured I-PDU\)](#)
- [ASAP3 – Read Data Exchange File in EE](#)
- [INCA Options – GET / SET via COM API or ASAP3](#)
- [CDM - Variables in the output file name](#)
- [ES922 – INCA integration](#)
- [ES584.1 – INCA integration](#)
- [INCA-SIP - Support of mask parameters](#)

INCA V7.2 – What's New

Overview of Functionality added by Service Packs



Links to Functionality Description of Service Pack 7

- [Recorder – Variables for Output Path](#)
- [UDS on FlexRay flashing – Support sending functional requests](#)
- [AUTOSAR V4.3 - CAN FD & FlexRay](#)
- [ES882 – INCA integration](#)
- [EIP - Support of ES830 as E-Target Interface](#)
- [MCE - Support of XCPonCAN FD via ES922](#)
- [Support of MATLAB 2017B](#)

INCA V7.2 – What's New

Overview of Functionality added by Service Packs



Links to Functionality Description of Service Pack 8

- [Limited EMU RAM - Support of Renesas RH850 Overlay RAM](#)
- [64 Bit Integer Support \(limited to 32bit value range\)](#)
- [COM-API – Support of Bus Monitoring](#)
- [AUTOSAR – Support of Multiplexed-I-PDU monitoring for CAN/CAN FD](#)
- [AUTOSAR – End to End communication protection \(E2E\) for CAN/CAN FD Monitoring](#)
- [Alias Name – Show and edit it in the Hardware Configuration](#)
- [Data Base – Check for overlapping Parameters](#)
- [PROF XCP flashing – New XCP SET TIMEOUT command](#)
- [Allow search in "Add hardware device" dialog](#)

INCA V7.2 – What's New

Overview of Functionality added by Service Packs



Links to Functionality Description of Service Pack 9

- [Recorder – Variables for Measure File Name](#)
- [ASAP2 – Disable Download for OFFLINE DATA](#)
- [ASAP2 – Transfer Keyword SYMBOL LINK in MDF File](#)
- [COM-API – Support of CUBOID](#)
- [PROF – Flashing up to 255 Memory Segments](#)
- [AUTOSAR – Multiplexed-I-PDU for FlexRay Monitoring](#)
- [AUTOSAR – End to End communication protection \(E2E\) for FlexRay Monitoring](#)
- [AUTOSAR – Secured I-PDU for FlexRay Monitoring](#)
- [AUTOSAR – Container I-PDU for FlexRay Monitoring](#)
- [ES886 – INCA integration](#)
- [CAN FD Support for Vector VN Devices](#)
- [Support of MATLAB 2018A](#)
- [ODX – OBD and WWH-OBD update according to SAE J1979 of 2017-2](#)

INCA V7.2 – What's New

Overview of Functionality added by Service Packs



Links to Functionality Description of Service Pack 10

- [COM-API – Support of CUBE 4](#)
- [CAN-FD – Message Sending](#)
- [AUTOSAR – Update Bit support for CAN/CAN FD/FlexRay](#)
- [PROF – UDS messages up to 64kByte for CAN-FD and DoIP flashing](#)
- [ETK – Select the ETK interface when working offline](#)
- [Combined Editor - Arrays](#)
- [Polling Mode – Option for Configuration](#)
- [XCP - Support of new AML V1.4 / V1.5](#)
- [Add-on INCA-VOICE RECORDER – Recording of spoken comments](#)

INCA V7.2 – What's New

Overview of Functionality added by Service Packs



Links to Functionality Description of Service Pack 11

- [VSD – Filter for non-selected Variables](#)
- [VSD – Sorting by all columns](#)
- [COM-API – Check if ECU is turned on/off](#)
- [XETK – Display Raster Check Details for Distab 13](#)
- [FETK – Support of Alias Name](#)
- [USB Devices ES582/ES584 – Support of Alias Name](#)
- [INCA – "NaN" resp. "Inf" display in INCA](#)
- [EIP – Support of Arrays up to 64k \(8Bytes\)](#)
- [EIP – Allow up to 15000 Measurements per Raster in the ETARGET](#)
- [CDM – Inline Compare](#)
- [XCP V1.3 – Time Correlation / Time Synchronization](#)
- [MCE – Visualization of mapped XETK/FETK](#)
- [AUTOSAR – Container I-PDU for CAN/CAN FD and FlexRay Monitoring](#)
- [INCA-MIP & INCA-SIP – Support of MATLAB 2018B](#)
- [DBB - New HEX/S19 File Filter](#)
- [AUTOSAR – Support of Autosar V3.2.x for Flexray](#)
- [Support Shell – Display customer specific support info in "Support" shell](#)
- [Service Pack Installer – Show Errors in GUI](#)

INCA V7.2 – What's New



Overview of Functionality added by Service Packs

Links to Functionality Description of Service Pack 12

- [HWC – Up to 20 XCP on Ethernet slaves](#)
- [INCA – Enhancements for writing of XDA files](#)
- [FETK – Mapping by Serial Number and Alias Name](#)
- [Variable Selection Dialog – Visualization of predefined Raster](#)
- [CDM – Support COPY for Limited EMU RAM](#)
- [ProF – Support spaces in paths and none-8dot3 path format for ProF flashing](#)
- [Editors – Paste from MS Excel](#)
- [Editors – Bit Editor – Decimal numbering](#)
- [AUTOSAR – Support of V4.1 / V4.2 / V4.3.x for XCP on Flexray](#)
- [XCP V1.4 – PACKET ALIGNMENT x – Packet Alignment for Ethernet](#)
- [XCP V1.4 – ERR TIMECORR STATE CHANGE - Additional error code for start/stop DAQ](#)
- [XCP V1.4 – START STOP SYNC – Enhancement of Command](#)
- [ASAP3 V3.0 – Extended Commands for Measurement & Calibration](#)
- [INCA-SIP](#)

INCA V7.2 – What's New

Overview of Functionality added by Service Packs



Links to Functionality Description of Service Pack 13

- [Monitoring – COM based PDU on Automotive Ethernet](#)
- [Experiment – Prevent unintended WP/RP switching](#)
- [Experiment – Improved UI support for Multi ECU handling](#)
- [VSD – Easy Raster re-assignment for changed ECU software](#)
- [XCP V1.4 – Support of Packed DAQ Lists \(DAQ Packed Mode\)](#)
- [XCP – IPv6 support for INCA](#)
- [VN5610/A – Support for Automotive Ethernet & BR-XETK](#)
- [Reduction of outdated INCA files](#)
- [ASAP3 V3.0 – Extended Commands for Measurement & Calibration](#)
- [INCA-MIP & INCA-SIP – Support of MATLAB 2019A](#)
- [INCA-SIP – Use Workspace Variable in INCA Experiment](#)
- [INCA-SIP – Support of Data Dictionaries](#)
- [INCA-SIP – Display measurement values of referenced models](#)
- [INCA-SIP – Basic support of Stateflow® blocks](#)
- [ETAS License Server – Contingent Mode](#)
- [Contingent Mode – Recommendations](#)

INCA V7.2 – What's New

Overview of Functionality added by Service Packs



Links to Functionality Description of Service Pack 14

- [Autosar – File Reparsing](#)
- [XCP – AUTOSAR Single Pointer Method via XCP protocol](#)
- [CDM - Multi Column View](#)
- [64 Bit Integer Support \(full range\)](#)
- [XCP - Additional Setting for the Source UDP Port in INCA HWC](#)
- [INCA-SIP – Remote Operation](#)
- [INCA-SIP – Enable 'Connect to INCA' when Model is Running](#)
- [Recording – Open MDA V8 from INCA EE](#)

INCA V7.2 – What's New

Overview of Functionality added by Service Packs



Links to Functionality Description of Service Pack 15

- [AUTOSAR – Show full Path of Cluster to identify ARXML File in the Workspace](#)
- [UDS on FlexRay – ISO FlexRay TP](#)
- [Slewing – Multiple Slew Ranges](#)
- [CDM – Write data exchange file for Groups separately](#)
- [COM-API – Support of Test Settings](#)
- [ETAS Analytics Tool Box – Connect to INCA](#)
- [ES886 – Extensions](#)
- [EIP – Support of Default Raster](#)
- [ETK Tools](#)
- [INCA-SIP – User configurable Hooks for Variable naming and filtering](#)
- [MATLAB 2019B](#)

INCA V7.2 – What's New

Overview

1. Product information (Use cases, Sample applications, Customer value) 3. Phase out information

- Performance
- Functionality
- Standards
- Usability
- HW support
- Add-ons

2. INCA Product Family

4. General Notes

INCA V7.2 – What's New

General Data Protection Regulation



Compliance to General Data Protection Regulation

Please note that personal data is processed when using INCA. As the controller, the purchaser undertakes to ensure the legal conformity of these processing activities in accordance with Art. 4 No. 7 of the General Data Protection Regulation (GDPR). As the manufacturer, ETAS GmbH is not liable for any mishandling of this data.

Data categories

Please note that INCA particularly records the following personal data (categories), and/or data (categories) that can be traced back to a specific individual, for the purposes of assisting with troubleshooting

- Communication data: IP address, date and time
- User data: The user's Windows UserID

Further information to this topic is available in the INCA installation handbook and the INCA online help.



Seminars offered at ETAS locations worldwide or at customer site

Deep skills and sound knowledge are essential prerequisites for handling software tools of ever-rising complexity. Our trainers are highly experienced engineers in the field of engineering and support, who relish sharing knowledge on ETAS products and development processes. Target groups for the trainings are beginners, advanced users and those who wish to expand their existing knowledge.

INCA – Calibration (3 days)

- Practical operation of the software and the knowledge of the INCA fundamentals
- Get to know the advantages and disadvantages of various calibration concepts

INCA - Advanced Calibration Techniques (2 days)

- Advanced functionalities in INCA, Tips & Tricks. INCA experience is required
- Workshop part, bring in your own problem statement

INCA - FLOW Coaching

- Using your own calibration tasks to see the benefits of INCA-Flow in your daily work

Some ETAS local offices have their own training programs which are specialized for the local needs. Please contact our local office of your area for the details: <https://www.etas.com/en/trainings.php>

INCA V7.2 – What's New

Virtual Machines



Usage of virtual PC machines

The usage of INCA on a virtual machine (VM) is restricted and not recommended:

- The VM needs sufficient working memory (RAM), otherwise the performance of INCA goes down
- Access to sufficient graphic card memory (Direct X) is necessary, otherwise the oscilloscope representation of measurement signal is not possible
- Access to hardware interfaces Ethernet, USB, PCMCIA, ... is necessary, otherwise INCA cannot use the connected hardware
- Measure samples may be lost and the accuracy of time stamps is not guaranteed as the higher task priority for hardware access (Target Server) is not given
- ETAS does no special tests concerning VM machines

ETAS recommends to use real PC hardware.

INCA V7.2 – What's New



System Requirements

Minimum System Requirements

- 2 GHz Processor, 2 GB RAM, and DVD-ROM drive *)
- Graphics: at least 1024x768, 256MB RAM, 16bit color and DirectX 9

Recommended System Requirements

- 3 GHz Quad-Core Processor, 16 GB RAM, and DVD-ROM drive *)
- Graphics: at least 1280x1024, 1GB RAM, 32bit color and DirectX 9
- Windows 7 SP1 64Bit
- Investigation on performance showed
 - More Memory improves execution time of repetitive operations
 - SSD Hard disks improve the file access times

Supported OS

- Windows 7 SP1 or higher
- Windows 8 or 8.1
- Windows 10

*) Needed for installation via DVD only
Not necessary when installing via network

INCA V7.2 – What's New

General Notes



Additionally Installed Components	INCA V7.0	INCA V7.1	INCA V7.2
Windows Installer 3.1 (MSI-Installer 3.1)	X ¹⁾	-	-
.Net-Runtime-Environment	V3.5 ¹⁾	V4.5.2 ¹⁾	V4.6 ¹⁾
VCxRedist (Vcredist_x86 / Vcredist_x64)	VC8+VC9	VC8+VC9+VC10+VC14	VC9+VC10 +VC14
JAVA SDK Version j2sdk1.4.2_11	X ²⁾	X ²⁾	X ²⁾
Perl V5.8.6	X	X	X
MSXML5.msi (XML 6.0 Parser)	X ¹⁾	-	-
Parallel-Interface driver ParComm.sys	X ³⁾	-	-
ETAS Certificate	-	X	X
Direct X	-	V9 (or higher)	V9 (or higher)
Others			
ETASShared	10	11	12
System-Requirements			
Windows XP (32bit)	X	- ⁷⁾	-
Windows Vista (32 bit)	X	X	- ⁸⁾
Windows 7 (32 / 64 bit ⁴⁾)	X	X	X
Windows 8 (32 / 64 bit ⁴⁾)	-	X ⁵⁾	X ⁶⁾
Windows 10	-	-	X ⁶⁾
<p>1) This component is installed only when no or an older version is installed. If a newer version is already installed, it will not be touched. This is checked by a Microsoft installation routine.</p> <p>2) This component is installed only with ODX LINK and ODX FLASH</p> <p>3) Not installed for Windows 7 or higher</p> <p>4) INCA uses the 32bit Compatibility Mode on a 64-bit operating system</p> <p>5) INCA V7.1-SP2 needed for Windows 8, INCA V7.1-SP8 needed for Windows 8.1</p> <p>6) For hardware driver support see release notes</p> <p>7) INCA V7.1-SP10 does no longer support Windows XP</p> <p>8) INCA V7.2-SP5 does no longer support Windows Vista</p>			



Thank you