



Ethernet Connection ES4xx/ES63x

Order Name	Length	Short Name	Order Number
------------	--------	------------	--------------

Ethernet PC Connection and Power Supply Cable (ES4xx/ES63x)

Connects an ES4xx/ES63x module to PC and power supply (standalone operation). Supply battery close to modules. Rugged water- and dust-proof (IP67).

Ethernet PC Connection and Power Supply Cable, Lemo 1B FGL - RJ45 - Banana (8fc-8mc+2mc), 3 m	3.00 m 9.84 ft	CBEP410.1-3	F-00K-104-927
---	-------------------	-------------	---------------

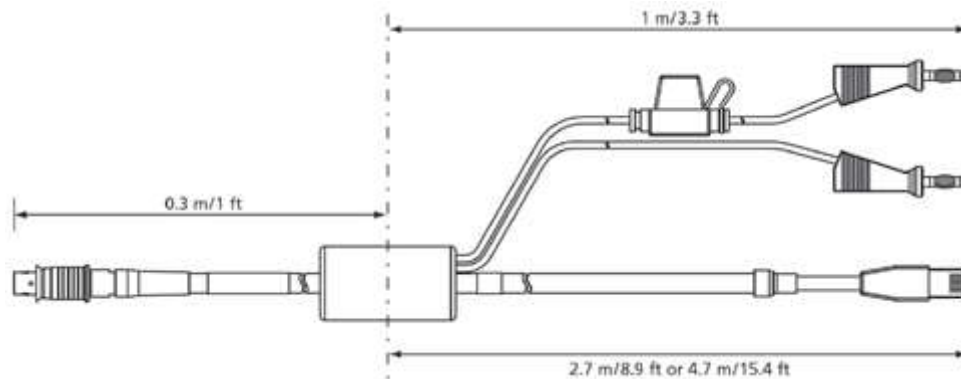

Ethernet PC Connection and Power Supply Cable, Lemo 1B FGL - RJ45 - Safety Banana (8fc-8mc+2mc), 3 m	3.00 m 9.84 ft	CBEP4105.1-3	F-00K-110-026
--	-------------------	--------------	---------------

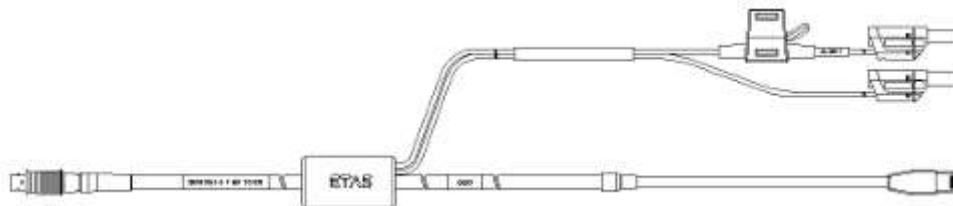

Connects an ES4xx/ES63x module to PC and power supply (standalone operation). Supply battery at far end (i.e. in trunk). Rugged water- and dust-proof (IP67).

Ethernet PC Connection and Power

Supply Cable, Power Feeder close to PC, 5.00 m
 Lemo 1B FGL - RJ45 - Banana (8fc- 16.40 ft CBEP415.1-5 F-00K-105-680
 8mc+2mc), 5 m

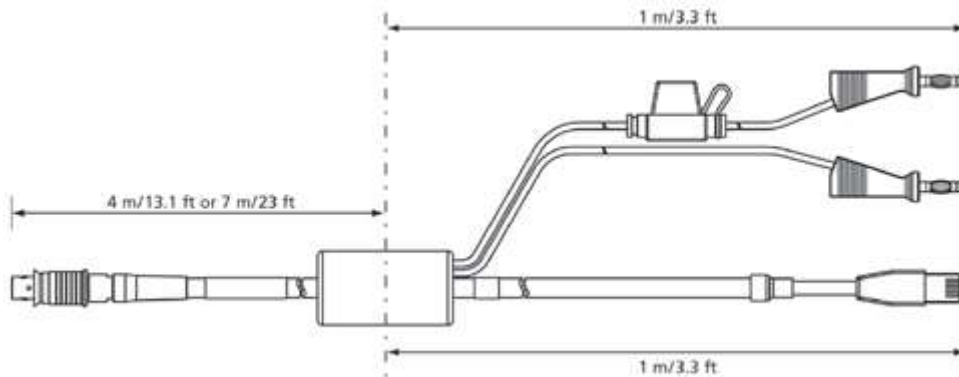

Ethernet PC Connection and Power

Supply Cable, Power Feeder close to PC, 5.00 m
 Lemo 1B FGL - RJ45 - Safety Banana (8fc- 16.40 ft CBEP4155.1-5 F-00K-110-027
 8mc+2mc), 5 m

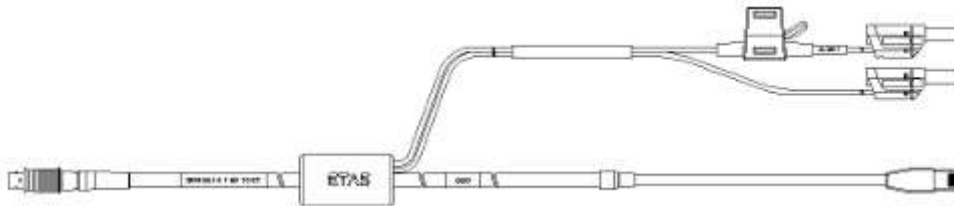
**Ethernet ES71x Connection Cable (ES4xx/ES63x)**

Connects an ES4xx/ES63x module to ES715 Drive Recorder and power supply (standalone operation). Rugged water- and dust-proof (IP67).

Ethernet ES71x Connection and Power

Supply Cable, Lemo 1B FGD - Lemo 1B FGL
 - Banana (8mc-8fc+2mc), 3 m Ethernet 3.00 m
 Connection Cable, Lemo 1B FGD - Lemo 1B 9.84 ft CBEP450.1-3 F-00K-105-678
 FGL (8mc-8fc), 3 m

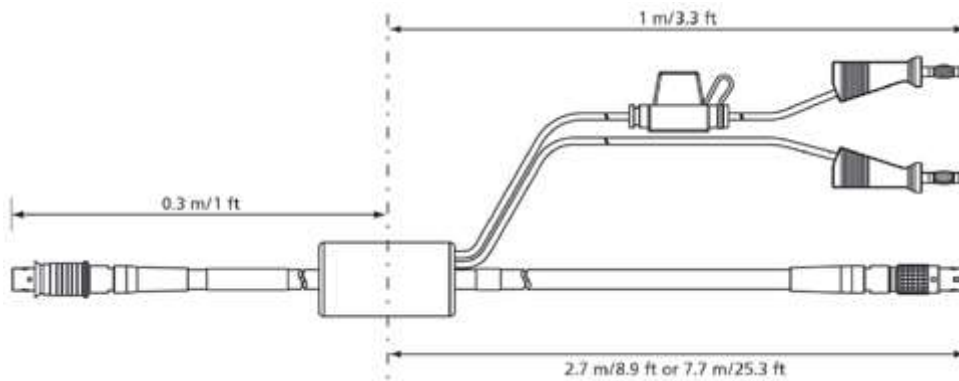

Ethernet Connection Cable (ES4xx/ES63x, ES592, ES593-D, ES595, ES600)

Ethernet and power supply connection of an ES600 Network Module or an ES592/ES593-D/ES595 Interface Module with an ES4xx/ES63x Measurement Module. Rugged water- and dust-proof (IP67).

Ethernet PC Connection Cable, Lemo 1B	3.00 m		
FGF - Lemo 1B FGL (8mc-8fc), 3 m	9.84 ft	CBE400.2-3	F-00K-104-920

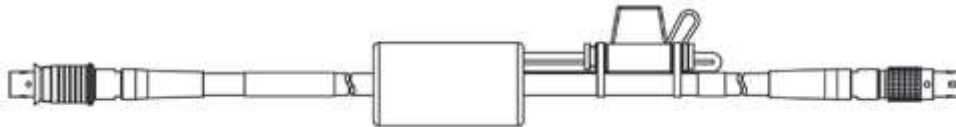

Ethernet PC Connection Cable, Highly Flexible, Lemo 1B FGF - Lemo 1B FGL (8mc-8fc), 0m5	0.50 m		
	1.64 ft	CBE401.1-0m5	F-00K-106-128

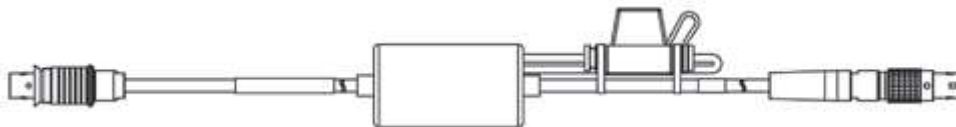

Ethernet Connection and Power Supply Cable (ES4xx/ES63x, ES592, ES593-D, ES595, ES600, ES720, ES1135)

Ethernet and power supply connection of an ES600 Network Module or an ES592/ES593-D/ES595 Interface Module (if current demand of connected ES4xx chain exceeds 2.5 A), an ES1135 Simulation / System Controller Board or an ES720 Drive Recorder with an ES4xx/ES63x Measurement Module. Rugged water- and dust-proof (IP67).

Ethernet Connection and Power Supply Cable, Lemo 1B FGF - Lemo 1B FGL - Banana (8mc-8fc+2mc), 3 m	3.00 m		
	9.84 ft	CBEP420.1-3	F-00K-105-292

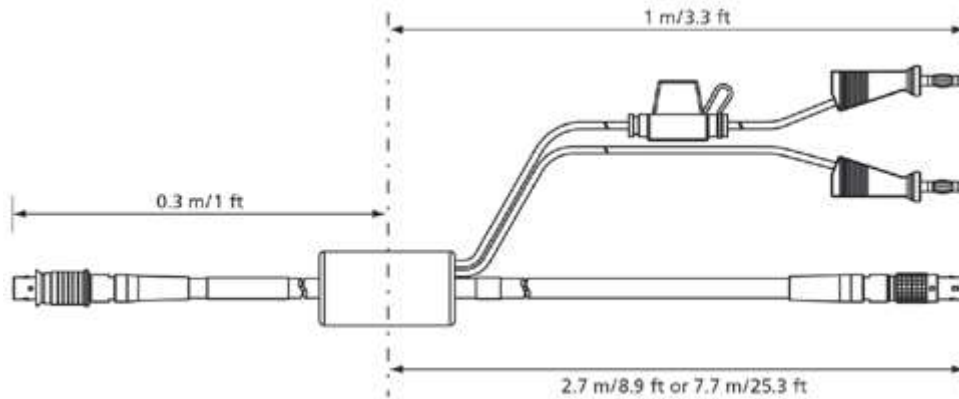

Ethernet Connection and Power Supply
Cable, Lemo 1B FGF - Lemo 1B FGL - Safety
Banana (8mc-8fc+2mc), 3 m

3.00 m	CBEP4205.1-3	F-00K-110-041
9.84 ft		

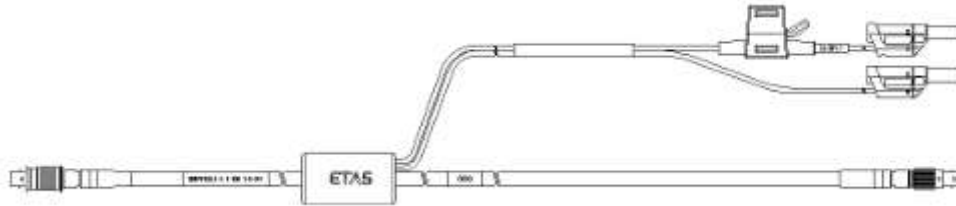

Ethernet Connection and Power Supply
Cable, Lemo 1B FGF - Lemo 1B FGL -
Banana (8mc-8fc+2mc), 3 m

3.00 m	CBEP425.1-3	F-00K-105-972
9.84 ft		

Ethernet Connection and Power Supply
Cable, Lemo 1B FGF - Lemo 1B FGL - Safety
Banana (8mc-8fc+2mc), 3 m

3.00 m	CBEP4255.1-3	F-00K-110-029
9.84 ft		

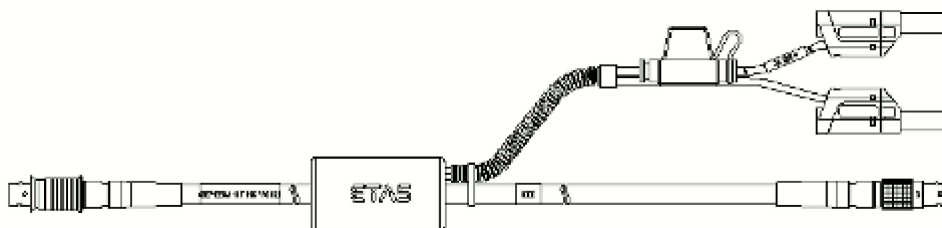

Ethernet Chain Connection and Power Supply Cable (ES4xx/ES63x, ES910)

Used to daisy-chain ES4xx/ES63x modules and to connect an ES4xx/ES63x chain to an ES910 Rapid Prototyping Module. Provides auxiliary connection to power supply to compensate power losses in long chains. Rugged water- and dust-proof (IP67).

Ethernet Chain Connection and Power
Supply Cable, Lemo 1B FGL - Lemo 1B FGA
- Banana (8fc-8mc+2mc), 0m5

0.50 m	CBEP430.1-0m5	F-00K-104-928
1.64 ft		

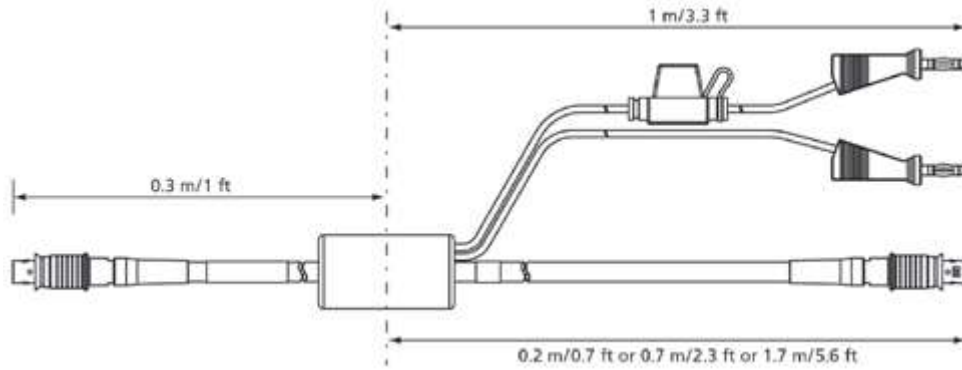

Ethernet Chain Connection and Power Supply Cable, Lemo 1B FGL - Lemo 1B FGA - Safety Banana (8fc-8mc+2mc), 0m5

0.50 m
1.64 ft

CBEP4305.1-0m5 F-00K-110-030

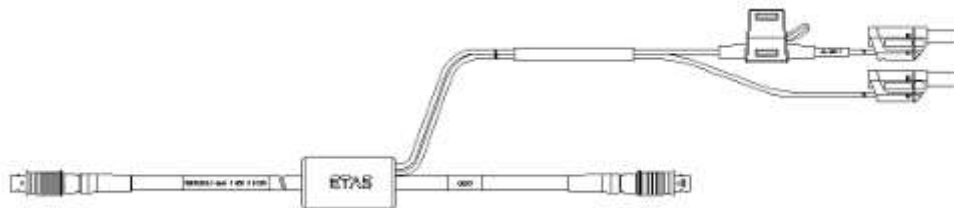

Ethernet Chain Connection Cable (ES4xx/ES63x)

Used to daisy-chain ES4xx/ES63x modules. Rugged water- and dust-proof (IP67).

Ethernet Chain Connection Cable, Lemo 1B FGA - Lemo 1B FGL (8mc-8fc), 0m45

0.45 m
1.48 ft

CBE430.1-0m45 F-00K-104-923

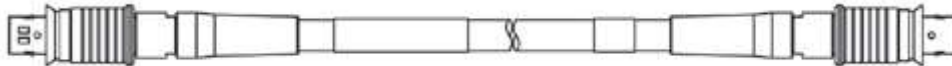

Flexible cable to daisy-chain adjacent ES4xx/ES63x modules. Rugged water- and dust-proof (IP67).

Ethernet Chain Connection Cable, Highly Flexible, Lemo 1B FGA - Lemo 1B FGL (8mc-8fc), 0m14

0.14 m
0.46 ft

CBE431.1-0m14 F-00K-105-676



Ethernet Chain Connection Cable, Highly Flexible, Lemo 1B FGA - Lemo 1B FGL (8mc-8fc), 0m3

0.30 m
0.98 ft

CBE431.1-0m3 F-00K-105-685



Ethernet Chain Connection Bridge (ES4xx)

Bridge to connect two assembled ES4xx modules.

Ethernet Chain Connection Bridge, Lemo
1B FGA - Lemo 1B FGL (8mc-8fc) Bridge to
connect two assembled ES4xx Modules

ES4xx_BRIDGE F-00K-105-684

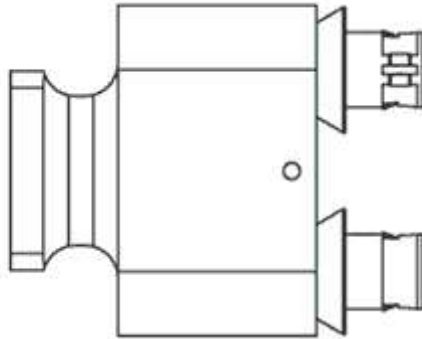

Ethernet Extension Cable (ES4xx/ES63x)

Rugged water- and dust-proof (IP67). Cable for ES4xx/ES63x modules.

Ethernet Extension Cable, Lemo 1B PHL -
Lemo 1B FGL (8mc-8fc), 3 m

3.00 m
9.84 ft

CBEX400.1-3

F-00K-105-294



ETAS Ethernet cable and the corresponding connectors are color coded to guide the user when setting up a measurement configuration.

Custom cables can be produced according to your specifications. For more information on custom cables, please contact your local ETAS sales representative.

